

APJ ABDUL KALAM
TECHNOLOGICAL
UNIVERSITY

SEMESTER VII



Assessment Pattern

Bloom's Category	Continuous Assessment Tests		End Semester Examination (Marks)
	Test 1 (Marks)	Test 2 (Marks)	
Remember			
Understand	25	10	20
Apply		40	50
Analyse	25		30
Evaluate			
Create			

Mark Distribution

Total Marks	CIE Marks	ESE Marks	ESE Duration
150	50	100	3 hours

Continuous Internal Evaluation (CIE) Pattern :

Attendance	: 10 Marks
Continuous Assessment Test (2 numbers)	: 25 Marks
Assignment/Quiz/Course project	: 15 Marks

End Semester Examination (ESE) Pattern: There will be two parts; Part A and Part B. Part A contains 10 questions with 2 questions from each module, having 3 marks for each question. Students should answer all questions. Part B contains 2 questions from each module of which student should answer any one. Each question can have maximum 2 sub-divisions and carry 14 marks.

Course Level Assessment Questions

(Questions may be framed based on the outline given under each course outcome)

Course Outcome 1 (CO1): Explain the behavior and properties of structural steel members to resist various structural forces and actions and apply the relevant codes of practice

1. The fundamental concepts of basic structural behavior in steel structures
2. Basic theories of steel structural members and its analysis.

Course Outcome 2 (CO2): Analyses the behavior of structural steel members and undertake design at both serviceability and ultimate limit states

1. The fundamental concepts of different structural members
2. Design of simple structural members

Course Outcome 3 (CO3): Explain the theoretical and practical aspects of Design of composite Steel Structure along with the planning and design aspects

Design of composite beams and columns

Course Outcome 4 (CO4): Apply a diverse knowledge of Design of Steel engineering practices applied to real life problems

Design of different structural elements considering application aspects

Course Outcome 5 (CO5): Demonstrate experience in the implementation of Design of Structures on engineering concepts which are applied in field Structural Engineering

1. Design engineering problems giving importance to field application

Syllabus

Module	Contents
1	Introduction to steel and steel structures, properties of steel, structural steel sections. Introduction to design: Design loads and load combinations, limit state design concepts. Connections bolted and welded (direct loads)
2	Tension members-Types of sections – net area- design of tension members- concept of shear lag-use of lug angle-connections in tension members
3	Compression members- design of struts- solid and built up columns for axial loads-- design of lacings and battens-column bases- slab base – gusseted base
4	Design of beams- laterally restrained and unrestrained – simple and compound beams- plate girders subjected to uniformly distributed loads – design of stiffeners.
5	Design of roof trusses- types-design loads and load combinations- assessment of wind loads- design of purlins. Moment resistant/Eccentric connections (in plane and out of plane) Fire resistant design-criterion-fire resistance assessment-material property-design approach-passive protection for steel work-fire resistant steel-fire performance assessment

Text Books:

1. Punmia B. C., Jain A. K. and Jain A. K., Design of Steel Structures, Laxmi Publications (P) Ltd, 2017
2. Ramchandra S and Virendra Gehlot, Design of Steel Structures Vol. II, Standard Book House, 2007

References:

1. N.Subramanian; Steel Structures, Oxford Publication
2. P. Dayaratnam., Design of Steel Structures ,Wheeler Publishing, 2003
3. Raghupathi, Steel Structures, Tata McGraw Hill, 2006
4. V L Shah & Veena Gore, Limit State Design of steel Structures , Structures Publications, 2009
5. William T Segui., Steel Design , Cenage Learning, 6e, 2017
6. IS 800 – 2007, Code of practice for Structural steel design, BIS
7. IS:875-Part 3-2015 Design loads for buildings Part 3: Wind loads , BIS



Model Question Paper**QP CODE:****Reg No.:** _____**Name:** _____

APJ ABDUL KALAM TECHNOLOGICAL UNIVERSITY
SEVENTH SEMESTER B.TECH DEGREE EXAMINATION, MONTH & YEAR

Course Code: CET401**Course Name: DESIGN OF STEEL STRUCTURES****(Use of Codes IS 800, IS 875, IS 883 is permitted. Assume suitable data wherever necessary)**

Max. Marks: 100

Duration: 3 hours

Part A*(Answer all questions; each question carries 3 marks)*

1. Explain the failures of bolted joints.
2. What do you mean by prying forces?
3. Under what circumstances do we use slot welds and plug welds?
4. With the help of suitable diagram, explain the concept of shear lag.
5. What are the main purposes of lacings and battens?
6. Explain the failure modes of axially loaded columns.
7. Distinguish between laterally restrained and unrestrained beams.
8. What is lateral torsional buckling of beams?
9. List the different fire resistance criterion.
10. List the various passive protection methods for steel structures against fire.

Part B*(Answer ANY ONE full question from each module, each question carries 14 marks)***Module – 1**

11. Determine the strength and efficiency of a bolted lap joint shown in the figure. The bolts are of 20mm diameter, grade 4.6. The plates are of 12mm thick and grade F2410

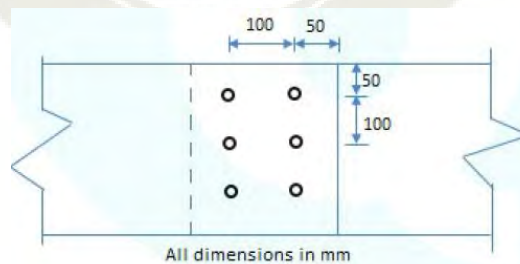

12. An ISMC 250 @ 298kg/m is used as a tie member to transmit a factored load of 800kN. The channel section is connected to a gusset plate of 10mm thickness Design a fillet weld if the lap length is limited to 300mm Provide slot welds if required.

Module – 2

13. Design a tension member to carry an axial factored load of 500kN Use a double angle rolled steel section connected (at site) to each side of a gusset plate of 10mm thick using 20mm diameter bolts of grade 4.6.
14. A tie member consisting of an angle section ISA100x75x8 designed to transfer a factored axial load of 280kN, is to be welded to a gusset plate of 10mm thick using 6mm fillet weld. Design the weld if the weld is provided on three sides by overlapping the angle on the gusset plate at a shop. Also sketch the connection showing the weld lengths.

Module – 3

15. Determine the design compressive load capacity of a column. made of a rolled steel section ISMC 200 @ 217N/m if length of the column is 3m, with both ends fixed.
16. Design a column 10 m long to carry a factored axial load of 1100kN The column is restrained in position but not in direction at both ends. Design a batten system for the column Assume that the two channels are kept back to back

Module – 4

17. Design a simply supported beam of 10m effective span carrying a total factored load of 60kN/m. The depth of beam should not exceed 500mm. The compression flange of beam is laterally supported by floor construction. Assume stiff end bearing is 75mm
18. A conference hall 8m x 12m is provided with a 120 mm RCC slab over rolled steel I beams spaced 4m centre-to-centre. The super imposed load is 4kN/m² and floor finish of 1.5 kN/m². Design one of the beam as laterally supported.

Module – 5

19. A purlin is to be designed to support a GI sheet as roofing material for a truss spaced at 3.5m c/c. purlin along the principal rafters are arranged at a distance of 1.35m c/c. The pitch of truss is 0.2m. Design a section for the purlin. Assume basic wind speed as 44m/s
20. Explain the different fire-resistant design approaches used in steel structures.

Course Contents and Lecture Schedule:

Module	Contents	Course Outcomes Addressed	Hours
1	Module 1		7
1.1	Introduction to steel and steel structures	CO 1	1
1.2	Properties of structural steel and types of Structural steel sections	CO 1	1
1.3	Introduction to design-design philosophies- Design loads and load combinations	CO 1	1
1.4	Connections: Bolted-different types-joints(lap joint, butt joint) - eccentric loaded connections-beam to beam connections	CO 1,CO2	2
1.5	Connections : Welded-different types-joints(lap joint, butt joint) - eccentric loaded connections-beam to beam connections	CO1,CO 2	2
2	Module 2		7
2.1	Introduction- Types of tension members	CO 1	1
2.2	Modes of failure	CO 1	1
2.3	Factors affecting strength of tension members	CO 1	1
2.4	Design of tension members	CO 1 ,CO2	1
2.5	Concept of shear lag	CO 1	1
2.6	Application of lug angle	CO1,CO 3	1
2.7	Connections in tension members	CO 1 & CO 3	1
3	Module 3		7
3.1	Introduction-compression members-classification-Behavior (theory only-No equations)	CO 1	1
3.2	Design of struts	CO 1,CO2	1
3.3	Solid and built up columns for axial loads alone	CO1,CO2, CO 3	1
3.4	Design of lacing system	CO 1,CO3	1
3.5	Design of battening system	CO 1,CO3	1
3.6	Column base plate introduction- Simple slab base plate-only axial	CO 1,CO2	1

	load		
3.7	Gusseted base-only axial load	CO1,CO2, CO 4	1
4	Module 4		7
4.1	Introduction- Beams, design of Laterally restrained beams	CO 1	1
4.2	Laterally Unrestrained beams	CO 1	1
4.3	Design of simple beams	CO 1,CO2	1
4.4	Design of compound beams	CO 1,CO3	1
4.5	Plate girder design for welded connection	CO 1,CO2	1
4.6	Design of stiffeners-end bearing and intermediate stiffeners	CO2,CO 4	1
4.7	Gantry girders AND beam-column (introduction only-No design)	CO 1 & CO 4	1
5	Module 5		7
5.1	Type of roof truss-design loads and load combinations	CO 1	1
5.2	Calculation of wind loads	CO 1 & CO 4	1
5.3	Design of purlins	CO 1, CO2	1
5.4	Moment resistant and eccentric connections-in plane and out of plane-(No design)	CO 1	1
5.5	Introduction –Fire resistance criterion	CO 1	1
5.6	Fire resistance assessment of steel structure-material property at elevated temperature-design approaches and tools-different models-methods-procedures	CO 1, CO2	1
5.7	Passive protection-fire performance assessment	CO1, CO3	1

CEL411	ENVIRONMENTAL ENGG LAB	CATEGORY	L	T	P	CREDIT	YEAR OF INTRODUCTION
		PCC	0	0	3	2	2019

Preamble: This lab provides the knowledge on tests used to analyse the physio-chemical and bacteriological properties of water and explains the various method followed in the test along with its suitability as a drinking water.

Prerequisite: CET 304 Environmental Engineering

Course Outcomes: After the completion of the course, the student will be able to:

Course outcome	Description
CO1	Analyse various physico-chemical and biological parameters of water
CO2	Compare the quality of water with drinking water standards and recommend its suitability for drinking purposes

Mapping of course outcomes with program outcomes:

	PO 1	PO2	PO 3	PO 4	PO 5	PO 6	PO 7	PO 8	PO9	PO1 0	PO1 1	PO12
CO1	3	3	3	1	-	3	3	-	-	-	-	3
CO2	3	3	3	1	-	3	3	-	-	-	-	3

Assessment Pattern:

Mark distribution

Total marks	CIE	ESE	ESE Duration
150	75	75	3 Hrs

Continuous Internal Evaluation (CIE) Pattern:

Attendance	:15 marks
Continuous Assessment	:30 marks
Internal Test	:30 marks

End Semester Examination (ESE) Pattern:

The following guidelines should be followed regarding award of mark

- | | |
|---|------------|
| (a) Preliminary work | : 15 Marks |
| (b) Implementing the work/Conducting the experiment | : 10 Marks |
| (c) Performance, result and inference (usage of equipment and trouble shooting) | : 25 Marks |
| (d) Viva voce | : 20 Marks |
| (e) Record | : 5 Marks |

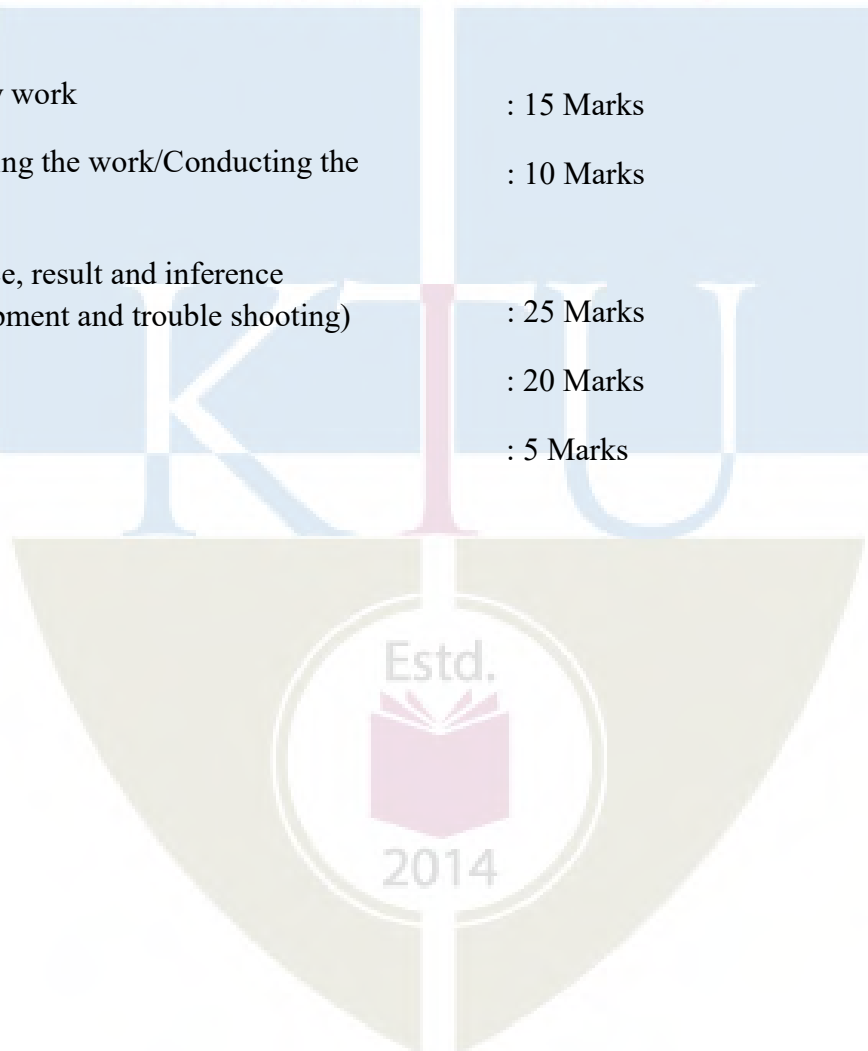

Instructions:

- Any 12 of the 18 experiments included in the list of experiments need to be performed mandatorily.
- Virtual Lab facility cannot be used to substitute the conduct of these mandatory experiments.
- Periodic maintenance and calibration of various testing instruments needs to be made.
- Practical examination to be conducted covering entire syllabus given below. Evaluation is to be conducted under the equal responsibility of both the internal and external examiners. Students shall be allowed for the University examination only on submitting the duly certified record. The external examiner shall endorse the record.

Syllabus

1. Determination of pH, Electrical Conductivity and Turbidity*
2. Determination of TS, TDS and TSS, TVS *
3. Determination of Alkalinity and Acidity *
4. Determination of Hardness *
5. Determination of Chlorides
6. Determination of Total Iron
7. Determination of Biochemical Oxygen Demand*
8. Determination of Chemical Oxygen Demand*
9. Optimum Coagulant dosage*
10. Break point Chlorination *
11. Determination of Available Chlorine in a sample of bleaching powder
12. Determination of Sulphates
13. Determination of Fluoride
14. Determination of Dissolved Oxygen*
15. Determination of nitrates
16. Determination of phosphates
17. Determination of any two Heavy Metal concentration

18. Total coliforms *

Note: * mandatory

References

1. Standard Methods for the Examination of Water and Wastewater, 23rd edition, American Public Health Association, American Water Works Association, Water Environment Federation, 2017.
2. Water Supply Engineering, 33rd edition, Santhosh Kumar Garg, Khanna publishers.
3. Sewage Disposal and Air Pollution Engineering, 39th edition, Santhosh Kumar Garg, Khanna publishers.
4. IS: 10500:2012 Drinking Water - Specification, Second revision, Bureau of Indian Standards, 2012.

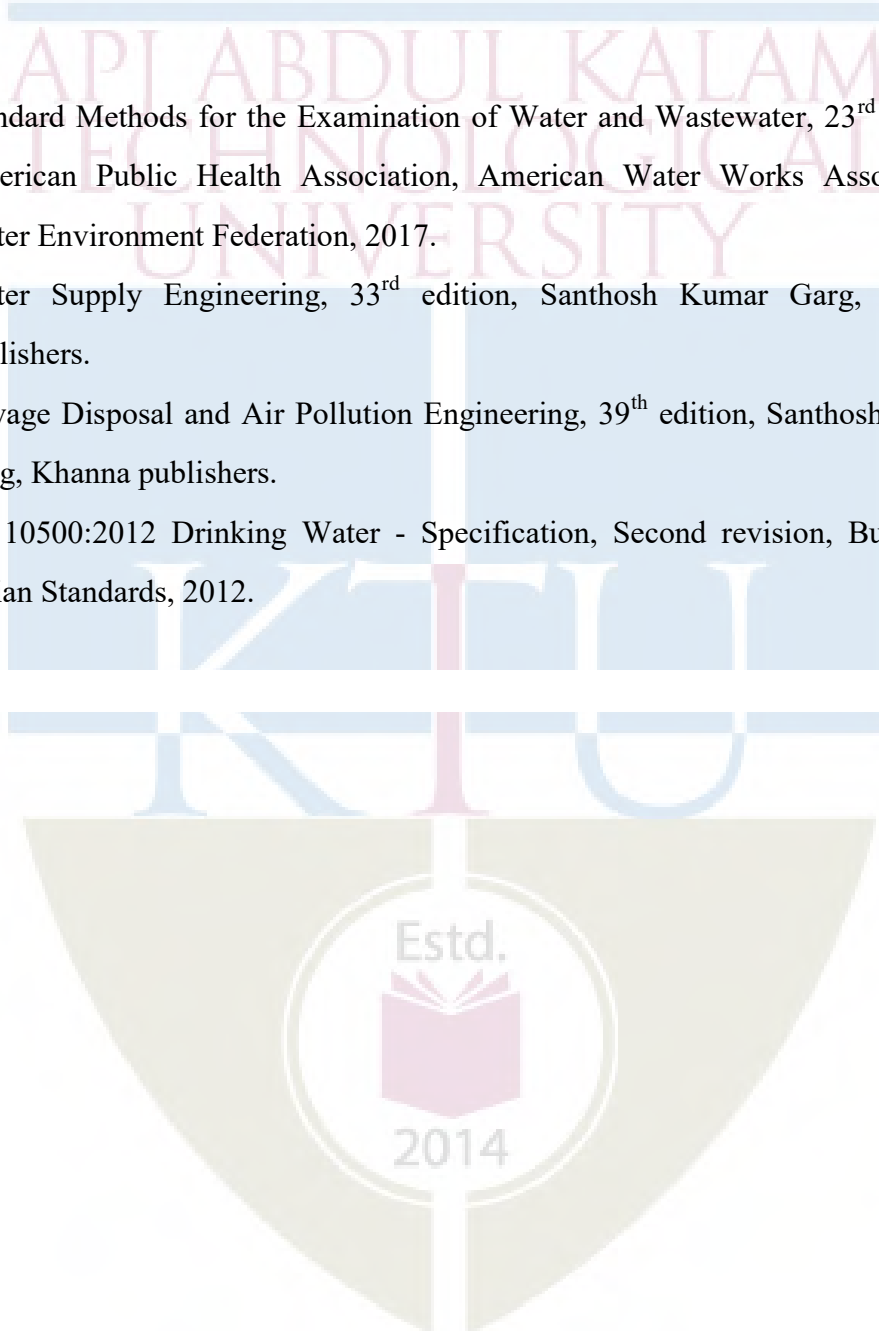

CEQ413	SEMINAR	CATEGORY	L	T	P	CREDIT
		PWS	0	0	3	2

Preamble: The course ‘Seminar’ is intended to enable a B.Tech graduate to read, understand, present and prepare report about an academic document. The learner shall search in the literature including peer reviewed journals, conference, books, project reports etc., and identify an appropriate paper/thesis/report in her/his area of interest, in consultation with her/his seminar guide. This course can help the learner to experience how a presentation can be made about a selected academic document and also empower her/him to prepare a technical report.

Course Objectives:

- To do literature survey in a selected area of study.
- To understand an academic document from the literature and to give a presentation about it.
- To prepare a technical report.

Course Outcomes [COs] : After successful completion of the course, the students will be able to:

CO1	Identify academic documents from the literature which are related to her/his areas of interest (Cognitive knowledge level: Apply).
CO2	Read and apprehend an academic document from the literature which is related to her/ his areas of interest (Cognitive knowledge level: Analyze).
CO3	Prepare a presentation about an academic document (Cognitive knowledge level: Create).
CO4	Give a presentation about an academic document (Cognitive knowledge level: Apply).
CO5	Prepare a technical report (Cognitive knowledge level: Create).

Mapping of course outcomes with program outcomes:

	PO1	PO2	PO3	PO4	PO5	PO6	PO7	PO8	PO9	PO10	PO11	PO12
CO1	2	2	1	1		2	1					3
CO2	3	3	2	3		2	1					3
CO3	3	2			3			1		2		3
CO4	3				2			1		3		3
CO5	3	3	3	3	2	2		2		3		3

Abstract POs defined by National Board of Accreditation

PO#	Broad PO	PO#	Broad PO
PO1	Engineering Knowledge	PO7	Environment and Sustainability
PO2	Problem Analysis	PO8	Ethics
PO3	Design/Development of solutions	PO9	Individual and team work
PO4	Conduct investigations of complex problems	PO10	Communication
PO5	Modern tool usage	PO11	Project Management and Finance
PO6	The Engineer and Society	PO12	Life long learning

General Guidelines

- The Department shall form an Internal Evaluation Committee (IEC) for the seminar with academic coordinator for that program as the Chairperson/Chairman and seminar coordinator & seminar guide as members. During the seminar presentation of a student, all members of IEC shall be present.
- Formation of IEC and guide allotment shall be completed within a week after the University examination (or last working day) of the previous semester.
- Guide shall provide required input to their students regarding the selection of topic/paper.
- Choosing a seminar topic: The topic for a UG seminar should be current and broad based rather than a very specific research work. It's advisable to choose a topic for the Seminar to be closely linked to the final year project area. Every member of the project team could choose or be assigned Seminar topics that covers various aspects linked to the Project area.
- A topic/paper relevant to the discipline shall be selected by the student during the semester break.
- Topic/Paper shall be finalized in the first week of the semester and shall be submitted to the IEC.
- The IEC shall approve the selected topic/paper by the second week of the semester.
- Accurate references from genuine peer reviewed published material to be given in the report and to be verified.

Evaluation pattern

Total marks: 100, only CIE, minimum required to pass 50

Seminar Guide: 20 marks (Background Knowledge – 10 (The guide shall give deserving marks for a candidate based on the candidate's background knowledge about the topic selected), Relevance of the paper/topic selected – 10).

Seminar Coordinator: 20 marks (Seminar Diary – 10 (Each student shall maintain a seminar diary and the guide shall monitor the progress of the seminar work on a weekly basis and shall approve the entries in the seminar diary during the weekly meeting with the student), Attendance – 10).

Presentation: 40 marks to be awarded by the IEC (Clarity of presentation – 10, Interactions – 10 (to be based on the candidate's ability to answer questions during the interactive session of her/his presentation), Overall participation – 10 (to be given based on her/his involvement during interactive sessions of presentations by other students), Quality of the slides – 10).

Report: 20 marks to be awarded by the IEC (check for technical content, overall quality, templates followed, adequacy of references etc.).



CED415	PROJECT PHASE I	CATEGORY	L	T	P	CREDIT
		PWS	0	0	6	2

Preamble: The course ‘Project Work’ is mainly intended to evoke the innovation and invention skills in a student. The course will provide an opportunity to synthesize and apply the knowledge and analytical skills learned, to be developed as a prototype or simulation. The project extends to 2 semesters and will be evaluated in the 7th and 8th semester separately, based on the achieved objectives. One third of the project credits shall be completed in 7th semester and two third in 8th semester. It is recommended that the projects may be finalized in the thrust areas of the respective engineering stream or as interdisciplinary projects. Importance should be given to address societal problems and developing indigenous technologies.

Course Objectives

- To apply engineering knowledge in practical problem solving.
- To foster innovation in design of products, processes or systems.
- To develop creative thinking in finding viable solutions to engineering problems.

Course Outcomes [COs] :After successful completion of the course, the students will be able to:

CO1	Model and solve real world problems by applying knowledge across domains (Cognitive knowledge level: Apply).
CO2	Develop products, processes or technologies for sustainable and socially relevant applications (Cognitive knowledge level: Apply).
CO3	Function effectively as an individual and as a leader in diverse teams and to comprehend and execute designated tasks (Cognitive knowledge level: Apply).
CO4	Plan and execute tasks utilizing available resources within timelines, following ethical and professional norms (Cognitive knowledge level: Apply).
CO5	Identify technology/research gaps and propose innovative/creative solutions (Cognitive knowledge level: Analyze).
CO6	Organize and communicate technical and scientific findings effectively in written and oral forms (Cognitive knowledge level: Apply).

Mapping of course outcomes with program outcomes

	PO1	PO2	PO3	PO4	PO5	PO6	PO7	PO8	PO9	PO10	PO11	PO12
CO1	2	2	2	1	2	2	2	1	1	1	1	2
CO2	2	2	2		1	3	3	1	1		1	1
CO3									3	2	2	1
CO4					2			3	2	2	3	2
CO5	2	3	3	1	2							1
CO6					2			2	2	3	1	1

Abstract POs defined by National Board of Accreditation

PO#	Broad PO	PO#	Broad PO
PO1	Engineering Knowledge	PO7	Environment and Sustainability
PO2	Problem Analysis	PO8	Ethics
PO3	Design/Development of solutions	PO9	Individual and team work
PO4	Conduct investigations of complex problems	PO10	Communication
PO5	Modern tool usage	PO11	Project Management and Finance
PO6	The Engineer and Society	PO12	Lifelong learning

PROJECT PHASE I**Phase 1 Target**

- Literature study/survey of published literature on the assigned topic
- Formulation of objectives
- Formulation of hypothesis/ design/ methodology
- Formulation of work plan and task allocation.
- Block level design documentation
- Seeking project funds from various agencies
- Preliminary Analysis/Modeling/Simulation/Experiment/Design/Feasibility study
- Preparation of Phase 1 report

Evaluation Guidelines & Rubrics

Total: 100 marks (Minimum required to pass: 50 marks).

- Project progress evaluation by guide: 30 Marks.
- Interim evaluation by the Evaluation Committee: 20 Marks.
- Final Evaluation by the Evaluation Committee: 30 Marks.
- Project Phase - I Report (By Evaluation Committee): 20 Marks.

(The evaluation committee comprises HoD or a senior faculty member, Project coordinator and project supervisor).

Evaluation by the Guide

CIVIL ENGINEERING

The guide/supervisor shall monitor the progress being carried out by the project groups on a regular basis. In case it is found that progress is unsatisfactory it shall be reported to the Department Evaluation Committee for necessary action. The presence of each student in the group and their involvement in all stages of execution of the project shall be ensured by the guide. Project evaluation by the guide: 30 Marks. This mark shall be awarded to the students in his/her group by considering the following aspects:

Topic Selection: innovativeness, social relevance etc. (2)

Problem definition: Identification of the social, environmental and ethical issues of the project problem. (2)

Purpose and need of the project: Detailed and extensive explanation of the purpose and need of the project. (3)

Project Objectives: All objectives of the proposed work are well defined; Steps to be followed to solve the defined problem are clearly specified. (2)

Project Scheduling & Distribution of Work among Team members: Detailed and extensive Scheduling with timelines provided for each phase of project. Work breakdown structure well defined. (3)

Literature survey: Outstanding investigation in all aspects. (4)

Student's Diary/ Daily Log: The main purpose of writing daily diary is to cultivate the habit of documenting and to encourage the students to search for details. It develops the students' thought process and reasoning abilities. The students should record in the daily/weekly activity diary the day to day account of the observations, impressions, information gathered and suggestions given, if any. It should contain the sketches & drawings related to the observations made by the students. The daily/weekly activity diary shall be signed after every day/week by the guide. (7)

Individual Contribution: The contribution of each student at various stages. (7)

EVALUATION RUBRICS for PROJECT Phase I: Interim Evaluation

No.	Parameters	Marks	Poor	Fair	Very Good	Outstanding
1-a	Topic identification, selection, formulation of objectives and/or literature survey. (Group assessment) [CO1]	10	The team has failed to come with a relevant topic in time. Needed full assistance to find a topic from the guide. They do not respond to suggestions from the evaluation committee and/or the guide. No literature review was conducted. The team tried to gather easy information without verifying the authenticity. No objectives formed yet.	The team has identified a topic. The originally selected topic lacks substance and needs to be revised. There were suggestions given to improve the relevance and quality of the project topic. Only a few relevant references were consulted/ studied and there is no clear evidence to show the team's understanding on the same. Some objectives identified, but not clear enough.	Good evidence of the group thinking and brainstorming on what they are going to build. The results of the brainstorming are documented and the selection of topic is relevant. The review of related references was good, but there is scope of improvement. Objectives formed with good clarity, however some objectives are not realistic enough.	The group has brainstormed in an excellent manner on what they were going to build. The topic selected is highly relevant, real world problem and is potentially innovative. The group shows extreme interest in the topic and has conducted extensive literature survey in connection with the topic. The team has come up with clear objectives which are feasible.
			(0 – 3 Marks)	(4 – 6 Marks)	(7 - 9 Marks)	(10 Marks)
1-b	Project Planning, Scheduling and Resource/ Tasks Identification and allocation. (Group assessment) [CO4]	10	No evidence of planning or scheduling of the project. The students did not plan what they were going to build or plan on what materials / resources to use in the project. The students do not have any idea on the budget required. The team has not yet decided on who does what. No project journal kept.	Some evidence of a primary plan. There were some ideas on the materials /resources required, but not really thought out. The students have some idea on the finances required, but they have not formalized a budget plan. Schedules were not prepared. The project journal has no details. Some evidence on task allocation among the team members.	Good evidence of planning done. Materials were listed and thought out, but the plan wasn't quite complete. Schedules were prepared, but not detailed, and needs improvement. Project journal is presented but it is not complete in all respect / detailed. There is better task allocation and individual members understand about their tasks. There is room for improvement.	Excellent evidence of enterprising and extensive project planning. Gantt charts were used to depict detailed project scheduling. A project management/version control tool is used to track the project, which shows familiarity with modern tools. All materials / resources were identified and listed and anticipation of procuring time is done. Detailed budgeting is done. All tasks were identified and incorporated in the schedule. A well-kept project journal shows evidence for all the above, in addition to the interaction with the project guide. Each member knows well about their individual tasks.
			(0 – 3 Marks)	(4 – 6 Marks)	(7 - 9 Marks)	(10 Marks)
Phase 1 Interim Evaluation Total Marks: 20						

EVALUATION RUBRICS for PROJECT Phase I: Final Evaluation

Sl. No.	Parameters	Marks	Poor	Fair	Very Good	Outstanding
1-c	Formulation of Design and/or Methodology and Progress. (Group assessment) [CO1]	5	None of the team members show any evidence of knowledge about the design and the methodology adopted till now/ to be adopted in the later stages. The team has not progressed from the previous stage of evaluation.	The students have some knowledge on the design procedure to be adopted, and the methodologies. However, the team has not made much progress in the design, and yet to catch up with the project plan.	The students are comfortable with design methods adopted, and they have made some progress as per the plan. The methodologies are understood to a large extent.	Shows clear evidence of having a well- defined design methodology and adherence to it. Excellent knowledge in design procedure and its adaptation. Adherence to project plan is commendable.
			(0 – 1 Marks)	(2 – 3 Marks)	(4 Marks)	(5 Marks)
1-d	Individual and Teamwork Leadership (Individual assessment) [CO3]	10	The student does not show any interest in the project activities, and is a passive member.	The student show some interest and participates in some of the activities. However, the activities are mostly easy and superficial in nature.	The student shows very good interest in project, and takes up tasks and attempts to complete them. Shows excellent responsibility and team skills. Supports the other members well.	The student takes a leadership position and supports the other team members and leads the project. Shows clear evidence of leadership.
			(0 – 3 Marks)	(4 – 6 Marks)	(7 - 9 Marks)	(10 Marks)
1-e	Preliminary Analysis/ Modeling / Simulation/ Experiment / Design/ Feasibility study [CO1]	10	The team has not done any preliminary work with respect to the analysis/modeling/ simulation/experiment/design/feasibility study/ algorithm development.	The team has started doing some preliminary work with respect to the project. The students however are not prepared enough for the work and they need to improve a lot.	There is some evidence to show that the team has done good amount of preliminary investigation and design/ analysis/ modeling etc. They can improve further.	Strong evidence for excellent progress in the project. The team has completed the required preliminary work already and are poised to finish the phase I in an excellent manner. They have shown results to prove their progress.
			(0 – 3 Marks)	(4 – 6 Marks)	(7 - 9 Marks)	(10 Marks)

1-f	Documentation and presentation. (Individual & group assessment). [CO6]	5	<p>The team did not document the work at all. The project journal/diary is not presented. The presentation was shallow in content and dull in appearance. The individual student has no idea on the presentation of his/her part.</p>	<p>Some documentation is done, but not extensive. Interaction with the guide is minimal. Presentation include some points of interest, but overall quality needs to be improved. Individual performance to be improved.</p>	<p>Most of the project details were documented well enough. There is scope for improvement. The presentation is satisfactory. Individual performance is good.</p>	<p>The project stages are extensively documented in the report. Professional documentation tools like LaTeX were used to document the progress of the project along with the project journal. The documentation structure is well-planned and can easily grow into the project report.</p> <p>The presentation is done professionally and with great clarity. The individual's performance is excellent.</p>
			(0 – 1 Marks)	(2 – 3 Marks)	(4 Marks)	(5 Marks)
Total		30	Phase - I Final Evaluation Marks: 30			

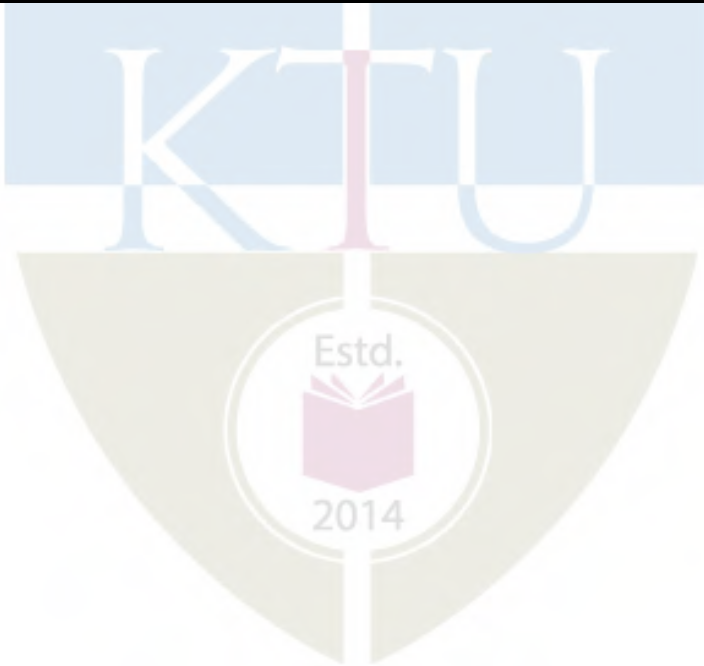

EVALUATION RUBRICS for PROJECT Phase I: Report Evaluation

Sl. No.	Parameters	Marks	Poor	Fair	Very Good	Outstanding
1-g	Report [CO6]	20	The prepared report is shallow and not as per standard format. It does not follow proper organization. Contains mostly Unacknowledged content. Lack of effort in preparation is evident.	Project report follows the standard format to some extent. However, its organization is not very good. Language needs to be improved. All references are not cited properly in the report.	Project report shows evidence of systematic documentation. Report is following the standard format and there are only a few issues. Organization of the report is good. Most of references are cited properly.	The report is exceptionally good. Neatly organized. All references cited properly. Diagrams/Figures, Tables and equations are properly numbered, and listed and clearly shown. Language is excellent and follows standard styles.
			(0 - 7 Marks)	(8 - 12 Marks)	(13 - 19 Marks)	(20 Marks)
Phase - I Project Report Marks: 20						



APJ ABDUL KALAM
TECHNOLOGICAL
UNIVERSITY

SEMESTER VII
PROGRAM ELECTIVE II



Assessment pattern

Bloom's Category	Continuous Assessment Tests		End Semester Examination (Marks)
	Test 1 (Marks)	Test 2 (Marks)	
Remember	5	5	10
Understand	10	10	20
Apply	15	15	30
Analyze	20	20	40
Evaluate			
Create			

Continuous Internal Evaluation Pattern:

Attendance	:	10 marks
Continuous Assessment Test (2 numbers)	:	25 marks
Assignment/Course project	:	15 marks
Total	:	50 marks

End semester examination pattern – There will be two parts; Part A and Part B. Part A contain 10 questions with 2 questions from each module, having 3 marks for each question. Students should answer all questions. Part B contains 2 questions from each module of which student should answer any one. Each question can have maximum 2 sub-divisions and carry 14 marks.

Course Level Assessment (Sample) Questions

CO1: Explain the concepts of prestressing and analyze prestressed concrete members for stresses and losses.

1. What are the advantages of prestressed concrete members?
2. What is the need of high strength concrete and steel?
3. Explain different prestressing systems with figures.
4. What do you mean by stress concept while analyzing prestressed systems?
5. Explain the load balancing concept for extreme fiber stresses for parabolic tendon profile.
6. Explain the losses of prestress in prestressed concrete
7. A rectangular concrete beam, 100 mm wide by 250 mm deep spanning over 8 m is prestressed by a straight cable carrying an effective prestressing force of 250 kN located at an eccentricity of 40 mm. The beam supports a live load of 1.2 kN/m. Calculate the resultant stress distributing for the central cross section of the beam. The density of concrete is 24 kN/m³.

CO2: Analyze for flexure, shear and torsional resistance of PSC members.

1. A concrete beam of rectangular section, 300 mm wide and 800 mm deep is subjected to a twisting moment of 30 kNm and a prestressing force of 150 kN acting at an eccentricity of 220 mm. Calculate the maximum principal tensile stress. If the beam is subjected to a bending moment of 100 kNm in addition to the twisting moment, calculate the maximum principal tensile stress.
2. Explain with neat sketches the types of shear cracks in structural concrete members.
3. A concrete beam of rectangular section, 300 mm wide and 800 mm deep is subjected to a twisting moment of 30 kNm and a prestressing force of 150 kN acting at an eccentricity of 220 mm. i) Calculate the maximum principal tensile stress. ii) If the beam is subjected to a maximum bending moment of 100 kNm in addition to the twisting moment, calculate the maximum principal tensile stress

CO3: Design pre-tensioned and post-tensioned members symmetrical about vertical axis.

1. A post tensioned prestressed concrete beam for the roof of an industrial structure has a simply supported span of 25 m. The beam has to support a dead load of 2 kN/m together with an imposed load of 15 kN/m in addition to the self-weight. The grade of concrete is M40 and the compressive strength of concrete at transfer is 35 N/mm^2 . The loss ratio is 0.80. The 64 mm cables containing 7-15 mm strands with an ultimate load capacity of 1750 kN are available. Use IS 1343 provisions, design the cross section of the girder to comply with various limit states. Sketch the details of cables in the cross-section and the profile of cables along the depth and length of the beam.
2. A prestressed concrete beam of rectangular cross-section is subjected to an effective prestressing force of 500 kN provided by 5 numbers of 12.5 mm diameter strands of cross-sectional area 506 mm^2 . The cross-sectional dimension of the beam is $450 \text{ mm} \times 600 \text{ mm}$. The eccentricity of the posttensioned tendon is 150 mm. A service load Bending Moment of 176 kNm, Torsional Moment of 56 kNm and Shear Force of 75kN are acting at the section of the beam. Take the cube strength of concrete as 40 N/mm^2 and the ultimate tensile strength of tendons as 1820 N/mm^2 . Using IS 1343 codal provisions design the longitudinal and transverse reinforcements of the beam.

CO4: Analyse the deflections of prestressed concrete members.

1. A prestressed concrete beam spanning over 8 m is of rectangular section, 150 mm wide and 300 mm deep. The beam is prestressed by a parabolic cable having an eccentricity of 75 mm below the centroidal axis at the centre of span and an eccentricity of 25 mm above the centroidal axis at the support sections. The initial force in the cable is 350 kN. The beam supports 3 concentrated loads of 10 kN each at intervals of 2m. Assume any missing values. a) Neglecting losses of prestress, estimate the short-term deflection due to (Prestress + self-weight) and b) Allowing for 20 percent loss in prestress, estimate the

long-term deflection under (prestress + self-weight +live load) assuming creep coefficient at 1.80.

2. A PSC beam of breadth 240 mm and depth 300 mm is S.S. on an effective span of 6 m. It is prestressed by parabolic cable with an eccentricity of 75mm below the centroid at the mid span section and 45 mm above centroid at the support section. Prestressing force is 480 kN. Calculate the initial mid-span deflection. Assume the unit weight of concrete as 25 kN/m² and modulus of elasticity of concrete as 2.5×10^4 MPa.
3. A PSC beam of span 8m has the following data: Area = 32×10^3 mm², $E = 38$ kN/m², width of gyration 72 mm Cable: parabolic, 6 wires of 7 mm HTS, concentric at supports and eccentric by 50mm at mid span. $F_{pe} = 1000$ N/mm² Determine the deflection for the following cases:
 - i) Self-weight+ Prestress
 - ii) Self-weight +Prestress +Live load of 3 kN/m.

CO5: Analyze the transfer of prestress in pretensioned members, anchorage zone stresses in post tensioned members.

1. Explain the process of transferring of prestress in pretensioned members.
2. What are anchorage zones in post tensioned member?
3. What do you mean by bursting force?
4. Explain the end block designing.
5. Design the bearing plate and the end zone reinforcement for the following bonded post-tensioned beam. The strength of concrete at transfer is 50 MPa. A pre-stressing force of 1055 kN is applied by a single tendon. There is no eccentricity of the tendon at the ends.

CO6: Analyze prestressing of statically indeterminate structures and design continuous members.

1. What are the advantages of using continuous members in prestressed concrete structures?
2. Distinguish between primary moment and secondary moment in the context of prestressing of statically indeterminate structures.
3. A two-span continuous beam ABC ($AB = BC = 10$ m) is of rectangular section 200 mm wide and 500 mm deep. The beam is prestressed by a parabolic cable, concentric at end supports and having an eccentricity of 100 mm towards the soffit of the beam at centre of spans and 200 mm towards the top of beam at mid support B. The effective force in the cable is 500 kN. a) Show that the cable is concordant. b) Locate the pressure line in the beam when it supports an imposed load of 5.6 kN/m in addition to its self-weight.

CO7: Analyze composite construction of prestressed and in situ concrete.

1. What are the advantages of using precast prestressed units in association with the in-situ concrete?
2. Distinguish between propped and unpropped construction methods in composite construction using stress diagrams at various stages of construction.
3. A rectangular pretensioned concrete beam has a breadth of 100 mm and depth 230 mm and the prestress after all losses have occurred is 12 N/sq.mm at the soffit and zero at the top.

The beam is incorporated in a composite I beam by casting a top flange of breadth 300 mm and depth 50 mm. Calculate the maximum uniformly distributed live load that can be supported on a simply supported span of 4.5m, without any tensile stresses occurring, a) if the slab is externally supported while casting and b) if the pretensioned beam supports the weight of the slab while casting.

- Specify the various steps involved in the design of composite sections.

CO8: Analyze and design PSC slabs.

- What are the different types of Prestressed concrete slabs?
- Design a post-tensioned prestressed concrete two-way slab 6 m by 8 m in size to support a live load of 3 kN/m². If cables of four wires of 5 mm diameter stressed to 1000 N/mm² are available for use, determine the number of cables in the two principal directions. The stresses in concrete not to exceed 14 N/mm² in compression and tensile stresses are not permitted under service loads. The loss ratio is 0.8. Check for the limit state of serviceability and collapse.

Syllabus

Module I

Basic concept and principles of pre-stressed concrete; Prestressing: - Pre tensioning and Post tensioning, Thermo elastic and Chemical prestressing. Need of high strength concrete and steel, Advantages of prestressed concrete over reinforced concrete, Different prestressing systems; Analysis of prestress and bending stress: - Stress concept, Strength concept: - Pressure line and internal resisting couple and Load balancing concept for extreme fiber stresses for various tendon profile.

Losses of Prestress: Stages of losses, Types of losses in pre-tensioning and post-tensioning due to Elastic shortening, Shrinkage, Creep, Relaxation, Anchorage Slip, Friction and Sudden changes in temperature; Loss of pre-stress Stresses at transfer and service loads.

Module II

Flexural strength: - Codal provision for Limit state design, Design stress strain curve for concrete. Design of sections for flexure: - Expressions for minimum section modulus, Prestressing force, and Eccentricity. Limiting zone for prestressing force.

Shear Resistance of PSC members: - Shear and Principal stresses, Ultimate shear resistance of PSC members: - Section cracked and uncracked, Design for shear using IS code.

Torsional Resistance of PSC members: - Pure torsion, Combined bending moment and torsion, Combined bending moment, shear and torsion, Design of reinforcement using IS code provision.

Module III**Design of Pretensioned and Post-Tensioned Flexural Members:**

Dimensioning of Flexural members, Estimation of Self Weight of Beams, Design of Pre tensioned and Post tensioned members symmetrical about vertical axis;

Deflections of prestressed concrete members: Importance, factors, short term and long term deflection. Codal provisions.

Module IV

Transfer of Prestress in Pretensioned members : Transmission length, Bond stresses, Transverse Tensile Stresses, End-Zone reinforcement, Flexural bond stresses, Code Provisions

Anchorage zone Stresses in post tensioned members : Stress distribution in end block, Methods of investigation, Anchorage zone reinforcements, Design (IS Code method only).

Module V

Prestressing of statically indeterminate structures: Advantages, Effect, Method of achieving continuity, Primary, Secondary and Resultant moments, Pressure line, Concept of Linear transformation, Guyon's theorem, Concordant cable profile and its determination. Design of Continuous Prestressed beams

Composite construction of Prestressed and in situ Concrete:

Types of composite construction, Analysis of stresses, Flexural strength.

PSC Slabs - Types, Design and analysis of PSC One-way and two way slabs.

Text Books

1. Krishna Raju.N,(2012) "*Prestressed Concrete*", 4th Edition, Tata McGraw Hill Publishing Co. New Delhi.
2. Dayaratnam.P.(2012), "*Prestressed Concrete*", Tata McGraw Hill Publishing Co. New Delhi
3. Sinha .N.C & S.K. Roy,(1985) "*Fundamentals of Prestressed Concrete*, S.Chand & Co.
4. Rajagopalan.N.(2010) "*Prestressed Concrete*", Narosa Publishing House, New Delhi.

References:

1. Lin .T.Y. (2010)"*Design of Prestressed Concrete Structures*", John Wiley and Sons - Inc
2. Leonhardt.F. (1964),"*Prestressed Concrete Design and Construction*", - Second Edition Wilhelm Ernst & Sohn, Berlin.
3. Guyon .V.(1995), "*Limit State Design of Prestressed Concrete*", - Vol - 1 & 2, Applied Science Publishers, London
4. Mallick and Rangaswamy., (2014),"*Mechanics of Prestressed Concrete Design* ", Khanna Publishers.
5. Pandit & Gupta., " *Prestressed Concrete* ", CBS Publishers

6. F.K. Hong & R.H. Evans., (2007), "*Reinforced and Prestressed Concrete* " Tata McGraw Hill Co.
7. Abeles, P. W., "*The Principles and Practice of Prestressed Concrete*", Crosby Lockwood and Sons, 1949.
8. Collins, M. P. and Mitchell, D., "*Prestressed Concrete Structures*", Prentice-Hall, Inc., 1991.
9. Magnel, G., "*Prestressed Concrete*", Concrete Publications, 1948.
10. Nawy, E. G., "*Prestressed Concrete – A Fundamental Approach*", 5th Edition, Prentice-Hall, Inc., 2006.
11. Nilson, A., "*Design of Prestressed Concrete*", 2nd Edition, John Wiley & Sons, 1987.

Reference codes

Codes The codes related with prestressed concrete are listed below according to the publishing agencies.

Bureau of Indian Standards

IS:784 - 2001 Prestressed Concrete Pipes (Including Fittings) - Specification

IS:1343 - 1980 Code of Practice for Prestressed Concrete

IS:1678 - 1998 Specification for Prestressed Concrete Poles for Overhead Power, Traction and Telecommunication Lines

IS:1785 - 1983 Specification for Plain Hard Drawn Steel Wire for Prestressed Concrete

Part-1: Cold-drawn Stress-relieved wire

Part-2: As-drawn wire

IS: 2090 - 1983 Specification for High Tensile Steel Bars Used in Prestressed Concrete

IS:2193 - 1986 Specification for Precast Prestressed Concrete Steel Lighting Poles

IS:3370 - 1967 Code of Practice for Concrete Structures for Storage of Liquids

Part-3: Prestressed Concrete Structures

IS:6003 - 1983 Specification for Indented Wire for Prestressed Concrete

IS:6006 - 1983 Specification for Uncoated Stress Relieved Strand for Prestressed Concrete

IS:6461 - 1973 Glossary of Terms Relating to Cement Concrete

Part 11: Prestressed Concrete

IS:10790 - 1984 Methods of Sampling of Steel for Prestressed and Reinforced Concrete

Part-1: Prestressing Steel

Part-2: Reinforcing Steel Prestressed Concrete Structures Dr. Amlan K Sengupta and Prof. Devdas Menon Indian Institute of Technology Madras

IS:13158 - 1991 Specification for Prestressed Concrete Circular Spun Poles for Overhead Power, Traction and Telecommunication Lines

IS: 14268 - 1995 Specification for Uncoated Stress Relieved Low Relaxation Seven Ply Strand for Prestressed Concrete

American Concrete Institute, USA

ACI 318M-05, Building Code Requirements for Structural Concrete and Commentary.

British Standard Institution, UK

BS 8110 : Part 1 : 1997, Structural Use of Concrete : Part 1 Code of Practice for Design and Construction.

Council of Standards Australia

AS 3600 Concrete Structures 2001.

European Committee for Standardisation

EN 1992 Design of Concrete Structures, 2005.

Handbook

PCI Design Handbook, 5th Edition published by the Precast/Prestressed Concrete Institute, USA

Course Contents and Lecture Schedule

Module	Topic	Course outcome addressed	No of Hours
Module I (7 Hours)			
1.1	Basic concept and principles of pre-stressed concrete; Prestressing: - Pre tensioning and Post tensioning, Thermo elastic and Chemical prestressing. Need of high strength concrete and steel	CO1	1
1.2	Advantages of prestressed concrete over reinforced concrete, Different prestressing systems	CO1	1
1.3	Analysis of prestress and bending stress: - Stress concept, Strength concept: - Pressure line and internal resisting couple	CO1	1
1.4	Load balancing concept for extreme fiber stresses for various tendon profile	CO1	1
1.5	Losses of Prestress: Stages of losses, Types of losses in pre-tensioning and post-tensioning	CO1	1
1.6	Losses due to Elastic shortening, Shrinkage, Creep, Relaxation, Anchorage Slip, Friction and Sudden changes in temperature	CO1	1

1.7	Loss of pre-stress Stresses at transfer and service loads	CO1	1
Module II (7 Hours)			
2.1	Flexural strength: - Codal provision for Limit state design, Design stress strain curve for concrete. Design of sections for flexure: - Expressions for minimum section modulus,	CO2	2
2.2	Prestressing force, and Eccentricity. Limiting zone for prestressing force.	CO2	1
2.3	Shear Resistance of PSC members: - Shear and Principal stresses, Ultimate shear resistance of PSC members: - Section cracked and uncracked	CO2	1
2.4	Design for shear using IS code. Torsional Resistance of PSC members: - Pure torsion, Combined bending moment and torsion	CO2	1
2.5	Combined bending moment, shear and torsion modes of failure	CO2	1
2.6	Design of torsion reinforcement using IS code provision	CO2	1
Module III (7 Hours)			
3.1	Design of Pretensioned and Post-Tensioned Flexural Members: Dimensioning of Flexural members, Estimation of Self Weight of Beams	CO3	1.5
3.2	Design of Pre tensioned and Post tensioned members symmetrical about vertical axis	CO3	1.5
3.3	Deflections of prestressed concrete members: Importance, factors	CO4	1
3.4	Short term deflections	CO4	1.5
3.5	Long term deflection. Codal provisions	CO4	1.5
Module IV (7 Hours)			
4.1	Transfer of Prestress in Pretensioned members - Introduction	CO5	1
4.2	Transmission length, Bond stresses	CO5	1
4.3	Transverse Tensile Stresses, End-Zone reinforcement,	CO5	1
4.4	Flexural bond stresses, Code Provisions	CO5	1
4.5	Anchorage zone Stresses in post tensioned members : Stress distribution in end block, Methods of investigation	CO5	1

4.6	Anchorage zone reinforcements, Design (IS Code method only)	CO5	2
Module V (7 Hours)			
5.1	Prestressing of statically indeterminate structures: Advantages, Effect, Method of achieving continuity, Primary, Secondary and Resultant moments	CO6	1
5.2	Pressure line, Concept of Linear transformation, Guyon's theorem, Concordant cable profile and its determination	CO6	1
5.3	Design of Continuous Prestressed beams	CO6	1
5.4	Composite construction of Prestressed and in situ Concrete: Types of composite construction	CO7	1
5.5	Composite construction: Analysis of stresses, Flexural strength	CO7	1
5.6	PSC Slabs - Types, Design and analysis of PSC One-way slabs	CO8	1
5.7	Design and analysis of PSC two-way slabs	CO8	1



Model Question Paper**QP CODE:****Reg No.:** _____**Name:** _____

APJ ABDUL KALAM TECHNOLOGICAL UNIVERSITY
SEVENTH SEMESTER B.TECH DEGREE EXAMINATION, MONTH & YEAR

Course Code: CET 413**Course Name: Prestressed Concrete**

Max. Marks: 100

Duration: 3 hours

Part A*(Answer all questions; each question carries 3 marks)*

Qn No	Question	Marks	Course outcome (CO) Assessed
	Part A (Answer ALL Questions)		
1	Discuss the merits and demerits of prestressed concrete	3	CO1
2	Distinguish between pretensioned and post-tensioned members	3	CO1
3	List the various types of losses of prestress in pretensioned and post-tensioned members	3	CO1
4	What are the various modes of failures in prestressed concrete beams due to shear and torsion?	3	CO2
5	What do you mean by concordant cable profile	3	CO6
6	List the various factors which influence the deflection in prestressed concrete members.	3	CO4
7	What are the different types of composite structures?	3	CO7
8	What is the necessity of providing reinforcements in the anchorage zone of a prestressed concrete beam? Give the supporting figures	3	CO5
9	Briefly explain the importance of creep and shrinkage of concrete in long-term deflections of prestressed members.	3	CO4
10	How does the prestress gets transferred to the member in pretensioned members.	3	CO5

	b) A pretensioned girder having a T-section is made up of a flange 200 mm wide and 60 mm thick. The overall depth of the girder is 600 mm. The thickness of the web is 60 mm. The horizontal prestress at a point 300 mm from the soffit is 10 N/mm ² . The shear stress due to transverse load acting at the same point is 2.5 N/mm ² . Determine the increase in the principal tensile stress at this point if the T-section is subjected to a torque of 2 kN-m	7	CO2
14	a) The horizontal prestress at the centroid of a concrete beam of rectangular cross section 340mm by 600mm, is 10N/mm ² and maximum shearing force on the beam is 90kN. Calculate the maximum principal tensile stress	6	CO2
	b) A concrete beam of rectangular section, 300 mm wide and 800 mm deep is subjected to a twisting moment of 30 kNm and a prestressing force of 150 kN acting at an eccentricity of 220 mm. i) Calculate the maximum principal tensile stress. ii) If the beam is subjected to a maximum bending moment of 100 kNm in addition to the twisting moment, calculate the maximum principal tensile stress.	8	CO2
	Module III		
15	a) A beam of size 200 mm × 350 mm is prestressed with 12 wires of 7 mm diameter straight tendons located at a distance of 75 mm from the soffit of the beam. The wires are stressed to 750 N/mm ² . The beam supports an imposed load of 7 kN/m over a span of 8 m. The modulus of elasticity of concrete is 38 kN/mm ² , and density of concrete is 24 kN/m ³ . Estimate the central deflection of the beam under the action of prestress, self-weight and live load. Compare this value with IS 1343 codal provisions	9	CO4
	b) A concrete beam is prestressed by a sloping tendon having an eccentricity of e ₁ towards the soffit at centre of span and an eccentricity of e ₂ towards the top at supports. Find the ratio of these eccentricities for zero deflection at the centre of span due to prestress only.	5	CO4
16	A prestressed concrete beam of rectangular cross-section is subjected to an effective prestressing force of 500 kN provided by 5 numbers of 12.5 mm diameter strands of cross-sectional area	14	CO3

	506 mm ² . The cross-sectional dimension of the beam is 450 mm × 600 mm. The eccentricity of the posttensioned tendon is 150 mm. A service load Bending Moment of 176 kNm, Torsional Moment of 56 kNm and Shear Force of 75kN are acting at the section of the beam. Take the cube strength of concrete as 40N/mm ² and the ultimate tensile strength of tendons as 1820 N/mm ² . Using IS 1343 codal provisions design the longitudinal and transverse reinforcements of the beam.		
	Module IV		
17	<p>a) Estimate the transmission length at the ends of a pretensioned beam prestressed by 7-mm diameter wires. Assume the cube strength of concrete at transfer as 42 N/mm² .</p> <p>b) A pretensioned beam is prestressed using 5 mm diameter wires with an initial stress of 80 percent of the ultimate tensile strength of steel ($f_{pu} = 1600 \text{ N/mm}^2$). The cube strength of concrete at transfer is 30 N/mm² . (a) Calculate the transmission length (b) compute the bond stress at $\frac{1}{4}$ and $\frac{1}{2}$ the transmission length from the end and (c) Calculate the overall average bond stress.</p>	9	CO5
		5	CO5
18	The end block of a post tensioned concrete beam 300 mm×300 mm is subjected to a concentric anchorage force of 800 kN by a freyssinet anchorage system of area 1100mm ² . Design, Discuss and detail the anchorage reinforcement for the end block.	14	CO5
	Module V		
19	The floor slab of an industrial structure, spanning over 8 m is to be designed as a one-way prestressed concrete slab with parallel post-tensioned cables. The slab is required to support a live load of 10 kN/sq.m with the compressive and tensile stress in concrete at any stage not exceeding 14 and zero 14 kN/sq.m respectively. Design a suitable thickness for the slab and estimate the maximum horizontal spacing of the Freyssinet cables (12 of 5 mm diameter initially stressed to 1200 N/sq.mm) and their position at mid span section. The loss ratio is 0.8.	14	CO8

CET423	GROUND IMPROVEMENT TECHNIQUES	CATEGORY	L	T	P	CREDIT	YEAR OF INTRODUCTION
		PEC	3	0	0	3	2019

Preamble: The course introduces the various types ground improvement techniques that can be adopted in different site conditions. It enables the students to choose the suitable ground improvement techniques to be adopted depends on the site condition and requirements.

Prerequisite: Geotechnical Engineering-I, Geotechnical Engineering-II

Course Outcomes: After the completion of the course the student will be able to

Course Outcome	Description of Course Outcome
CO1	Classify different ground improvement methods based on the soil suitability
CO2	Outline the basic concept/ design aspects of various ground improvement methods
CO3	Identify the construction procedure of different ground improvement methods
CO4	Choose different application of geosynthetics and soil stabilisation in Ground improvement

Mapping of course outcomes with program outcomes (Minimum requirement)

	PO1	PO2	PO3	PO4	PO5	PO6	PO7	PO8	PO9	PO10	PO11	PO12
CO1	2	-	-	-	-	-	-	-	-	-	-	-
CO2	2	-	-	-	-	-	-	-	-	-	-	-
CO3	3	2	-	-	-	-	-	-	-	-	-	-
CO4	3	2	-	-	-	-	-	-	-	-	-	-

Assessment Pattern

Bloom's Category	Continuous Assessment Tests		End Semester Examination
	1	2	
Remember	10		10
Understand	10	10	30

Apply	30	40	60
Analyse			
Evaluate			
Create			

Mark distribution

Total Marks	CIE	ESE	ESE Duration
150	50	100	3 hours

Continuous Internal Evaluation Pattern:

Attendance	: 10 marks
Continuous Assessment Test(2numbers)	: 25 marks
Assignment/Quiz/Course project	: 15marks

End Semester Examination Pattern: There will be two parts; Part A and Part B.

Part A contain 10 questions with 2 questions from each module having 3 marks for each question. Students should answer all questions.

Part B contains 2 questions from each Module of which student should answer any one question form each Module. Each question should have a maximum if two subdivision and carry 14marks.

Course Level Assessment Questions

CO1: Classify different ground improvement methods based on the soil suitability

1. Explain the relevance of Ground improvement techniques.
2. Summarize different method of in-situ ground improvement techniques and its applications.

CO2: Outline the basic concept/ design aspects of various ground improvement methods

1. Explain the basic concept used in blasting technique
2. Explain the design consideration of soil nailing

CO3: Identify the construction procedure of different ground improvement methods

1. Explain Grouting technique used for Ground Improvement.
2. Explain the installation procedure of PVD

CO4: Choose different application of geosynthetics and soil stabilisation in Ground improvement

1. Illustrate the application of geo-textile as (a) Filtration (b) Drainage (c) Erosion control.
2. Explain the chemical aspects of lime stabilization

Syllabus

MODULE 1.

Roll of ground improvement in foundation engineering- Classification of ground improvement methods-different problematic soil -selection of suitable ground improvement based on the soil condition-Emerging trends in ground improvement-Different materials used for ground improvement and its property

Brief introduction to sustainable method of ground improvement, Microbial methods

MODULE 2.

In situ Densification-Deep compaction and shallow compaction, Properties of compacted soil and compaction control.

Dynamic Compaction-Procedure-design considerations, soil suitability, Merit and demerit.

Vibration methods-Vibro compaction techniques-Blasting, Vibrating compactors

Vibro displacement methods-Vibro-flotation. Sand pile, Stone column, Lime pile-principle, installation procedure, basic design considerations, soil suitability, Merit and demerits

MODULE 3.

Drainage methods- Methods of dewatering systems-Open sump, Well points, Vacuum and electroosmotic methods

Drains-type-drainage facility after construction-Foundation drain, Blanket drain, Interceptor drains

Precompression and Vertical Drain – Preloading, Vertical drain-General principle, Soil suitability, Type-sand drain, PVD-Installation procedure

MODULE 4.

Earth Reinforcement-Reinforcement materials-reinforced earth wall-design considerations-construction procedure

Soil nailing & Micro pile-basic concept-construction sequence-areas of application-design considerations-merit and demerit

Geosynthetics - use, type-function- filtration, drainage, separation-Application of geotextile in different works

MODULE 5.

Grouting Techniques- Grouting material-groutability-stabilization with cement, lime and chemicals

Classification of grouting techniques-particulate grouting, Compaction grouting, penetration grouting, jet grouting, displacement grouting-Procedure-soil suitability-merit and demerit.

Thermal method-stabilization by heating, stabilization by cooling

Soil stabilization- Fundamental concept of soil-cement stabilisation, Mechanism of lime stabilisation

Text Books:

1. P. Purushothama Raj, Ground Improvement Techniques , Laxmi Publications (P) Ltd.
2. Manfred. R. Hausmann, Engineering Principles of Ground Modification, McGraw Hill, 1989

References:

1. M.P. Moseley and K. Kirsch (Edited), Ground improvement, Second edition, Spon Press, Taylor and Francis group

Course Contents and Lecture Schedule

Module	Topic	CO addressed	No. of Lectures
1	Module I: Total lecture hours:6		
1.1	Roll of ground improvement in foundation engineering-	1	1
1.2	Classification of ground improvement methods	1	1
1.3	Different problematic soil -selection of suitable ground improvement based on the soil condition-	1	1
1.4	Emerging trends in ground improvement	1	1
1.5	Different materials used for ground improvement and its property	1	1
1.6	Brief introduction to sustainable method of ground improvement, Microbial methods	1	1
2	Module II: Total lecture hours-8		

2.1	In situ Densification-Deep compaction and shallow compaction, Properties of compacted soil and compaction control.	2	1
2.2	Dynamic Compaction-Procedure-design considerations, soil suitability, Merit and demerit.	2	1
2.3	Vibration methods-Vibro compaction techniques-	3	1
2.4	Blasting, Vibrating compactors	3	1
2.5	Vibro displacement methods-Vibro-flotation.	3	1
2.6	Sand pile, Stone column, principle, installation procedure, basic design considerations, soil suitability, Merit and demerits	2,3	2
2.7	Lime pile-principle, installation procedure, basic design considerations, soil suitability, Merit and demerit	2,3	1
3	Module III: Total lecture hours: 7		
3.1	Drainage methods- Methods of dewatering systems-Open sump, Well points, Vacuum	2,3	1
3.2	Vacuum and electroosmotic methods	2,3	2
3.3	Drains-type-drainage facility after construction-Foundation drain, Blanket drain, Interceptor drains	2	1
3.4	Precompression and Vertical Drain – Preloading, General principle, Soil suitability	2,3	1
3.5	Vertical drain-General principle, Soil suitability, Type-sand drain, PVD-Installation procedure	2,3	2
4	Module IV: Total lecture hours: 7		
4.1	Earth Reinforcement-Reinforcement materials-reinforced earth wall, construction procedure	2,3	2

4.2	Soil nailing -basic concept-construction sequence-areas of application-design considerations-merit and demeri	3	1
4.3	Micro pile-basic concept-construction sequence-areas of application-design considerations-merit and demerit	2,3	1
4.4	Geosynthetics - use, type-function- filtration, drainage, separation-Application of geotextile in different works	4	3
5	Module V: Total lecture hours: 8		
5.1	Grouting Techniques- Grouting material-groutability-stabilization with cement, lime and chemicals	2,3	2
5.2	Classification of grouting techniques-particulate grouting, Compaction grouting, penetration grouting, jet grouting, displacement grouting-Procedure-soil suitability-merit and demerit.	2,3	3
5.3	Thermal method-stabilization by heating , stabilization by cooling	1,2	1
5.4	Soil stabilization- Fundamental concept of soil-cement stabilisation, Mechanism of lime stabilisation	4	2

Estd.



2014

Model Question Paper

Reg.No.: _____

Name: _____

APJ ABDUL KALAM TECHNOLOGICAL UNIVERSITY
SEVENTH SEMESTER B. TECH DEGREE EXAMINATION

Course Code: CET423

Course Name: GROUND IMPROVEMENT TECHNIQUES

Max.Marks:100

Duration: 3Hours

PART A

Answer all questions; each question carries 3 marks.

(10×3 marks = 30 marks)

1. Explain the importance of Ground improvement in foundation engineering.
2. Name any five-material used for ground improvement.
3. Explain the blasting method used for Ground improvement.
4. Write note on Column techniques for Ground improvement.
5. How Electro osmotic method is applied for Ground Improvement.
6. Write note on the importance of lowering the ground water in a construction site.
7. Outline the use of micro pile as ground improvement choice.
8. List different type of geosynthetics.
9. list the different type of grouting material used for ground improvement?
10. Explain method of stabilisation using cement.

PART B

Answer one full question from each module (14 × 5 = 70 Marks)

Module I

11. (a) Categories different ground improvement methods based on the soil suitability (7)
 (b) Explain the property of material suitable for ground improvement (7)
12. (a) List the different method of insitu ground improvement techniques and its applications (10)
 (b) Explain the properties of material used for ground improvement (4)

Module II

13. (a) Explain the Dynamic Compaction for Ground improvement. (10)
 (b) Explain about the compaction control (4)
14. (a) Outline how the ground improvement are achieved by vibration techniques. (7)
 (b) What is Stone column? Explain its method of construction (7)

Module III

15. (a) Explain the application of vertical drain. (7)
(b) What is PVD? Explain its advantage over other drains. (7)
16. (a) Illustrate the well point system of dewatering. (7)
(b) Explain about different drains facility (7)

Module IV

17. Illustrate the application of geo-textile as (a) Filtration (b) Drainage (c) Erosion control.
18. Explain the design considerations of a) Reinforced Earth wall (b) Soil nailing

Module V

19. (a) Explain Grouting technique used for Ground Improvement. (10)
(b) Explain the principle of ground freezing (4)
20. Describe the chemical aspects of lime stabilisation and its effects on adjacent soil.

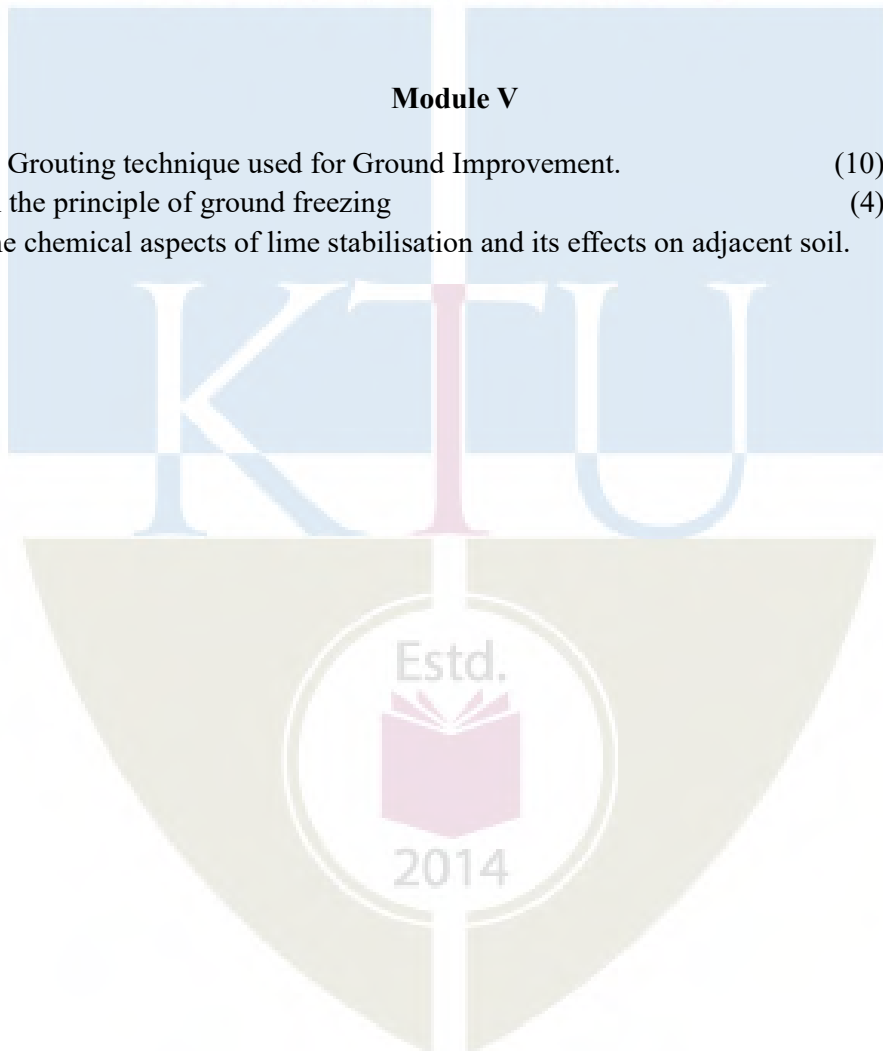

CET433	HIGHWAY MATERIALS AND DESIGN	CATEGORY	L	T	P	CREDIT	YEAR OF INTRODUCTION
		PEC	3	0	0	3	2019

Preamble The course aims to impart in-depth knowledge pertinent to characteristics of various highway materials, tests on highway materials, design of bituminous mixes, analysis and design of highway pavements etc.

Prerequisite: CET 206 GEO TECHNICAL ENGINEERING

Course Outcomes: After the completion of the course the students will be able to

CO 1	Identify suitable materials for different types of pavements (K2, K3)
CO 2	Interpret material test results with respect to field conditions and standards (K2, K3)
CO 3	Apply the pavement material properties to analysis of pavements (K2,K3)
CO 4	Evaluate material properties and design pavement mixes.(K3,K4)
CO 5	Analyse and design the pavement, flexible or rigid, for the conditions prevailing at site (K3, K4)

Mapping of course outcomes with program outcomes

	PO1	PO2	PO3	PO4	PO5	PO6	PO7	PO8	PO9	PO 10	PO 11	PO 12
CO 1	3											
CO 2	3		2			2						
CO 3	3	2		2								2
CO 4	3	3	3	2		2						2
CO 5	3	3	3	3		3						2

Assessment Pattern

Bloom's Category	Continuous Assessment		End Semester Examination (marks)
	Test 1 Marks	Test 2 Marks	
Remember	5	5	10
Understand	10	10	40

Apply	5	5	20
Analyse	5	5	30
Evaluate			
Create			

Mark Distribution

Total Marks	CIE (Marks)	ESE (Marks)	ESE Duration
150	50	100	3 hours

Continuous Internal Evaluation Pattern:

Attendance	: 10 marks
Continuous Assessment Test (2 numbers)	: 25 marks
Assignment/Quiz/Course Project	: 15 marks

End Semester Examination Pattern:

The question consists of two parts- Part A and Part B. Part A consists of 10 questions with 3marks for each (two questions from each module). Part B consists of two questions from each module, out of which one has to be answered. Each question carries 14 marks and can have maximum 2 subdivisions.

Sample Course Level Assessment Questions:**Course Outcome 1 (CO1)**

Identify the suitable materials for different types of pavement constructions?

Course Outcome 2 (CO2)

Assess the suitability of pavement materials with respect to field conditions of any site known to you.

Course Outcome 3 (CO3)

Explain the various properties of materials used in the analysis of pavements, why are they significant?

Course Outcome 4 (CO4)

- 1) What are the desirable properties of bituminous mixes?
- 2) Explain the steps involved in the bituminous mix design?
- 3) What are the techniques used?

Course Outcome 5 (CO5)

- 1) Design a flexible pavement for the conditions prevailing at a specific site(rural road through marshy land).
- 2) Analyse the various stresses developed in a rigid pavement, for the specified requirements?

Syllabus

Module 1	<p>Pavements and materials: Desirable properties and testing of road aggregates</p> <p>Introduction to highway pavements, Types and component parts of pavements, Factors affecting design and performance of pavements, Pavement Materials-Road aggregates, Tests on aggregates and specifications for flexible and rigid pavements, Principles and methods of Gradation for soil – Aggregate mixes. Alternate Materials for durable pavements -Artificial aggregates.</p>
Module 2	<p>Desirable properties and testing of bitumen</p> <p>Properties and tests on Bituminous binders –Methods of grading, Emulsions – Properties and tests, Cut backs and Modified binders-Types, characteristics and uses, aging of bitumen and aging tests.</p>
Module 3	<p>Testing of subgrade soil and pavement mixes</p> <p>Functions and significance of sub grade properties, Various methods of assessment of sub grade soil strength for pavement design. Testing of sub base, base course and interlayer materials.</p> <p>Mix design procedures in mechanical stabilisation of soils, Design of bituminous mixes by Marshall, Hubbard - field and Hveem's methods</p>
Module 4	<p>Design of flexible pavements</p> <p>Introduction to analysis and design of flexible pavements, Stresses and deflections in homogeneous masses, Burmister's 2 layer and 3 layer theories, Wheel load stresses, ESWL of multiple wheels, Repeated loads and EWL factors, Empirical, semi - empirical and theoretical approaches for flexible pavement design, Group index, CBR, Triaxial, Mcleod and Burmister layered system methods</p>
Module 5	<p>Design of rigid pavements</p> <p>Introduction to analysis and design of rigid pavements, Types of stresses and causes, Factors influencing stresses, General conditions in rigid pavement analysis, Warping stresses, Frictional stresses, Combined stresses</p> <p>Joints in cement concrete pavements, Joint spacings, Design of slab thickness, Design and detailing of longitudinal, contraction and expansion joints, IRC methods of Design</p>

Text Books:

1. Justo C.E.G , Veeraragavan A and Khanna S.K; Highway Engineering, Nem Chand Publishers, Revised 10th Ed, 2018.
2. Yoder E J and Witezak, M W Principles of Pavement Design, John Wiley and sons, 2nd Edition 2011.
3. Kadiyali L R: Highway Engineering, Khanna publication Revised Edition, 2017

References

1. Yang, H H Design of functional pavements, McGraw-Hill, 1973.
2. Atkins, H.N Highway Materials, Soils, and Concrete, Prentice Hall, 2002
3. Krebs, R.D. Highway Materials, McGraw Hill Text, 1971.
4. Relevant IRC codes
5. MoRTH specifications

Course Content and lecture Schedule:

No.	Topic	Course Outcome	No. of Hrs
1	Module 1		Total:6
1.1	Introduction to highway pavements, Types and component parts of pavements	CO1	1
1.2	Road aggregates, Tests and specifications on aggregates for flexible and rigid pavements	CO1	2
1.3	Principles and methods of Gradation for soil – Aggregate mixes	CO1	2
1.4	Alternate Materials for durable pavements: artificial aggregates		1
2	Module 2		Total: 6
2.1	Properties and tests on bitumen -Bituminous binders – Methods of grading,	CO2	2
2.2	Emulsions –Properties and tests, Cut backs and Modified binders-Types, characteristics and uses,	CO2	2
2.3	Aging of bitumen and aging tests		2
3	Module 3		Total: 8
3.1	Functions and significance of sub grade properties, Various methods of assessment of sub grade soil strength for pavement design	CO3	2
3.2	Soil stabilization -Mix design procedures in mechanical stabilization of soils,	CO4	3
3.3	Sub base, base course mixes and interlayers. Design of bituminous mixes by Marshall, Hubbard - field and Hveem's methods	CO4	3
4	Module 4		Total: 8
4.1	Introduction to analysis and design of flexible pavements, Stresses and deflections in homogeneous masses, Burmister's 2 layer and 3 layer theories,	CO5	2
4.2	Wheel load stresses, ESWL of multiple wheels, Repeated loads and EWL factors,	CO5	2
4.3	Empirical and semi - empirical approaches for flexible pavement design, Group index, CBR, Triaxial and Mcleod methods	CO5	2
4.4	Theoretical approaches for flexible pavement design-	CO5	2

	Burmister layered system methods of design		
5	Module 5		Total: 8
5.1	Introduction to analysis and design of rigid pavements, Types of stresses and causes, Factors influencing stresses, General conditions in rigid pavement analysis,	CO5	2
5.2	Warping stresses, Frictional stresses, Combined stresses	CO5	2
5.3	Joints in cement concrete pavements, Joint spacings, Design and detailing of longitudinal, contraction and expansion joints,	CO5	2
5.4	Design of slab thickness and IRC methods of Design	CO5	2



Model Question Paper

APJ ABDUL KALAM TECHNOLOGICAL UNIVERSITY
SEVENTH SEMESTER B. TECH DEGREE EXAMINATION, MONTH & YEAR
Course Code: CET 433
Course Name: HIGHWAY MATERIALS AND DESIGN

Max. Marks:100

Duration: 3 hrs

PART A**(Answer all Questions: Each question carries 3 marks)**

- 1 Differentiate between flexible and rigid pavements?
- 2 Explain the term Combined Flakiness and Elongation index?
- 3 What are the different methods of grading of bituminous binders?.
- 4 Explain the aging of bitumen?
- 5 What are the desirable properties of subgrade soil?.
- 6 What are the factors in design of mix for mechanical stabilization?
- 7 Mention the effects of repeated applications of loads on pavements?
- 8 Explain the concept of Equivalent single wheel load?
- 9 How the warping stresses in rigid pavements calculated?
- 10 The width of expansion joint gap is 2.5cm in a cement concrete pavement.If the laying temperature is 10°C and the maximum slab temperature in summer is 54°C, Calculate the spacing between expansion joints. coefficient of thermal expansion of concrete as 10×10^{-6} per°C.

(3 x 10=30 marks)

PART B**(Answer one full question from each module)****MODULE 1**

- 11 a. Explain the principles of various tests for judging the suitability of road aggregates? Specify the desirable values of the test results 14

OR

- 12 a. Explain the Principles and methods of Gradation for soil – Aggregate mixes 10
- b. Write short notes on the alternate Materials for durable pavements 4

MODULE 2

- 13 a. Explain the uses of emulsion and how are they prepared? 7
- b. List the different types of cutbacks and explain the various tests carried out on cutback bitumen? 7

OR

- 14 What are the various tests carried out on bitumen? Briefly mention the principles and uses of each test 14

MODULE 3

- 15 a. With the help of graphs, explain the procedure for the Marshall method of design of bituminous mixes? 8
- b. Explain the various methods to evaluate the soil strength for pavement design?. 6

OR

- 16 a. Explain the principles of soil stabilisation 4
- b. Explain the mix design procedures in mechanical soil stabilization 10

MODULE 4

- 17 a. State the advantages and disadvantages of group index method for design of flexible pavements. 6
- b. Explain the concept of CBR and give the step by step procedure for design of flexible pavements as per IRC recommendations. 8

OR

- 18 a. Illustrate the application of Burmister's 2 layer theory in pavement design? 6
- b. Estimate the thickness of sub base, base and wearing surface course of a flexible pavement system from following data, using Kansas triaxial test method. Moduli values of subgrade, sub base, base and wearing course are 100kg/cm^2 , 200kg/cm^2 , 400kg/cm^2 and 1000kg/cm^2 respectively. Given that radius of contact = 15cm, Design deflection = 0.25cm, assume saturation coefficient based on rainfall as 0.5 and traffic coefficient as 2. Wheel load = 4080kg. 8

MODULE 5

- 19 a. Calculate the stresses at interior, edge and corner regions of a C.C. pavement using Westergaard's stress equation for the following data: 7

Wheel load=5100 kg, Modulus of elasticity of concrete= $3 \times 10^5 \text{ kg/cm}^2$, poisson's ratio=0.15, pavement thickness=24cm, modulus of subgrade reaction = 6 kg/cm^3 , radius of contact area=15cm

- b. Define 1) Modulus of Subgrade reaction 2) Radius of relative stiffness 3) Equivalent radius of resisting section 7

OR

- 20 a. Estimate the thickness of cement concrete pavement using the method suggested by Indian Roads Congress 14

Modulus of elasticity of concrete $-3 \times 10^5 \text{ kg/cm}^2$

Modulus of rupture of concrete -40 kg/cm^2

Poissons ratio of concrete -0.15

Modulus of subgrade reaction -6 kg/cm^2

Wheel load $=5100\text{kg}$

Radius of contact area $=15\text{cm}$

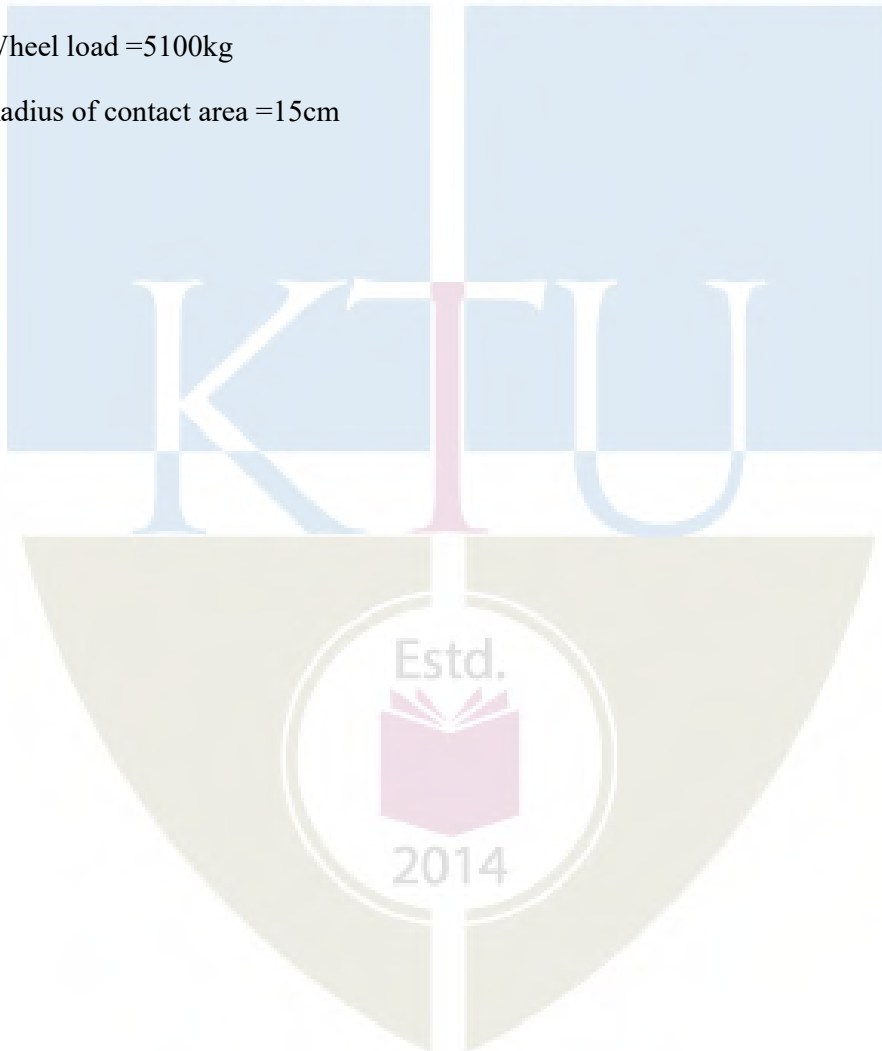

CET443	APPLIED HYDROLOGY	CATEGORY	L	T	P	CREDIT	YEAR OF INTRODUCTION
		PEC	3	0	0	3	2019

Preamble: The general objective of this course is to expose the students to the advanced concepts of hydrology and hydrologic systems. The course aim to impart the knowledge on the availability of water on hydrosphere, scientific methods quantifying the components of hydrologic cycle, statistical analysis of hydrologic datasets etc

Pre-requisite: CET307 HYDROLOGY AND WATER RESOURCES ENGINEERING

Course outcome: After the course, the student will be able to:

CO1	Describe or estimate the different components of hydrologic cycle
CO2	Explain the behavior of catchments and quantify the response of the catchment
CO3	Apply the concept of hydrograph for runoff computation
CO4	Apply hydrological and statistical principles for estimation of flood discharge
CO5	Determine the aquifer parameters and assess the groundwater quality

CO - PO Mapping

CET443 Applied Hydrology		PO1	PO2	PO3	PO4	PO5	PO6	PO7	PO8	PO9	PO10	PO11	PO12
	CO1	3	3										
	CO2	3	3										
	CO3	3	3										
	CO4	3	3										
	CO5	3	3										

Assessment pattern

Bloom's Category	Continuous Assessment Tests		End Semester Examination (Marks)
	Test 1 (Marks)	Test 2 (Marks)	
Remember	5	5	15
Understand	10	10	15
Apply	20	20	40
Analyze	15	15	30
Evaluate			
Create			

Continuous Internal Evaluation Pattern:

Attendance	: 10 Marks
Continuous Assessment Test (2 numbers)	: 25 Marks
Assignment/Quiz/Course project	: 15 Marks
Total	: 50 Marks

End semester examination pattern – There will be two parts; Part A and Part B. Part A contain 10 questions with 2 questions from each module, having 3 Marks for each question. Students should answer all questions. Part B contains 2 questions from each module of which student should answer any one. Each question can have maximum 2 sub-divisions and carry 14 Marks.

Course Level Assessment Questions

Qn No	Question	Marks	Course outcome (CO) Assessed
Part A (Answer ALL Questions)			
1	Explain probable maximum precipitation	3	CO1
2	Explain Green Ampt model for estimation of infiltration	3	CO1
3	What are the factors to be considered in selection of site for a stream gauging station ?	3	CO2
4	Explain the concept of stream ordering	3	CO2
5	Explain linear reservoir model	3	CO3
6	State the limitations of rational method of runoff computation	3	CO1, CO2
7	Differentiate hydrologic routing and hydraulic routing	3	CO4
8	Explain different methods of flood control	3	CO4
9	Explain Electrical resistivity method	3	CO5
10	Explain Method of images	3	CO5
Part B (Answer ANY ONE FULL question from each module)			
Module I			
11 (a)	What are IDF curves ? Explain its practical use	5	CO1
11 (b)	Estimate the PET of an area for the season November to February in which wheat is grown. The area is in North India at a latitude of 30 ⁰ N with mean monthly temperatures and %	9	CO1

	<p>daytime hours as below:</p> <table border="1"> <thead> <tr> <th>Month</th> <th>November</th> <th>December</th> <th>January</th> <th>February</th> </tr> </thead> <tbody> <tr> <td>Monthly day time hours</td> <td>7.19</td> <td>7.15</td> <td>7.30</td> <td>7.03</td> </tr> <tr> <td></td> <td>16.5</td> <td>13</td> <td>11</td> <td>14.5</td> </tr> </tbody> </table>	Month	November	December	January	February	Monthly day time hours	7.19	7.15	7.30	7.03		16.5	13	11	14.5																																																		
Month	November	December	January	February																																																														
Monthly day time hours	7.19	7.15	7.30	7.03																																																														
	16.5	13	11	14.5																																																														
12 (a)	<p>Explain Penmann-Montieth method of evapotranspiration estimation</p>	3	CO1																																																															
12 (b)	<p>The annual rainfall data of a station A and the annual rainfall values of 6 neighboring stations are given below. Check the consistency of rainfall record of station A, by double mass curve method</p> <table border="1"> <thead> <tr> <th>Year</th> <th>Annual rainfall of Station A (cm)</th> <th>6 station average (cm)</th> </tr> </thead> <tbody> <tr><td>1969</td><td>177</td><td>143</td></tr> <tr><td>1970</td><td>144</td><td>132</td></tr> <tr><td>1971</td><td>178</td><td>146</td></tr> <tr><td>1972</td><td>162</td><td>147</td></tr> <tr><td>1973</td><td>194</td><td>161</td></tr> <tr><td>1974</td><td>168</td><td>155</td></tr> <tr><td>1975</td><td>196</td><td>152</td></tr> <tr><td>1976</td><td>144</td><td>117</td></tr> <tr><td>1977</td><td>160</td><td>128</td></tr> <tr><td>1978</td><td>196</td><td>193</td></tr> <tr><td>1979</td><td>141</td><td>156</td></tr> <tr><td>1980</td><td>158</td><td>164</td></tr> <tr><td>1981</td><td>145</td><td>155</td></tr> <tr><td>1982</td><td>132</td><td>143</td></tr> <tr><td>1983</td><td>95</td><td>115</td></tr> <tr><td>1984</td><td>148</td><td>135</td></tr> <tr><td>1985</td><td>142</td><td>163</td></tr> <tr><td>1986</td><td>140</td><td>135</td></tr> <tr><td>1987</td><td>130</td><td>143</td></tr> <tr><td>1988</td><td>137</td><td>130</td></tr> </tbody> </table>	Year	Annual rainfall of Station A (cm)	6 station average (cm)	1969	177	143	1970	144	132	1971	178	146	1972	162	147	1973	194	161	1974	168	155	1975	196	152	1976	144	117	1977	160	128	1978	196	193	1979	141	156	1980	158	164	1981	145	155	1982	132	143	1983	95	115	1984	148	135	1985	142	163	1986	140	135	1987	130	143	1988	137	130	11	CO1
Year	Annual rainfall of Station A (cm)	6 station average (cm)																																																																
1969	177	143																																																																
1970	144	132																																																																
1971	178	146																																																																
1972	162	147																																																																
1973	194	161																																																																
1974	168	155																																																																
1975	196	152																																																																
1976	144	117																																																																
1977	160	128																																																																
1978	196	193																																																																
1979	141	156																																																																
1980	158	164																																																																
1981	145	155																																																																
1982	132	143																																																																
1983	95	115																																																																
1984	148	135																																																																
1985	142	163																																																																
1986	140	135																																																																
1987	130	143																																																																
1988	137	130																																																																

	1989	130	146																																		
	1990	163	161																																		
Module II																																					
13 (a)	Explain area-velocity method of stream gauging				4	CO2																															
13 (b)	Three points on a rating curve of a stream gauging station obtained from an eye-fit for the stage discharge data have the following coordinates : (100 m ³ /s; 121.67 m) (200 m ³ /s,122.23 m) and (400 m ³ /s,123.04). Determine the equation of the rating curve and compute the discharge in the stream corresponding to a stage of 124.5 m				10	CO2																															
14 (a)	Define (i) form factor (ii) Compactness coefficient (iii) drainage density (iv) time of concentration				8	CO2																															
14 (b)	Explain the method of extrapolation of stage discharge curve				6	CO2																															
Module III																																					
15 (a)	What are instantaneous Unit hydrographs ? Explain Nash's conceptual model				5	CO3																															
15 (b)	The effective rainfall hyetograph of a complex storm has duration of 12 h with rainfall intensity 2, 0.75 and 4 cm/h respectively in successive 4 h periods. The ordinates of the corresponding DRH read at 4 h intervals are 160, 300, 570, 636, 404, 234, 105 and 48 m ³ /sec. Determine the ordinates of 4 hr unit hydrograph using the deconvolution method				9	CO3																															
16	From the topographical map of a drainage basin, the following quantities are measured. A=3480 km ² ; Length of the main stream (L) is 148 km and distance from the centroid of the basin to the catchment outlet (Lc) is 74 km. The 12 hr unit hydrograph derived for the basin has a peak ordinate of 155 m ³ /s occurring at 40 hrs. Derive the 4 hr synthetic unit hydrograph of sub- basin of the catchment, having drainage area 2500 km ² , L=100km and Lc=50 km using Snyder's method				14	CO3																															
17 (a)	Data of monthly rainfall and runoff available for a basin are shown in Table. Develop a linear regression model between rainfall (P) and runoff (Q) and plot the relation.				8	CO3																															
	<table border="1" style="width: 100%; border-collapse: collapse;"> <thead> <tr> <th>Month</th> <th>1</th> <th>2</th> <th>3</th> <th>4</th> <th>5</th> <th>6</th> <th>7</th> <th>8</th> <th>9</th> </tr> </thead> <tbody> <tr> <td>P(cm)</td> <td>4</td> <td>40</td> <td>30</td> <td>25</td> <td>20</td> <td>15</td> <td>10</td> <td>5</td> <td>50</td> </tr> <tr> <td>Q (cm)</td> <td>0.2</td> <td>9</td> <td>5</td> <td>4.5</td> <td>2.5</td> <td>2</td> <td>1</td> <td>0.5</td> <td>14</td> </tr> </tbody> </table>					Month	1	2	3	4	5	6	7	8	9	P(cm)	4	40	30	25	20	15	10	5	50	Q (cm)	0.2	9	5	4.5	2.5	2	1	0.5	14		
Month	1	2	3	4	5	6	7	8	9																												
P(cm)	4	40	30	25	20	15	10	5	50																												
Q (cm)	0.2	9	5	4.5	2.5	2	1	0.5	14																												
17 (b)	Explain the deconvolution method of derivation of unit hydrograph from complex storms				6	CO3																															
Module IV																																					
18 (a)	Flood frequency computations for a river by using Gumbel's method, yielded the following results:				7	CO4																															

	<table border="1"> <thead> <tr> <th>Return period (T)(Years)</th> <th>Peak flood (m³/sec)</th> </tr> </thead> <tbody> <tr> <td>40</td> <td>27000</td> </tr> <tr> <td>80</td> <td>31000</td> </tr> </tbody> </table> <p>Estimate the flood magnitude in the river with the return period of 240 years.</p>	Return period (T)(Years)	Peak flood (m ³ /sec)	40	27000	80	31000																												
Return period (T)(Years)	Peak flood (m ³ /sec)																																		
40	27000																																		
80	31000																																		
18 (b)	Explain how you will you determine the Muskingum parameters	7	CO4																																
19 (a)	Route the flood hydrograph given below through a channel reach and derive the outflow hydrograph. The values of Muskingum parameters K and x are 12 h and 0.278 respectively	10	CO4																																
	<table border="1"> <thead> <tr> <th>Time(h)</th> <th>0</th> <th>4</th> <th>8</th> <th>12</th> <th>16</th> <th>20</th> <th>24</th> <th>28</th> <th>32</th> <th>36</th> <th>40</th> <th>44</th> <th>48</th> <th>52</th> <th>56</th> </tr> </thead> <tbody> <tr> <td>Flow (m³ s)</td> <td>42</td> <td>68</td> <td>116</td> <td>164</td> <td>194</td> <td>200</td> <td>192</td> <td>170</td> <td>150</td> <td>128</td> <td>106</td> <td>88</td> <td>74</td> <td>62</td> <td>54</td> </tr> </tbody> </table>	Time(h)	0	4	8	12	16	20	24	28	32	36	40	44	48	52	56	Flow (m ³ s)	42	68	116	164	194	200	192	170	150	128	106	88	74	62	54		
Time(h)	0	4	8	12	16	20	24	28	32	36	40	44	48	52	56																				
Flow (m ³ s)	42	68	116	164	194	200	192	170	150	128	106	88	74	62	54																				
19 (b)	Explain Flood routing and its importance	4	CO4																																
Module V																																			
20 (a)	Derive partial differential equation for unsteady flow in a confined aquifer	10	CO5																																
20 (b)	Explain method of images	4	CO5																																
21 (a)	Explain the methods of artificial recharge of groundwater	7	CO5																																
21 (b)	Explain the methods of control of seawater intrusion	7	CO5																																
22 (a)	Derive Ghyben-Herzberg relationship	6	CO5																																
22 (b)	In an artesian aquifer, the drawdown is 1.2 m at a radial distance of 10 m from a well after two hours of pumping. On the basis of Thies' non- equilibrium equation determine the pumping time for the same drawdown at a radial distance of 30 m from the well	8	CO5																																

Syllabus

Module I (7 Hours)

Hydrology and Hydrologic cycle -Test for consistency of rainfall records – Double mass curve method. Analysis of rainfall data – intensity, duration, frequency (IDF) curves; depth area duration (DAD) curve. Frequency analysis-probable maximum precipitation, Hydrologic abstractions- Infiltration- Green Ampt method, Evapotranspiration- methods of estimation- Blaney Criddle method (problem)- penman method, Penmann-Montieth method

Module II (7 hours)

Catchment characteristics, classification of streams - stream pattern and stream order; Stream gauging – methods- rating of current meter; Extension of stage discharge curve, Adjustment of stage discharge curve; selection of site for stream gauging stations.

Module III (7 Hours)

Runoff - Computation of runoff– Hydrograph analysis- S-hydrograph, unit hydrograph from complex storm, synthetic unit hydrograph, Instantaneous unit hydrograph (Brief description only) , linear reservoir model. Application of linear regression in hydrologic modeling

Module IV (7 Hours)

Design flood and their Estimation - Different methods; Flood frequency studies -Gumbel's method; Flood routing-Hydrologic and Hydraulic routing, Flood routing through reservoirs – concept only. Flood routing through channels - Muskingum method, determination of Muskingum parameters. Flood control methods - Flood forecasting and warning (Brief descriptions only)

Module V (7 Hours)

Partial differential equation governing unsteady groundwater flow- Evaluation of aquifer parameters - Theis method -Jacob's approximation method. Well flow near aquifer boundaries - Method of images, Surface investigation of groundwater - Electrical resistivity method. Graphical representation of hydrochemical data, Pollution of groundwater- sources; Seawater intrusion- Ghyben-Herzberg relationship, Method of control of seawater intrusion; Artificial recharge of groundwater.

Text Books:

1. Raghunath H.M. Hydrology: Principles, Analysis and Design. New Age International New Delhi 2006.
2. VenTe Chow. Hand book of Applied Hydrology, Tata McGraw Hill, 1988
3. Subramanya K. Engineering Hydrology, Tata McGraw Hill, 2013.
4. Reddy JR, A text book of Hydrology, Laxmi Publishers

References:

1. Ojha, C.S.P, R. Berndtsson, P.Bhunya, Engineering Hydrology, Oxford University Press
2. Todd D. K. Ground Water Hydrology, Wiley, 2005.
3. H.M Raghunath. Groundwater. New Age International New Delhi 2007
4. Garg S. K. Hydrology and Water Resources Engineering, Khanna Publishers New Delhi 2005.

5. Punmia B.C. Ashok K Jain, Arun K Jain, B. B. L Pande, Irrigation and Water Power Engineering, Laxmi Publications (P) Ltd. 2009

Course Contents and Lecture Schedule

Module	Topic	COs Mapped	Hours
Module I			
1	Hydrology and Hydrologic cycles	CO1	1
2	Test for consistency of rainfall data – Double Mass Curve	CO1	1
3	Analysis of rainfall data intensity, duration, frequency (IDF) curves	CO1	1
4	Depth area duration (DAD) curve. Frequency analysis- probable maximum precipitation	CO1	1
5	Hydrologic abstractions- Infiltration- Green Ampt method	CO1	1
6	Evapotranspiration- methods of estimation- Blaney Criddle method	CO1	1
7	Penman method, Penmann-Montieth method	CO1	1
Module II			
8	Catchment Characteristics	CO2	1
9	Classification of streams – Stream pattern and stream order.	CO2	1
10	Stream gauging- different methods	CO2	1
11	Selection of site for stream gauging stations	CO2	1
12	Stage Discharge Curve	CO2	1
13	Extension of stage discharge curve	CO2	1
14	Adjustment of stage discharge curve	CO2	1
Module III			
15	Runoff - Computation of runoff	CO1,CO2	1
16	Hydrograph analysis and S- Hydrograph	CO3	2
17	Unit hydrograph from complex storm	CO3	1
18	Synthetic unit hydrograph	CO3	1
19	Instantaneous unit hydrograph, Linear reservoir model	CO3	1
20	Application of linear regression in hydrologic modeling	CO1, CO3	1
Module IV			
21	Design flood and their Estimation - Different methods	CO4	1
22	Flood frequency studies -Gumbel's method	CO4	1
23	Flood routing-Hydrologic and Hydraulic routing	CO4	1
24	Flood routing through reservoirs – concept and approaches	CO4	1
25	Flood routing through channels - Muskingum method	CO4	2
26	Flood control methods , Flood forecasting and warning	CO1, CO4	1
Module V			
27	Partial differential equation governing unsteady groundwater flow; Evaluation of aquifer parameters - Theis method	CO5	1

28	Jacob's approximation method	CO5	1
29	Well flow near aquifer boundaries - Method of images	CO5	1
30	Surface investigation of groundwater - Electrical resistivity method.	CO5	1
31	Graphical representation of hydrochemical data, Pollution of groundwater- sources;	CO5	1
32	Seawater intrusion- Ghyben-Herzberg relationship, Method of control of seawater intrusion; Artificial recharge of groundwater.	CO5	2



Model Question Paper

Reg No.:.....

Name:.....

**APJ ABDUL KALAM TECHNOLOGICAL UNIVERSITY
SEVENTH SEMESTER B.TECH DEGREE EXAMINATION, MONTH & YEAR**

Course Code: CET443

Course Name: APPLIED HYDROLOGY

Max. Marks: 100

Duration: 3 hours

PART A**(Answer all questions; each question carries 3 Marks)**

- 1 Explain Probable maximum precipitation
- 2 Explain Green Ampt model for estimation of infiltration
- 3 What are the factors to be considered in selection of site for a stream gauging station ?
- 4 Explain the concept of stream ordering
- 5 Explain S-hydrograph and its use
- 6 State the limitations of rational method of runoff computation
- 7 Differentiate hydrologic routing and hydraulic routing
- 8 Explain different methods of flood control
- 9 Explain Electrical resistivity method for subsurface investigations
- 10 Explain Method of images 10*3=30

PART B**(Answer one full question from each module, each question carries 14 Marks)****Module I**

- 11 a. What are the causes of inconsistency of rainfall records? Explain double mass curve method for checking the consistency of rainfall records (5 Marks)
- b. Determine the yearly consumptive use of water for sugarcane for the following data by Blaney-criddle method (9 Marks)

Month	Monthly mean Temperature (°C)	Monthly Crop coefficient k	Percent sunshine hours, P
January	13.1	19.05	7.38

February	15.7	20.32	7.02
March	20.7	21.59	8.39
April	27.0	21.59	8.69
May	31.1	22.86	9.48
June	33.0	24.13	9.41
July	30.6	25.40	9.60
August	29.0	25.40	9.60
September	28.2	24.13	8.33
October	24.7	22.86	8.01
November	18.8	21.59	7.25
December	13.7	19.05	7.06

OR

- 12 a. Explain any three methods for determination of evapotranspiration (9 Marks)
- b. What are IDF curves ? Explain its practical use? (5 Marks)

Module II

- 13 a. Define (i) compactness coefficient (ii) Ordering of streams (iii) stream patterns (7 Marks)
- b. Three points on a rating curve of a stream gauging station obtained from an eye-fit for the stage discharge data have the following coordinates : (100 m³/s; 121.67 m) (200 m³/s,122.23 m) and (400 m³/s,123.04). Determine the equation of the rating curve and compute the discharge in the stream corresponding to a stage of 124.5 m (7 Marks)

OR

- 14 a. Explain current meter rating curve and its use. How it is different from stage discharge curve ? (10 Marks)
- b. Explain the classification of streams (4 Marks)

Module III

- 15 a. What are instantaneous Unit hydrographs ? Explain Nash's conceptual model (5 Marks)
- b. The effective rainfall hyetograph of a complex storm has duration of 12 h with rainfall intensity 2, 0.75 and 4 cm/h respectively in successive 4 h periods. The ordinates of the corresponding DRH read at 4 h intervals are 160, 300, 570, 636, 404, 234, 105 and 48 m³/sec. Determine the ordinates of 4 hr unit hydrograph using the deconvolution method (9 Marks)

OR

- 16 . From the topographical map of a drainage basin, the following quantities are (14 Marks)

measured. $A=3480 \text{ km}^2$; Length of the main stream (L) is 148 km and distance from the centroid of the basin to the catchment outlet (L_c) is 74 km. The 12 hr unit hydrograph derived for the basin has a peak ordinate of $155 \text{ m}^3/\text{s}$ occurring at 40 hrs. Derive the 4 hr synthetic unit hydrograph of sub-basin of the catchment, having drainage area 2500 km^2 , $L=100\text{km}$ and $L_c=50 \text{ km}$ using Snyder's method

(10 Marks)

Module IV

- 17 a. Explain any two empirical methods for computation of flood discharge. (4 Marks)
 b. Flood frequency computations for a river by using Gumbel's method, yielded the following results: (10 Marks)

Return period T (years)	Peak flood (m^3/s)
50	40,809
100	46,300

Estimate the flood magnitude in the river with the return period of 500 years.

OR

- 18 a. Explain flood warning and its importance (4 Marks)
 b. Route the flood hydrograph given below through a channel reach and derive the outflow hydrograph. The values of Muskingum parameters K and x are 12 h and 0.278 respectively (10 Marks)

Time(h)	0	4	8	12	16	20	24	28	32	36	40	44	48	52	56
Flow (m^3/s)	42	68	116	164	194	200	192	170	150	128	106	88	74	62	54

Module V

- 19 a. Derive Ghyben-Herzberg relationship (6 Marks)
 b. In an artesian aquifer, the drawdown is 1.2 m at a radial distance of 10 m from a well after two hours of pumping. On the basis of Thies' non-equilibrium equation determine the pumping time for the same drawdown at a radial distance of 30 m from the well (8Marks)

OR

- 20 a. Derive partial differential equation for unsteady flow in a confined aquifer (8 Marks)
 b. Explain the methods of artificial recharge of groundwater (6 Marks)

CET453	CONSTRUCTION PLANNING AND MANAGEMENT	CATEGORY	L	T	P	CREDIT	YEAR OF INTRODUCTION
		PEC	3	0	0	3	2019

Preamble: Construction Planning and Management is an elective course designed to provide in-depth knowledge in the planning and management of construction projects. The course details various operations encountered in a construction project in different phases throughout the lifecycle of a project, from planning, design, construction and operations. The course also helps students to develop the required skills to plan and manage various types of construction projects effectively and efficiently using the latest technologies like BIM.

Prerequisite: CET 309 Construction Technology and Management

Course Outcomes: After the completion of this course the student will be able to

Course Outcome	Description of Course Outcome	Prescribed learning level
CO1	Apply knowledge of Planning and Management for planning and execution of Construction Projects	Applying
CO2	Explain techniques for Project Planning, Scheduling, Construction Administration and Management	Understanding
CO3	Identify the criteria for selecting the appropriate method and tools as per the requirement of each project or site.	Understanding
CO4	Discuss the latest industry standards and technologies used in construction projects for planning and management.	Understanding
CO5	Explain the financial and legal aspects involved in a construction project.	Understanding

Mapping of course outcomes with program outcomes (Minimum requirement)

	PO1	PO2	PO3	PO4	PO5	PO6	PO7	PO8	PO9	PO10	PO11	PO12
CO1	2				2				2		3	2
CO2	2	2		2			1		2		3	2
CO3	2	2	2		2	2	1		2	1	3	2
CO4	2	1		1	1	2	1		2	3	3	2
CO5	2	2	2	1	2		1	3	2		3	2

Assessment Pattern

Bloom's Category	Continuous Assessment Tests		End Semester Examination
	1	2	
Remember	10	10	10
Understand	30	30	70
Apply	10	10	20
Evaluate			
Analyse			
Create			

Mark distribution

Total Marks	CIE	ESE	ESE Duration
150	50	100	3 hours

Continuous Internal Evaluation Pattern:

Attendance : 10 marks
 Continuous Assessment Test (2 numbers) : 25 marks
 Assignment/Quiz/Course project :15 marks

End Semester Examination Pattern: There will be two parts; Part A and Part B. Part A contain 10 questions with 2 questions from each module, having 3 marks for each question. Students should answer all questions. Part B contains 2 questions from each module of which student should answer any one. Each question carries 14 marks and can have maximum 2 sub-divisions.

Course Level Assessment (Sample) Questions**CO1: Apply knowledge of Planning and Management for planning and execution of Construction Projects**

1. How do you structure a team for a project? What do you consider?
2. What are the functions of construction management and give its applications?
3. What actions would you take if a project is falling behind schedule or exceeding the project's budget?
4. What would you do if some of your workers were not using the necessary safety equipment?

CO2: Explain techniques for Project Planning, Scheduling , Construction Administration and Management

1. List out the various network techniques in construction management.
2. Name the resource allocation methods and give the steps involved in any one

of the resource allocation methods.

3. Explain the different costs involved in material management for material, labour and expenses.

CO3: Identify the criteria for selecting the appropriate method and tools as per the requirement of each project or site.

1. What methods do you use to monitor and track the progress of your construction project?
2. Elucidate the methods to prioritize the necessary tasks for a project.
3. How do you know when a construction project is well-executed and what do you look for in quality control?

CO4: Discuss the latest industry standards and technologies used in construction projects for planning and management.

1. What are some of the major uses of BIM?
2. What is the difference between Retained Logic & Override Logic in progress update?
3. What is Clash Detection? How does it help in Construction Projects?

CO5: Explain the financial and legal aspects involved in a construction project.

1. What factors would you consider before negotiating contracts or rates?
2. Explain the different laws relating to wages.
3. Explain legal and financial aspects of accidents in construction projects.



Syllabus

Module 1

Introduction: Objectives of construction planning and management. Importance of Management in Construction, Construction team- Roles, responsibilities and skills.

Organisation and Hierarchy in Construction Projects – Types, Characteristics, Functions and Flow charts.

Construction scheduling: Review of CPM and PERT (AoN network), Time-cost trade-off – Cost optimization through the crashing of a network, Resource smoothing and resources levelling – concept only.

Module 2

Introduction to BIM Technology: Define BIM and BIM model, Describe workflow in using BIM in the building lifecycle, Model-Based cost estimating, Perform Simulations, Apply BIM to reduce error and change orders in projects, Evaluate and communicate ideas related to the use of BIM in the building life cycle, BIM Benefits: Case Studies, Organizational Maturity and Dimensions, Construction Management and Planning using BIM

Labour Legislations pertaining to the construction industry, Payment of Wages Act, Minimum Wages Act, Contract Labour Act, Labour Welfare Fund Act, Workmen's Compensation Act.

Module 3

Human Resource Management: manpower estimation at various stages, recruitment, training, under and overmanning.

Materials Management: Materials of construction, classification codification, ABC analysis, estimation of materials procurement, inventory/stock control, Economic Order Quantity, purchase procedure, stores management

Quality control in Construction: Importance of quality, elements of quality, organization for quality control, quality assurance technique.

Construction Safety Management: Important causes of accidents on construction sites, safety measures, safety benefits to employees, employees and customers.

Module 4

Economics of Project Management: Economic analysis of projects – NPV, Rate of return analysis, cost-benefit analysis.

Tendering – E Tendering / Electronic Process.

Contract – Contract documents and conditions of Contract, Contract agreement

Technical terms only - Administrative approval, Technical Sanction, Secured Advance, Mobilization Advance, Heads of accounts in government organization, Earnest money deposit (EMD) and Security deposit (SD). Accounting- Terms only- Work Abstract, Cash book, Work register, Accounting for the materials, Measurement book, Muster roll and Record of Bills

Module 5

Budgetary Control Systems: Types of budgets, new approaches for budgeting, responsibility of accounting, profit centre approach.

Financial Management: Meaning and scope, financial statement analysis, financial ratio analysis, funds flow analysis.

Working Capital Management: Meaning, policy for working capital, estimating working capital needs. Capital investment decision, long term financing working of financial institutions in India and abroad, self-financing, financing mechanisms.

Text Books:

1. Srinath, L.S. PERT and CPM Principles and Applications, 3rd ed. Affiliated East-West Press, New Delhi 2015.
2. Kumar Neeraj Jha, Construction Project Management, 2nd ed Pearson, Dorling Kindersley (India) pvt. Ltd 2015
3. K. K. Chitkara, Construction Project Management Planning Scheduling & Controlling, Tata McGraw Hill, New Delhi 2014.

References:

1. Gupta, B.L. and Gupta, Amit. Construction Management, Machinery and Accounts, 3rd ed. Standard Pub, 2005.
2. Loraine, R.K. Construction Management in Developing Countries. Thomas Telford, London, 1993.
3. Singh, Harpal. Construction Management and Accounts 14th ed. Tata McGraw-Hill Pub., New Delhi, 1981.
4. Gould, E. Frederick and Joyce, E. Nancy. Construction Project Management. Prentice Hall, New Jersey, 2000.
5. Shrivastava, U.K. Construction Planning and Management, 3rd ed. Galgotia Pub., New Delhi, 2004
6. Brad Hardin, Dave McCool . BIM and Construction Management: Proven Tools, Methods, and Workflows Paperback – 2017 .

Course Contents and Lecture Schedule

Module	Topic Course	Course Outcomes Addressed	No. of Lectures
1	Module I : Total lecture hours : 7		
1.1	Introduction: Objectives of construction planning and management. Importance of Management in Construction, Construction team- Roles, responsibilities and skills.	CO2	1
1.2	Organisation and Hierarchy in Construction Projects -Types, Characteristics, Functions and Flow charts.	CO1, CO2	2
1.3	Review of CPM and PERT, Time-cost trade-off – Cost optimization through the crashing of a network, Resource smoothing and resources levelling – concept only.	CO1, CO2	4
2	Module II: Total lecture hours: 7		
2.1	Introduction to BIM Technology: Define BIM and BIM model, Describe workflow in using BIM in the building lifecycle, Model-Based cost estimating, Apply BIM to reduce error and change orders in projects	CO2, CO3, CO4	3
2.2	Evaluate and communicate ideas related to the use of BIM in the building life cycle, BIM Benefits: Case Studies, Organizational Maturity and Dimensions, Construction Management and Planning using BIM	CO1, CO3, CO4	2
2.3	Labour Legislations pertaining to the construction industry, Payment of Wages Act, Minimum Wages Act, Contract Labour Act, Labour Welfare Fund Act, Workmen's Compensation Act.	CO2, CO5	2
3	Module III: Total lecture hours: 6		
3.1	Human Resource Management: manpower estimation at various stages, recruitment, training, under and overmanning.	CO1	1
3.2	Materials Management: Materials of construction, classification codification, ABC analysis, Estimation of materials procurement, inventory/stock control, Economic Order Quantity, purchase procedure, stores management.	CO1	2
3.3	Quality control in Construction: Importance of quality, elements of quality, organization for quality control, quality assurance technique.	CO1	1
3.4	Construction Safety Management: Important causes of accidents, safety measures, safety benefits to employees, employees and customers.	CO2	2
4	Module IV: Total lecture hours: 7		
4.1	Economics of Project Management: Economic analysis of projects, – NPV, Rate of return analysis, cost-benefit	CO2, CO4	2

	analysis.		
4.2	Tendering – E Tendering / Electronic Process.	CO2, CO4	1
4.3	Contract – Contract documents and conditions of Contract, Contract agreement	CO2	2
4.4	Technical terms only - Administrative approval, Technical Sanction, Secured Advance, Mobilization Advance, Heads of accounts in government organization, Earnest money deposit (EMD) and Security deposit (SD). Accounting- Terms only- Work Abstract, Cash book, Work register, Accounting for the materials, Measurement book, Muster roll and Record of Bills	CO2	2
5	Module V: Total lecture hours: 8		
5.1	Budgetary Control Systems: Types of budgets, new approaches for budgeting, responsibility of accounting, profit centre approach.	CO2, CO5	2
5.2	Financial Management: Meaning and scope, financial statement analysis, financial ratio analysis, fund flow analysis.	CO2, CO5	2
5.3	Working Capital Management: Meaning, policy for working capital, estimating working capital needs. Capital investment decision	CO2, CO5	2
5.4	Long term financing working of financial institutions in India and abroad, self-financing, financing mechanisms.	CO2, CO5	2

Estd.



2014

Model Question Paper**APJ ABDUL KALAM TECHNOLOGICAL UNIVERSITY
SEVENTH SEMESTER B. TECH DEGREE EXAMINATION, MONTH & YEAR****Course Code: CET453****Course Name: CONSTRUCTION PLANNING AND MANAGEMENT**

Marks : 100

Duration : 3 hrs

PART A**(Answer all Questions. Each Question carries 3 Marks)**

1. Differentiate between resource smoothing and resource levelling.
2. List out members of the construction team and write the responsibilities.
3. Explain BIM Technology.
4. What is meant by Organizational Maturity of BIM?
5. Explain Economic Order Quantity.
6. List the important causes of accidents on construction sites.
7. Explain rate of return analysis.
8. What is meant by administrative approval?
9. Discuss any two types of construction budgets.
10. Explain the sources of long-term financing of construction projects.

PART B**(Answer one full question from each module, Each question carries 14 marks)****Module 1**

11. a) Explain the Functions of construction project management.
b) Describe any two types of organisation structures for construction projects.
12. With an example, explain the procedure for the time-cost tradeoff.

Module 2

13. Explain any two labour legislations pertaining to the construction industry.
14. Explain the following
 - i) BIM Model
 - ii) Clash Detection
 - iii) Model Based Cost Estimating
 - iv) Dimensions of BIM

Module 3

15. Explain the need for Quality assurance and Quality control in construction projects.
16. Discuss in detail ABC analysis for Material Management

Module 4

17. a) Give the salient features of the contract document.
b) Explain any two important conditions of the contract.
18. Discuss the major steps involved in E Tendering and the process of awarding the contract.

Module 5

19. Analyse the important benefits of the following:
 - i) Fund Flow Analysis
 - ii) Financial Ratio Analysis
20. Explain, with examples, the different Methods for Estimating Working Capital Requirement.



CET463	ADVANCED ENVIRONMENTAL ENGINEERING	CATEGORY	L	T	P	CREDIT	YEAR OF INTRODUCTION
		PEC	3	0	0	3	2019

Preamble: This course introduces students to the state of technologies that exist for treating water and air. They will learn basic engineering principles that govern these technologies and develop the capacity to select appropriate technologies for solving environmental problems related to water and air pollution.

Prerequisite: CET 304 Environmental Engineering

Course Outcomes: After the completion of the course the student will be able to

Course Outcome	Description of Course Outcome	Prescribed learning level
CO1	Explain various secondary treatment technologies for waste water	Understand
CO2	Explain various tertiary treatment technologies and their applications	Understand
CO3	Explain engineering principles to dimension various treatment units	Analyse
CO4	Identify appropriate technology for controlling air pollution	Understand

Mapping of course outcomes with program outcomes (Minimum requirement)

	PO 1	PO 2	PO 3	PO 4	PO 5	PO 6	PO 7	PO 8	PO 9	PO 10	PO 11	PO 12
CO 1	3	-	3	-	-	-	-	-	-	-	-	-
CO 2	3	-	3	-	-	-	-	-	-	-	-	-
CO 3	3	-	3	-	-	-	-	-	-	-	-	-
CO4	3	-	3	-	-	-	-	-	-	-	-	-

Assessment Pattern

Bloom's Category	Continuous Assessment Tests		End Semester Examination
	1	2	
Remember	10	10	15
Understand	10	10	15
Apply	15	15	35
Analyse	15	15	35
Evaluate			
Create			

Mark distribution

Total Marks	CIE	ESE	ESE Duration
150	50	100	3 hours

Continuous Internal Evaluation Pattern:

Attendance : 10 marks
 Continuous Assessment Test (2 numbers) : 25 marks
 Assignment/Quiz/Course project : 15 marks

End Semester Examination Pattern: There will be two parts; Part A and Part B. Part A contain 10 questions with 2 questions from each module, having 3 marks for each question. Students should answer all questions. Part B contains 2 questions from each module of which student should answer any one. Each question carries 14 marks and can have maximum 2 sub-divisions.

Course Level Assessment Questions**CO1: Explain various secondary treatment technologies for waste water**

1. Explain the working principle of a Rotating Biological Contactor.
2. What are the sequential steps of sequencing batch reactor (SBR) operation?
3. Moving bed biofilm reactor (MBBR) is an advanced wastewater treatment technology, which employs the benefits of both biofilm and activated sludge processes. Explain

CO 2: Explain various tertiary treatment technologies and their applications

1. What is Fenton process?
2. Discuss the biological removal of phosphorous in waste water.
3. What are the various configurations available for MBR?

CO3: Explain engineering principles to dimension various treatment units

1. Calculate the maximum efficiency for a RO plant, which is operated with a inlet pressure of 45 bar and under the condition that effective driving force $\Delta p_{\text{eff min}} = 15$ bar is maintained. The permeate pressure is 1 bar, pressure loss is 3 bar and mass fraction of salt in permeate (W_p) = 0. Feed is a NaCl solution with mass fraction (W_f) = 0.03 and the osmotic coefficient is 790 bar. How big is the membrane area if 10 m³/h of permeate are to be produced and a membrane with $A = 1,2 \cdot 10^{-7}$ m/(s.bar) was chosen?
2. A design wastewater flow 7571 m³/d is to be treated with an MBR treatment system. The design membrane module properties are, average membrane flux= 12 L/hr/m²; module packing

density= $120\text{m}^2/\text{m}^3$; specific aeration demand= $0.3\text{ m}^3\text{ air/hr/m}^2$ membrane area. Calculate the required membrane area, membrane module volume and scouring air flow rate.

3. An ESP is collecting 95% of the particles in the waste gas. A salesperson now offers us an additive to add to the gas that will change the resistivity of the collected cake of particles, thus doubling the effective drift velocity. If we use this additive, what will be the improvement in collection efficiency?

CO4: Identify appropriate technology for controlling air pollution

1. Compare baghouse filters with cyclone separators in terms of the efficiency of particulate removal from a gas stream.
2. How sulfur oxides can be controlled?
3. Wet scrubbing is useful for the removal of both particulate and gaseous pollutants. Explain

Syllabus

Module 1

Advances in waste water treatment –Process for biological nitrogen removal –Process for biological phosphorus removal - anoxic-aerobic process design – sequencing batch reactor (SBR)

Module 2

Aerobic attached growth Process – Rotating Biological Contactor (RBC), Moving Bed Biofilm Reactor (MBBR)

Advanced Oxidation Processes- Fenton process, Wet Air Oxidation process, Photo-Oxidation process

Module 3

Adsorption- Removal of organic and inorganic contaminants- Popular adsorbents-Adsorption Isotherms-Breakthrough Curves in Continuous Adsorption Processes- Adsorption in a Batch Contactor-Adsorption kinetics-Regeneration of spent adsorbents

Ion Exchange-method of purification-Applications in water treatment

Module 4

Membrane Technology- Reverse Osmosis (RO)- Ultra Filtration(UF)- Nano Filtration(NF)- Micro Filtration(MF)- Electro Dialysis (ED)-Dimensioning of RO units for desalination.

Tertiary filtration of waste water- design of Membrane Bio Reactors(MBR), MBR configurations.

Module 5

Air Pollution Control- Control devices for Particulate pollutants –Cyclone separators, baghouse filters, wet scrubbers, electrostatic precipitators (ESP)- Design of an ESP

Gaseous pollutant control-technologies for the control of sulfur oxides, nitrogen oxides and carbon monoxide- wet scrubbing, process modification.

Text Books:

1. Howard S Peavy, Donald R Rowe and George Tchobanoglous, Environmental Engineering, Mc Graw Hill Education , 2013
2. Mackenzie L Davis, David A Cornwell, Introduction to Environmental Engineering, Mc Graw Hill Education, 2014
3. Gilbert M Masters, Introduction to Environmental Engineering and Science, Pearson Education India; 3rd edition, 2015
4. J. Arceivala, Shyam R. Asolekar, Wastewater Treatment for Pollution Control and Reuse, McGrawhill Education, 2007
5. S.K. Garg, Sewage disposal and air pollution engineering, Khanna Publishers. 2008

References:

1. Metcalf and Eddy, Waste Water Engineering, Tata McGraw Hill publishing Co Ltd, 2003
2. Syed R Qasim, Wastewater Treatment Plants-Planning, Design & Operation, CRC Press,1999
3. Baker, Membrane Technology and Applications, 3rd ed., Wiley-Blackwell 2012
4. Fane, Schaefer, Waite, Nanofiltration, Principles and applications, Elsevier 2004
5. Peinemann, Nunez, Membrane Technology, 6 vols, Wiley-vch 2007 – 2010

Course Contents and Lecture Schedule

Module	Topic	Course Outcomes addressed	No. of Lectures
1	Module 1: Total Lecture Hours -7		
1.1	Process for biological nitrogen removal-design criteria	CO2	2
1.2	Process for biological phosphorus removal-design criteria	CO2	2
1.3	anoxic-aerobic process design – sequencing batch reactor (SBR)	CO1	3
2	Module II: Total Lecture Hours- 7		
2.1	Aerobic attached growth Process – Rotating Biological Contactor (RBC)	CO1	2
2.2	Moving Bed Biofilm Reactor (MBBR)	CO1	2
2.3	Advanced Oxidation Processes- Fenton process, Wet Air Oxidation process, Photo-Oxidation process	CO2	3
3	Module III: Total Lecture Hours-7		
3.1	Adsorption- Removal of organic and inorganic contaminants- Popular adsorbents	CO2	1
3.2	Adsorption Isotherms	CO2	2
3.3	Breakthrough Curves in Continuous Adsorption Processes-	CO2	2

	Adsorption in a Batch Contactor- Adsorption kinetics		
3.4	Regeneration of spent adsorbents	CO2	1
3.5	Ion Exchange-method of purification-Applications in water treatment	CO2	1
4	Module IV: Total Lecture Hours- 7		
4.1	Membrane Technology- Reverse Osmosis (RO)- Ultra Filtration(UF)- Nano Filtration(NF)- Micro Filtration(MF)- Electro Dialysis (ED)	CO3	2
4.2	Dimensioning of RO units for desalination	CO3	2
4.3	Tertiary filtration of waste water- design of Membrane Bio Reactors(MBR), MBR configurations.	CO2, CO3	3
5	Module V: Total Lecture Hours- 7		
5.1	Air Pollution Control- Control devices for Particulate pollutants –Cyclone separators, baghouse filters, wet scrubbers, electrostatic precipitators (ESP)	CO4	3
5.2	Design of an ESP	CO3, CO4	1
5.3	Gaseous pollutant control-technologies for the control of sulfur oxides, nitrogen oxides and carbon monoxide- wet scrubbing, process modification	CO4	3



Model Question Paper

Reg No.: _____

Name: _____

**APJ ABDUL KALAM TECHNOLOGICAL UNIVERSITY
SEVENTH SEMESTER B.TECH DEGREE EXAMINATION****Course Code: CET 463****Course Name: ADVANCED ENVIRONMENTAL ENGINEERING**

Max. Marks: 100

Duration: 3 Hours

Part A*(Answer all questions; each question carries 3 marks)*

1. Explain denitrification.
2. What are the sequences of operation in an SBR?
3. How advanced oxidation processes (AOP) helps in treating waste water?
4. What is the difference in the biological process of an RBC and MBBR?
5. What are adsorption isotherms?
6. How ion exchange can soften water?
7. What is Ultra filtration?
8. Explain the benefits of MBR treatment system.
9. How cyclones remove particles from a gas stream.
10. what is desulfurization?

PART B*(Answer one full question from each module, each question carries 14 marks)***Module 1**

11. (a) Explain the process for biological nitrogen removal (9 Marks)
(b) How anoxic process is different from anaerobic process? (5 Marks)

OR

12. (a) Explain the working of an SBR (6 Marks)
(b) Explain the treatment technologies available for phosphorous removal in waste water (8 Marks)

Module 2

13. (a) Explain the working principle of an MBBR (6 Marks)
 (b) Discuss Advanced Oxidation Processes (8 Marks)

OR

14. (a) How aerobic attached process compare with aerobic suspended process (5 Marks)
 (b) What is the application of Wet Air Oxidation process (5 Marks)
 (c) How biological process in RBC is different from that in MBBR (4 Marks)

Module 3

15. (a) List some popular adsorbents. How they are regenerated after use? (4 Marks)
 (b) Explain breakthrough curve in continuous adsorption process. (5 Marks)
 (c) What are the applications of ion exchange process in water treatment? (5 Marks)

OR

16. (a) Explain the significance of adsorption processes in environmental engineering (7 Marks)
 (b) Explain various adsorption kinetics models (7 Marks)

Module 4

17. (a) Explain the working principle of Electro Dialysis (6 Marks)
 (b) Calculate the maximum efficiency for a RO plant, which is operated with a inlet pressure of 45 bar and under the condition that effective driving force $\Delta p_{\text{eff min}} = 15$ bar is maintained. The permeate pressure is 1 bar, pressure loss is 3 bar and mass fraction of salt in permeate (W_p) = 0. Feed is a NaCl solution with mass fraction (W_f) = 0.03 and the osmotic coefficient is 790 bar. How big is the membrane area if 10 m³/h of permeate are to be produced and a membrane with $A = 1.2 \cdot 10^{-7}$ m/(s.bar) was chosen? (8 marks)

OR

18. (a) Explain the working of Membrane Bio Reactors. What are the different configurations available for MBRs? (6 Marks)
 (b) A design wastewater flow 7571 m³/d is to be treated with an MBR treatment system. The design membrane module properties are, average membrane flux = 12 L/hr/m²; module packing density = 120 m²/m³; specific aeration demand = 0.3 m³ air/hr/m² membrane area. Calculate the required membrane area, membrane module volume and scouring air flow rate. (8 Marks)

Module 5

19. (a) Wet scrubbing is useful for the removal of both particulate and gaseous pollutants. Explain (6 Marks)
 (b) As an air pollution control engineer, explain what air pollution control measures you will adopt at a Coal fired thermal power plant and why? (8 Marks)

OR

20. (a) Discuss the source reduction measures for oxides of nitrogen (6 Marks)

(b) Explain the principle of electrostatic precipitator. Discuss the advantages and limitations of electrostatic precipitators. (8 Marks)



CET473	OPTIMISATION TECHNIQUES IN CIVIL ENGINEERING	CATEGORY	L	T	P	CREDIT	YEAR OF INTRODUCTION
		PEC	3	0	0	3	2019

Preamble: Optimization techniques in civil engineering is a subject which provide the basic concepts of optimization problem formulation in various civil engineering fields. Optimization has application in all fields of engineering. This course introduces different algorithms for solving structural optimization problems. After this course the students will be able to identify the type of the real-world optimization problems and design the corresponding optimization techniques.

Course Outcomes: After the completion of the course the students will be able to:

Course Outcome	Description of Course Outcome	Prescribed learning level
CO1	Formulate engineering design problem as an optimization problem.	Applying
CO2	Apply suitable optimization technique to the design problem at hand.	Applying
CO3	Evaluate the problem as linear or nonlinear optimization problem and design the optimization technique.	Evaluate
CO4	Evaluate the problem as single variable or multi-variable optimization problem and design the corresponding optimization technique	Evaluate
CO5	Formulate linear programming problem for engineering applications and evaluate the solution.	Evaluate
CO6	Familiarise with transportation and assignment problems and genetic algorithm.	Applying

Mapping of course outcomes with programme outcomes

	PO 1	PO 2	PO 3	PO 4	PO 5	PO 6	PO 7	PO 8	PO 9	PO 10	PO 11	PO 12
CO 1	3	3	3	3	2	-	-	-	-	-	2	2
CO 2	3	3	3	3	3	-	-	-	-	-	2	2
CO 3	3	3	3	3	3	-	-	-	-	-	2	2
CO 4	3	3	3	3	3	-	-	-	-	-	2	2
CO 5	3	3	3	3	3	3	2	-	-	-	2	2
CO 6	3	3	3	3	3	3	2	-	-	-	2	2

Bloom's Category	Continuous Assessment		End Semester Examination Marks
	Test 1 Marks	Test 2 Marks	
Remember	-	-	
Understand	10	-	10
Apply	10	10	20
Analysis	10	20	30
Evaluate	20	20	40
Create			

Mark distribution

Total Marks	CIE	ESE	ESE Duration
150	50	100	3 hours

Continuous Internal Evaluation Pattern:

Attendance	: 10 marks
Continuous Assessment Test (2 numbers)	: 25 marks
Assignment/Quiz/Course project	: 15 marks

End Semester Examination Pattern:

There will be two parts; Part A and Part B. Part A contain 10 questions with 2 questions from each module, having 3 marks for each question. Students should answer all questions. Part B contains 2 questions from each module of which student should answer any one. Each question carries 14 marks and can have maximum 2 sub-divisions.

Course Level Assessment Questions

(Questions may be framed based on the outline given under each course outcome)

Course Outcome 1 (CO1): Formulate engineering design problem as an optimization problem.

1. Formulate a optimization problem with constraints for determining the optimum dimensions of a simply supported beam of span 6 m subjected to a uniformly distributed load of 30 kN/m. Allowable stress in bending is 10N/mm^2 and allowable stress in shear is 1N/mm^2 . Allowable deflection is span/300.

2. Formulate a optimization problem with constraints for determining the optimal slope and dimensions for the members of the truss if the shape, loads and span are given.

Course Outcome 2 (CO2): Apply suitable optimization technique to the design problem at hand.

1. Find the optimum dimensions of a simply supported beam of span 6 m subjected to a uniformly distributed load of 30 kN/m. Allowable stress in bending is 10N/mm^2 and allowable stress in shear is 1N/mm^2 . Allowable deflection is span/300.
2. Find the optimal slope and dimensions for the members of the truss if the shape, loads and span are given.

Course Outcome 3 (CO3): Evaluate the problem as linear or nonlinear optimization problem and design the optimization technique.

1. Calculate the minimum of the given function by unrestricted search, exhaustive search and interval halving methods.

$$f(x) = 0.65 - 0.75/(1+x^2) - 0.65x \tan^{-1}(1/x)$$

2. Using Newton Raphson method find the minimum of the function $f(x) = xe^x - \cos x$
3. Minimize the function by Golden section method and Fibonacci method

$$f(x) = 2\sin x - x^2 / 10 \text{ in the interval } (0,10)$$

Course Outcome 4 (CO4): Evaluate the problem as single variable or multi-variable optimization problem and design the corresponding optimization technique.

1. Minimize the function by univariate method

$$f(x_1, x_2) = x_1 - x_2 + 2x_1^2 + 2x_1x_2 + x_2^2$$
2. Write down the algorithm for Powell's conjugate direction method
3. Write down the algorithm for Hooke and Jeeve's pattern search method

Course Outcome 5 (CO5): Formulate linear programming problem for engineering applications and evaluate the solution.

1. Express the given problem in the standard form

$$\text{Maximize } z = 3x_1 + 5x_2 + 7x_3 \text{ subject to}$$

$$6x_1 - 4x_2 \leq 5; 3x_1 + 2x_2 + 5x_3 \geq 11; 4x_1 + 2x_2 \geq 2; x_1, x_2 \geq 0$$

2. Determine the minimum value of the objective function

$$Z = -50x + 20y \text{ subject to the constraints}$$

$$2x - y \geq -5 ; 3x + y \geq 3 ; 2x - 3y \leq 12 ; x \geq 0, y \geq 0$$

3. A dietician has to develop a special diet using two foods P and Q. Each packet (containing 30 g) of food P contains 12 units of calcium, 4 units of iron, 6 units of cholesterol and 6 units of vitamin A. Each packet of the same quantity of food Q contains 3 units of calcium, 20 units of iron, 4 units of cholesterol and 3 units of vitamin A. The diet requires atleast 240 units of calcium, atleast 460 units of iron and at most 300 units of cholesterol. How many packets of each food should be used to minimise the amount of vitamin A in the diet? What is the minimum amount of vitamin A?

Course Outcome 6 (CO6): Familiarise with transportation and assignment problems and genetic algorithm

1. There are two factories located one at place P and the other at place Q. From these locations, a certain commodity is to be delivered to each of the three depots situated at A, B and C. The weekly requirements of the depots are respectively 5, 5 and 4 units of the commodity while the production capacity of the factories at P and Q are respectively 8 and 6 units. The cost of transportation per unit is given below:

From/To	Cost in (Rs)		
	A	B	C
P	160	100	150
Q	100	120	100

How many units should be transported from each factory to each depot in order that the transportation cost is minimum. What will be the minimum transportation cost?

2. A company manufactures two products P1 and P2. The company has two types of machines A and B. Product P1 take 2 hours on machine A and 4 hours on machine B, whereas product P2 takes 5 hours on machine A and 2 hours on machine B. The profit realised on the sale of one unit of product P1 is Rs.3 and that of product P2 is Rs. 4. If machine A and B can operate 24 and 16 hours per day respectively, determine the weekly out put for each product in order to maximise the profit. (Assume a 5day week).

Syllabus

Module -1

Introduction to optimization methods- optimization problem formulation - objective function, constraints. Classification of optimization problems. Geometric, graphical, analytical methods of optimization. Application examples from engineering.

Module -2

Single Variable Unconstrained Optimisation Techniques- Optimality Criteria. Bracketing methods: Unrestricted search, Exhaustive search. Region Elimination methods: Interval Halving methods, Dichotomous search, Fibonacci method, Golden section method. Interpolation methods: Quadratic Interpolation method, Cubic Interpolation method. Gradient Based methods: Newton-Raphson method, Secant method, Bisection method.

Module -3

Multivariable Unconstrained Optimisation Techniques- Optimality Criteria- Unidirectional Search. Direct Search methods: Random search, Grid search, Univariate method, Hooke's and Jeeves' pattern search method, Powell's conjugate direction method, Simplex method. Gradient based methods: Cauchy's (Steepest descent) method, Conjugate gradient (Fletcher Reeves) method, Newton's method, Variable metric (DFP) method, BFGS method.

Module -4

Linear programming, simplex method- dual problem, weak duality theorem, optimality criterion theorem, main duality theorem, complementary slackness theorem, primal-dual relationship, economic interpretation of dual solution, introduction to sensitivity analysis examples of applications of linear programming in engineering.

Module -5

Transportation problem- Assignment problem- applications of linear programming problems in Civil Engineering- Introduction to Genetic Algorithms- basic concept- problem formulation - operations- convergence criteria.

Text Books:

1. Rajasekharan S. "Numerical Methods in Science and Engineering" S Chand & company 2003.
2. S.S. Rao, Optimisation Theory and applications, Wiley Eastern.
3. Belegundu., Optimisation concepts and Applications Engineering.
4. S. S. Rao, Engineering Optimization, New Age International (P) Ltd. Publishers.
5. J. S. Arora, Introduction to Optimum Design, McGraw-Hill Book Company.
6. K. Deb, Multiobjective Optimization using Evolutionary Algorithms, John Wiley and Sons.

Reference Books:

1. Grewal B.S. “Numerical Methods in Engineering and Science” Khanna Publishers.
2. Chapra S.C. and Canale R.P. “Numerical Methods for Engineers” Mc Graw Hill 2006.
3. Ketter and Prawel “Modern Methods for Engineering Computations” Mc Graw Hill
4. Terrence. J. Akai “Applied Numerical Methods for Engineers”, Wiley publishers 1994.
5. R.L. Fox, Optimisation methods in Engineering Design, Addison Wesley
6. Ravindran, D. T. Phillips, J. J. Solberg, Operations Research – Principles and Practice, John Wiley and Sons.
7. Ravindran, K. M. Ragsdell, G. V. Reklaitis, Engineering Optimization – Methods and Applications, John Wiley and Sons.
8. M. S. Bazaraa, H. D. Sherali, and C. M. Shetty, Nonlinear Programming: Theory and Algorithms, Wiley-Interscience.
9. Rajasekharan S. “Numerical Methods for Initial and Boundary value problems,” Khanna publishers 1989.

Module	Contents	Course Outcomes addressed	No. of Lectures
1	Module 1: Total lecture hours:7		
1.1	Introduction to optimization methods	1	1
1.2	Problem formulation, objective function, constraints	1	1
1.3	Classification of optimization problems.	1	1
1.4	Geometric methods of optimization	2	1
1.5	Graphical methods of optimization	2	1
1.6	Analytical methods of optimization	2	1
1.7	Application examples from engineering.	1	1
2	Module 2: Total lecture hours: 6		
2.1	Single Variable Unconstrained Optimisation Techniques, Optimality Criteria.	3, 4	1
2.2	Bracketing methods: Unrestricted search, Exhaustive search.	3, 4	1

2.3	Region Elimination methods: Interval Halving methods, Dichotomous search	3, 4	1
2.4	Fibonacci method, Golden section method	3, 4	1
2.5	Interpolation methods: Quadratic Interpolation method, Cubic Interpolation method.	3, 4	1
2.6	Gradient Based methods: Newton-Raphson method, Secant method, Bisection method	3, 4	1
3	Module 3: Total lecture hours: 8		
3.1	Multivariable Unconstrained Optimisation Techniques	3, 4	1
3.2	Optimality Criteria- Unidirectional Search.	3, 4	1
3.3	Direct Search methods: Random search, Grid search	3, 4	1
3.4	Univariate method, Hooke's and Jeeves' pattern search method	3, 4	1
3.5	Powell's conjugate direction method, Simplex method	3, 4	1
3.6	Gradient base methods: Cauchy's (Steepest descent) method,	3, 4	1
3.7	Conjugate gradient (Fletcher Reeves) method	3, 4	1
3.8	Newton's method, Variable metric (DFP)method, BFGS method.	3, 4	1
4	Module 4: Total lecture hours: 8		
4.1	Linear programming, simplex method	5	1
4.2	Dual problem, weak duality theorem	5	1
4.3	Optimality criterion theorem, main duality theorem	5	1
4.4	Complementary slackness theorem	5	1
4.5	Primal-dual relationship, economic interpretation of	5	1

	dual solution		
4.6	Introduction to sensitivity analysis	5	1
4.7	Examples of applications of linear programming in engineering.	5	1
4.8	Numerical Examples	5	1
5	Module 5: Total lecture hours: 6		
5.1	Transportation problem	6	1
5.2	Assignment problem	6	1
5.3	Numerical Examples	6	1
5.4	Applications of linear programming problems in Civil Engineering	6	1
5.5	Introduction to Genetic Algorithms, Basic concept - problem formulation	6	1
5.6	Operations- convergence criteria.	6	1



Model Question Paper

Reg No.: _____

Name: _____

APJ ABDUL KALAM TECHNOLOGICAL UNIVERSITY
SEVENTH SEMESTER B.TECH DEGREE EXAMINATION, MONTH & YEAR

Course Code: CET473

Course Name: OPTIMISATION TECHNIQUES IN CIVIL ENGINEERING

Max. Marks: 100

Duration: 3 hours

Part A

(Answer all questions; each question carries 3 marks)

1. What is the difference between a bound point and a free point in the design space?
2. What is graphical optimisation and what are its limitations?
3. What is the basis of the interval halving method?
4. What is the difference between quadratic and cubic interpolation methods?
5. Give three reasons why the study of unconstrained minimization methods is important.
6. Why is Powell's method called a pattern search method?
7. State an LPP problem in standard form.
8. Why is linear programming important in several types of industries?
9. How can we represent a standard genetic algorithm?
10. Explain the cycle of genetic algorithm.

PART B

(Answer one full question from each module, each question carries 14 marks)

11. (a). Explain the general steps involved in formulation of optimisation model (6 Marks)
 (b) A uniform column of rectangular cross section is to be constructed for supporting a water tank of mass M . It is required (1) to minimize the mass of the column for economy, and (2) to maximize the natural frequency of transverse vibration of the system for avoiding possible resonance due to wind. Formulate the problem of designing the column to avoid failure due to direct compression and buckling. Assume the permissible compressive stress to be σ_{\max} . (8 Marks)
- OR
12. (a) State any six engineering applications of optimization. (6 Marks)

- (b) Formulate a optimization problem with constraints for determining the optimum dimensions of a simply supported beam of span 6 m subjected to a uniformly distributed load of 30 kN/m. Allowable stress in bending is 10N/mm² and allowable stress in shear is 1N/mm². Allowable deflection is span/300. (8 Marks)

13. Find the minimum of the following function using Newton Raphson method with the starting point $x_1 = 0.1$. $f(x) = 0.65 - 0.75/(1+x^2) - 0.65x \tan^{-1}(1/x)$ (14 marks)

OR

14. (a) What is the difference between Fibonacci and golden section methods? (6 Marks)
 (b) Find the minimum of $f = x(x - 1.5)$ in the interval (0.0,1.00) to within 10% of the exact value by exhaustive search method (8 Marks)
15. (a) Minimize $f(x_1, x_2) = x_1 - x_2 + 2x_1^2 + 2x_1x_2 + x_2^2$ with the starting point (0,0) by Hooke and Jeeves method (14 Marks)

OR

16. (a) Show that the DFP method is a conjugate gradient method. (7 Marks)
 (b) Prove that the gradient vector represents the direction of steepest ascent. (7 marks)

17. (a) Maximise $F = x_1 + 2x_2 + x_3$ subject to
 $2x_1 + x_2 - x_3 \leq 2$
 $-2x_1 + x_2 - 5x_3 \geq 6$
 $4x_1 + x_2 + x_3 \leq 6$
 $x_i \geq 0, i = 1, 2, 3$ (14 Marks)

OR

18. A dietician has to develop a special diet using two foods P and Q. Each packet (containing 30 g) of food P contains 12 units of calcium, 4 units of iron, 6 units of cholesterol and 6 units of vitamin A. Each packet of the same quantity of food Q contains 3 units of calcium, 20 units of iron, 4 units of cholesterol and 3 units of vitamin A. The diet requires atleast 240 units of calcium, atleast 460 units of iron and at most 300 units of cholesterol. How many packets of each food should be used to minimise the amount of vitamin A in the diet? What is the minimum amount of vitamin A? (14 Marks)

19. There are two factories located one at place P and the other at place Q. From these locations, a certain commodity is to be delivered to each of the three depots situated at A, B and C. The weekly requirements of the depots are respectively 5, 5 and 4 units of the commodity while the production capacity of the factories at P and Q are respectively 8 and 6 units. The cost of transportation per unit is given below:

From/To	Cost in (Rs)		
	A	B	C
P	160	100	150
Q	100	120	100

How many units should be transported from each factory to each depot in order that the transportation cost is minimum. What will be the minimum transportation cost?

(14 marks)

OR

20. A company manufactures two products P1 and P2. The company has two types of machines A and B. Product P1 take 2 hours on machine A and 4 hours on machine B, whereas product P2 takes 5 hours on machine A and 2 hours on machine B. The profit realised on the sale of one unit of product P1 is Rs.3 and that of product P2 is Rs. 4. If machine A and B can operate 24 and 16 hours per day respectively, determine the weekly out put for each product in order to maximise the profit. (Assume a 5day week).

(14 marks)



APJ ABDUL KALAM
TECHNOLOGICAL
UNIVERSITY

SEMESTER VII

OPEN ELECTIVE



CET415	ENVIRONMENTAL IMPACT ASSESSMENT	CATEGORY	L	T	P	CREDIT	YEAR OF INTRODUCTION
		OEC	2	1	0	3	2019

Preamble : This course introduces the methodologies for identifying, predicting, evaluating and mitigating the impacts on environment due to any developmental project or activities. Students will learn how to prepare an impact assessment report and devise an environment management plan. Sufficient background will be provided on the environmental clearance procedures in India.

Prerequisite: NIL

Course Outcomes: After the completion of the course the student will be able to

Course Outcome	Description of Course Outcome	Prescribed learning level
CO1	Explain the need for minimizing the environmental impacts of developmental activities	Understand
CO2	Outline environmental legislation & clearance procedure in the country	Remember, Understand
CO 3	Apply various methodologies for assessing the environmental impacts of any developmental activity	Apply & Analyse
CO 4	Prepare an environmental impact assessment report	Analy & Evaluate
CO 5	Conduct an environmental audit	Analyse & Evaluate

Mapping of course outcomes with program outcomes (Minimum requirement)

	PO 1	PO 2	PO 3	PO 4	PO 5	PO 6	PO 7	PO 8	PO 9	PO 10	PO 11	PO 12
CO 1	-	-	-	-	-	2	2	-	-	-	-	-
CO 2	-	-	-	-	-	2	-	-	-	-	-	-
CO 3	2	-	-	3	2	-	3	-	-	-	-	-
CO4	-	-	-	2	-	2	2	3	-	3	-	-
CO5	-	-	-	2	1	-	2	2	-	2	-	-

Assessment Pattern

Bloom's Category	Continuous Assessment Tests		End Semester Examination
	1	2	
Remember	10	10	15
Understand	10	10	15
Apply	15	15	35
Analyse	15	15	35
Evaluate			
Create			

Mark distribution

Total Marks	CIE	ESE	ESE Duration
150	50	100	3 hours

Continuous Internal Evaluation Pattern:

Attendance	: 10 marks
Continuous Assessment Test (2 numbers)	: 25 marks
Assignment/Quiz/Course project	: 15 marks

End Semester Examination Pattern:

There will be two parts; Part A and Part B. Part A contain 10 questions with 2 questions from each module, having 3 marks for each question. Students should answer all questions. Part B contains 2 questions from each module of which student should answer any one. Each question carries 14 marks and can have maximum 2 sub-divisions.

Course Level Assessment Questions**CO1: Explain the need for minimizing the environmental impacts of developmental activities**

- 1.Explain the evolution of EIA in India
- 2.Explain why EIA is needed for developmental projects.

3. What are the different ways in which development projects impact the water quality and quantity?

CO 2: Outline the environmental legislation & clearance procedure in the country

1. Two municipalities in Kerala plan to set up a Common Municipal Solid Waste Management Facility (CMSWMF). Explain the procedure required for the Environmental Clearance (EC) for the project as per the EIA Notification of 2006. (All CMSWMFs are category B projects)

2. Describe the procedure for obtaining environmental clearance according to EIA notification 2006.

3. The Environment (Protection) Act, 1986 is called an umbrella legislation. Substantiate the statement.

CO3: Apply various methodologies for assessing the environmental impacts of any developmental activity

1. Prepare a simple checklist for assessment of socio economic impact due to the development of a highway.

2. Explain overlay mapping as an EIA method

3. Explain how to predict the impact of a highway project on air quality

CO4: Prepare an environmental impact assessment report

1. Explain the Terms of Reference (ToR) for EIA report of a highway project

2. Explain the structure of EIA report

3. Explain the importance of an environmental management plan.

CO5: Conduct an environmental audit

1. Explain the need for environmental auditing

2. What are the different types of environmental audits?

3. Explain the importance of ISO 14001 standard.

Syllabus

Module 1

Definition, Need for EIA, Evolution of EIA: Global & Indian scenario -Environmental legislations in India- The Water (Prevention & Control of Pollution) Act 1974, The Air (Prevention & Control of Pollution) Act 1981, The Environmental (Protection) Act 1986- Environmental standards for water, air and noise quality- EIA Notification 2006

Module 2

Environmental clearance process in India: Screening, Scoping, Public Consultation, Appraisal- Form1-Category of projects- Generic structure of EIA report- Terms of Reference (ToR) -Types of EIA: strategic, regional, sectoral, project level- Rapid EIA and Comprehensive EIA- Initial Environmental Examination (IEE)

Module 3

EIA methodologies: Ad hoc, checklist, matrix, network and overlay- Impact Prediction, Evaluation and Mitigation-Prediction and assessment of the impact on water (surface water and groundwater), air, and noise environment- assessment of ecological impacts and Socio economic Impacts.

Module 4

Environmental Management Plan (EMP): Goal and purpose- Importance of EMP- Content of an EMP- Role of environmental monitoring program
Environment Audit: need for audit- audit types and benefits- environmental audit procedure
ISO 14001 standards: Importance, salient features - Stages in implementation- Benefits

Module 5

EIA case studies (Indian)- a highway project, a hydro electric power plant, an air port project, a quarry mining project and a solid waste management project

Text Books:

1. Larry W Canter, "Environmental Impact Assessment", McGraw Hill Inc. , New York, 1995
2. Betty Bowers Marriott, Environmental Impact Assessment: A Practical Guide, McGraw-Hill Professional, 1997
3. Environmental Impact Assessment, 2003, Y.Anjaneyulu, B.S Publications

References:

1. Lawrence, David P., Environmental Impact Assessment (Practical Solutions to Recurrent Problems), Wiley International, New Jersey.
2. Ministry of Environment & Forests, Govt. of India 2006 EIA Notification
3. Jain, R.K., Urban, L.V. and Stacey, G.S., Environment Impact Analysis, Von Nostrand Reinhold Company.

Course Contents and Lecture Schedule

Module	Topic	Course Outcomes addressed	No. of Lectures
1	Module 1: Total Lecture Hours -7		
1.1	Definition, Need for EIA, Evolution of EIA: Global & Indian scenario	CO1	1
1.2	Environmental legislations in India- The Water (Prevention & Control of Pollution) Act 1974, The Air (Prevention & Control of Pollution) Act 1981, The Environmental (Protection) Act 1986	CO2	3
1.3	Environmental standards for water, air and noise quality	CO2	1
1.4	EIA Notification 2006	CO2	2
2	Module II: Total Lecture Hours- 7		
2.1	Environmental clearance process in India: Screening, Scoping, Public Consultation, Appraisal- Form1-Category of projects	CO2	3
2.2	Generic structure of EIA report- Terms of Reference (ToR)	CO4	1
2.3	Types of EIA: strategic, regional, sectoral, project level-	CO3	1
2.4	Rapid EIA and Comprehensive EIA	CO3	1
2.5	Initial Environmental Examination (IEE)	CO3	1
3	Module III: Total Lecture Hours-7		
3.1	EIA methodologies: Ad hoc, checklist, matrix, network and overlay	CO3	3
3.2	Impact Prediction, Evaluation and Mitigation- Prediction and assessment of the impact on water (surface water and groundwater), air, and noise	CO3	2

	environment		
3.3	assessment of ecological impacts and Socio economic Impacts	CO3	2
4	Module IV: Total Lecture Hours- 7		
4.1	Environmental Management Plan (EMP): Goal and purpose- Importance of EMP- Content of an EMP	CO4	2
4.2	Role of environmental monitoring program	CO4	1
4.3	Environment Audit: need for audit- audit types and benefits- environmental audit procedure	CO5	2
4.4	ISO 14001 standards: Importance, salient features - Stages in implementation- Benefits	CO5	2
5	Module V: Total Lecture Hours- 7		
5.1	EIA case studies (Indian)- a highway project	CO1, CO4	2
5.2	Hydro electric power plant, air port project	CO1, CO4	3
5.3	Quarry mining project, solid waste management project	CO1, CO4	3

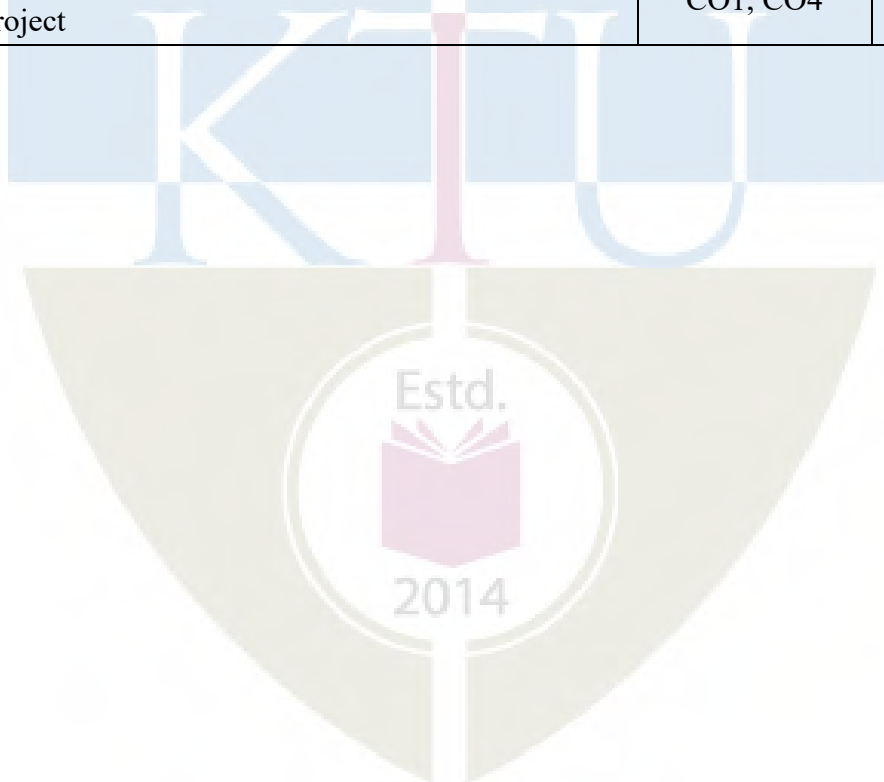

Model Question Paper

Reg No.:-----

Name:_____

APJ ABDUL KALAM TECHNOLOGICAL UNIVERSITY**SEVENTH SEMESTER B.TECH DEGREE EXAMINATION****Course Code: CET415****Course Name: ENVIRONMENTAL IMPACT ASSESSMENT**

Max. Marks: 100

Duration: 3

Hours

Part A*(Answer all questions; each question carries 3 marks)*

1. Explain the need for EIA
2. Why environmental (protection) act, 1986 is called an umbrella act?
3. Discuss screening of projects
4. What is rapid EIA?
5. What is ad hoc method for impact assessment?
6. How to predict the impact of a proposed food industry on the water quality of a nearby river
7. Explain the benefits of an environmental audit
8. What is ISO 14001 standard?
9. What are the impacts of a highway project on local air quality
10. Discuss the environment monitoring program for a quarry mining industry.

PART B*(Answer one full question from each module, each question carries 14 marks)***Module 1**

11. (a) Discuss environmental standards for water, air and noise (6 Marks)
- (b) Discuss evolution of EIA in India (8 Marks)

OR

12. (a) Discuss Air (Prevention & Control of Pollution) Act 1981 (5 Marks)
- (b) Explain salient features of EIA notification 2006 (9 Marks)

Module 2

13. (a) Discuss environmental clearance process in India (10 Marks)
- (b) What is Form-1 ? (4 Marks)

OR

14. (a) What is Initial Environmental Examination? (5 Marks)
(b) Explain different types of EIA (9 Marks)

Module 3

15. (a) Discuss in detail EIA methodologies (10 Marks)
(b) How can air quality modelling help in assessing the impact on air (4 Marks)

OR

16. (a) Explain the steps to assess the impacts on the ecological environment due to a project (7 Marks)
(b) Explain the steps involved in assessment of impacts on the water environment.

Module 4

17. (a) What are the different types of Environmental Audit? (5 Marks)
(b) Discuss the content of an environment management plan (9 marks)

OR

18. (a) Discuss the salient features of an Environmental Monitoring Plan (5 Marks)
(b) Explain in detail the procedure for conducting an environmental audit (9 Marks)

Module 5

19. Explain environmental clearance procedure for an airport (14 Marks)
OR
20. Discuss how to assess the impacts of a hydro electric project (14 Marks)

Estd.



2014

CET425	APPLIED EARTH SYSTEMS	CATEGORY	L	T	P	CREDIT	YEAR OF INTRODUCTION
		OEC	2	1	0		

Preamble: Objective of the course is to appreciate the concept of earth system and its interrelated components, the processes and mechanisms thereof.

Prerequisite: Nil

Course Outcomes:

CO 1	Explain the concept of earth as a system of interrelated components and associated exogenic/endogenic processes.
CO 2	Appraise geological agents and their respective erosion, transportation and deposition regimes and landforms formed.
CO 3	Contemplate constraints and processes that continuously affect earth's surface and its stability and consistency.
CO 4	Evaluate/investigate the significance of Plate tectonics theory to explain the geodynamic features and processes of earth's surface.
CO 5	Develop an understanding of oceanographic and atmospheric regimes and their sway on other subsystems and process thereof.
CO 6	Understand implications of human interaction with the Earth system.

Mapping of course outcomes with program outcomes

	PO1	PO2	PO3	PO4	PO5	PO6	PO7	PO8	PO9	PO10	PO11	PO12	PSO1	PSO2
CO 1	3	2		2		3	3	2				3		
CO 2	3	3		3		3	3		1			3		
CO 3	3	3		3		3	3	2	1		3	3		
CO 4	3	3		3		3	3					3		
CO 5	3	3	2	3		3	3					3		
CO 6	2	3		2		3	3	3				3		

Assessment Pattern

Bloom's Category	Continuous Assessment		End Semester Examination (marks)
	Test 1 Marks	Test 2 Marks	
Remember	3	3	10
Understand	4	4	15
Apply	-	-	-
Analyse	9	9	37
Evaluate	9	9	38
Create			

Mark Distribution

Total Marks	CIE (Marks)	ESE (Marks)	ESE Duration
150	50	100	3 hours

Continuous Internal Evaluation Pattern:

Attendance	: 10 marks
Continuous Assessment Test (2 numbers)	: 25 marks
Assignment/Quiz/Course Project	: 15 marks

End Semester Examination Pattern:

The question consists of two parts- Part A and Part B. Part A consists of 10 questions with 3 marks for each (two questions from each module). Part B consists of two questions from each module, out of which one has to be answered. Each question carries 14 marks and can have maximum 2 subdivisions.

Sample Course Level Assessment Questions:**1 Course Outcome 1 (CO1):**

Explain, citing examples the subsystems of earth interact with each other.

2 Course Outcome 2 (CO2):

Appraise the processes involved in any erosional or depositional feature of rivers.

3 Course Outcome 3 (CO3):

Discuss the controls that give rise to mass movements.

4 Course Outcome 4 (CO4):

Analyse the distribution of seismicity and volcanism with respect to plate dynamics.

5 Course Outcome 5 (CO5):

Examine ecological significance of coral reefs and implications of global warming on them.

6 Course Outcome 6 (CO6):

Assess the effect of human activities enhance the vulnerability of environment.

Syllabus

Module	Contents	Hours
I	Fundamental concepts of equilibrium. Geomorphic agents and processes. Basic concept of Earth as a system and its component sub systems. Climate Change vis-a-vis the interrelationships of the subsystems	5
II	Weathering- relevance, influence of and on earth systems, types and controlling factors Fluvial processes-hydrological cycle, fluvial erosion, transportation and deposition, fluvial landforms. Stages of stream development; Drainage patterns.	6
III	Soil- formation and controls, soil profile, soil erosion and conservation methods. Deserts-distribution and controls.	7
IV	Wagner's ideas of continental drift, Plate Tectonics- seafloor spreading. Plate boundaries and their features, mechanisms of plate movements.	6
V	Basics of oceanography: coastal upwelling and downwelling. Outlines of ocean floor topography, Brief account of marine sediments, turbidity currents, basic outlines of origin and circulation of deep-sea surface currents (Atlantic and Pacific Oceans), coral reefs- types and concepts about their formation. Basics of atmosphere and atmospheric processes: Structure and composition of the atmosphere. Heat budget, factors affecting solar radiation. Green House Effect and Global warming, basic ideas about their causes and effects	12 (6+6)

Text/Reference Books

1. Critchfield H. General Climatology Prentice Hall, New Delhi, 1983
2. Fetter C. Applied Hydrogeology CBS New Delhi, 1990
3. Carlson, DH, Plummer, CC and McGreary, D Physical geology: Earth Revealed McGraw Hill New York, 2006
4. Pinet PR Oceanography – An Introduction to the Planet Oceanus, West Publishing Co, 1992
5. Ritter, DF, Kochel, RC and Miller, JR. Process Geomorphology Wm.C. Brown Publishers New York, 1995
6. Soman K Geology of Kerala Geological Society of India, Bangalore, 2001

Course Content and lecture Schedule:

No.	Topic	Course Outcome	Hours
Module I			
1.1	Basic concept of Earth as a system, interactions between its component sub systems.	CO1, CO5, CO6	1
1.2	Fundamental concepts of equilibrium	CO1, CO3	2
1.3	Geomorphic agents and processes	CO1, CO2, CO3	2
Module II			
2.1	Weathering- relevance, influence of and on earth systems Types and controlling factors	CO1, CO2, CO3	2
2.2	River as a system, Fluvial processes-hydrological cycle, fluvial erosion, transportation and deposition and landforms	CO1, CO2, CO3	2
2.3	Stages of stream development	CO1, CO2, CO3	1
2.4	Drainage patterns and implications	CO1, CO2, CO3, CO4	1
Module III			
3.1	Soil- significance and controls, soil profile	CO1, CO2, CO3, CO6	2
3.2	Soil erosion and conservation methods	CO1, CO2, CO3, CO6	3
3.3	Deserts-distribution and controls	CO2, CO3	2
Module IV			
4.1	Wagner's ideas of continental drift, limitations	CO2, CO3, CO4	2
4.2	Plate Tectonics- background of the theory, evidences	CO2, CO3, CO4	1
4.3	Plate boundaries and their features, seismicity and volcanism	CO2, CO3, CO4	2
4.4	vis-à-vis plates Mechanisms of plate movements	CO2, CO3, CO4	1
Module V			
5.1	Importance of marine environment	CO1, CO2, CO3	1
5.2	Circulation in oceans- surface circulation in deep sea (Atlantic and Pacific Oceans), coastal upwelling and downwelling	CO1, CO2, CO3	2
5.3	Outlines of ocean floor topography, brief account of marine sediments	CO1, CO2, CO3	2
5.4	Turbidity currents	CO1, CO2, CO3	1
5.5	Coral reefs- types and concepts about their formation.	CO1, CO2, CO3	2
5.6	Structure and composition of the atmosphere	CO1, CO2, CO3, CO6	2
5.7	Heat budget, radiation balance of earth, Green House Effect and Global warming, basic ideas about their causes and effects	CO1, CO2, CO3, CO6	2

Model Question Paper**APJ ABDUL KALAM TECHNOLOGICAL UNIVERSITY
SEVENTH SEMESTER B.TECH DEGREE EXAMINATION****Course Code: CET425
APPLIED EARTH SYSTEMS**

Marks:100

Duration: 3 hours

PART A**(Answer all questions. Each question carries three marks)**

1. Natural slopes are in dynamic equilibrium. Appraise.
2. Assess the significance of different soil horizons.
3. Examine the conditions that give rise to parallel drainage pattern.
4. Describe features associated with convergent plate boundaries.
5. Assess the fossil evidences that support the idea of continental drift.
6. Compare creep and solifluction.
7. Assess the conditions of coral bleaching.
8. Appraise the increasing temperature with elevation in stratosphere.
9. Evaluate the role of latitudinal distribution in the formation of Hadley cells.
10. Explain the role of ocean currents in the formation of deserts.

PART B**(Answer one full question from each module)****MODULE 1**

11. There are mass and energy interactions between the subsystems of earth. Justify with two examples. (14)

OR

12. Assess the feedback mechanisms involved in controlling the mean sea-level. (14)

MODULE 2

13. Evaluate the controls (any four) on chemical weathering. (14)

OR

14. Examine the processes of fluvial erosion and transportation. (14)

MODULE 3

15. Evaluate the factors giving rise to aridity. (14)

OR

16. Discuss the influence of climate, slope and rock structure on occurrence on soil genesis. (14)

MODULE 4

17. a) Examine any two evidences put forth by Wagner that support continental drift. (8)

b) Relate convection currents in mantle to plate movements. (6)

OR

18. Appraise the significance of plate boundaries on seismicity and volcanism. (14)

MODULE 5

19. a) Explain the implications of ozone, water vapour and carbon dioxide in troposphere. (7)

b) How are turbidity currents formed? (7)

OR

20. a) Examine the heat budget of earth. (7)

b) Assess the significance of zooxanthellae in the maintenance of coral reefs. (7)



CET435	INFORMATICS FOR INFRASTRUCTURE MANAGEMENT	CATEGORY	L	T	P	CREDIT	YEAR OF INTRODUCTION
		OEC	2	1	0	3	2019

Preamble: This course is aimed at exposing the students to the scope of Informatics and Internet of Things (IoT) in Civil Engineering. It introduces students to the fundamentals of data analytics, informatics & IoT as it is applicable to civil engineering field. After this course, students will be in a position to appreciate the use of informatics & IoT in civil engineering projects and follow the future developments in this sector.

Prerequisite: NIL

Course Outcomes:

After the completion of the course the students will be able to

Course Outcome	Description of Course Outcome	Prescribed learning level
CO 1	Explain the fundamental concepts of data science, informatics & internet of things	Remembering, Understanding
CO 2	Identify the use of geomatics in planning and site selection of infrastructure projects	Applying & Analysing
CO 3	Apply building informatics in construction, monitoring and project management	Applying & Analysing
CO4	Utilize IoT technology in infrastructure management	Applying & Analysing

Mapping of course outcomes with program outcomes (Minimum requirement)

	PO 1	PO 2	PO 3	PO 4	PO 5	PO 6	PO 7	PO 8	PO 9	PO 10	PO 11	PO 12
CO 1	2	-	-	-	-	-	-	-	-	-	-	-
CO 2	2	-	-	-	2	-	-	-	-	-	-	2
CO 3	2	-	-	-	2	-	-	-	-	-	-	2
CO4	2	-	-	-	2	-	-	-	-	-	-	2

Assessment Pattern

Bloom's Category	Continuous Assessment Tests		End Semester Examination
	1	2	
Remember	10	10	15
Understand	10	10	15
Apply	15	15	35
Analyse	15	15	35
Evaluate			
Create			

Mark distribution

Total Marks	CIE	ESE	ESE Duration
150	50	100	3 hours

Continuous Internal Evaluation Pattern:

Attendance	: 10 marks
Continuous Assessment Test (2 numbers)	: 25 marks
Assignment/Quiz/Course project	: 15 marks

End Semester Examination Pattern: There will be two parts; Part A and Part B. Part A contain 10 questions with 2 questions from each module, having 3 marks for each question. Students should answer all questions. Part B contains 2 questions from each module of which student should answer any one. Each question carries 14 marks and can have maximum 2 sub-divisions.

Course Level Assessment Questions

(Questions may be framed based on the outline given under each course outcome)

Course Outcome 1 (CO1):

Explain the fundamental concepts of data science, informatics & internet of things.

1. Explain DIKW pyramid.
2. Explain the data mining techniques
3. Discuss different data models
4. Discuss the vector data analysis techniques
5. Explain COBie standard

6. List IoT protocols
7. What are the elements of BIM?

Course Outcome 2 (CO2):

Identify the use of geomatics for planning and site selection of infrastructure projects.

1. Discuss how geomatics help in site selection of a solid waste management facility
2. Discuss how terrain modeling is an important geographic information for project planning

Course Outcome 3 (CO3):

Apply building informatics in construction, monitoring and project management.

1. How BIM helps in reducing the cost of construction?
2. Discuss the steps in developing a BIM for an infrastructure project.

Course Outcome 4 (CO4):

Utilise IoT technology in infrastructure management.

1. How a water supply system could benefit by IoT technology?
2. Monitoring infrastructure projects could leverage from IoT technologies! Discuss.

Syllabus

Module 1

Data to Information

History of informatics, DIKW pyramid, data management- data types, Meta data, database management systems; Data analysis techniques-spatial and non-spatial data, trends and patterns

Module 2

Geoinformatics

Fundamental concepts in Geo-informatics- Components, Spatial data and attributes, vector and raster data models, Vector data analysis-buffering, overlay; Raster data analysis- local operations, neighborhood operations, zonal operations

Module 3

Planning and Site selection

Application of geoinformatic systems: Site suitability analysis- Residential area, Industrial area and a Reservoir. Zoning- Ground water potential zonation, Hazard zonation
Network Analysis- Water supply line, Power line and a Road network

Module 4**Building Informatics**

Building Information Modelling- Definition, Elements of BIM, steps in BIM development, COBie standard, potential and applications of BIM

Module 5**Internet of Things (IoT) in Civil Infrastructure**

IoT Standards & Protocols, Concept of IoT in civil engineering- Applications in construction, product monitoring and project Management

Management Applications- Traffic Regulation, Water Supply and Smart Buildings

Text Books

1. J. Campbell, Essentials of Geographic Information Systems, Saylor Foundation, 2011.
2. RamezElmasri, ShamkantB.Navathe, "Fundamental of Database Systems", Pearson Addison Wesley, 2003.
3. BIM Handbook: A Guide to Building Information Modeling for Owners, Designers, Engineers, Contractors, and Facility Managers, Publisher: John Wiley & Sons; 2nd edition (1 July 2011), Language: English, ISBN-10: 9780470541371

Reference Books

1. Raja R. A. Issa and Svetlana Olbina, Building Information Modeling: Applications and Practices, ASCE, 2015.
2. Samuel Greengard, The internet of things, The MIT Press Essential Knowledge Series, 2015, ISBN: 978-0-262-52773-6.
3. ShashiShekhar and Sanjay Chawla, "Spatial Databases:A Tour", Prentice Hall, 2003.
4. Building Information Modeling: BIM in Current and Future Practice, Publisher: John Wiley & Sons; 1 edition (15 August 2014), Language: English, ISBN-10: 9781118766309

Course Contents and Lecture Schedule

Module	Topic	Course outcomes addressed	No. of Lectures
1	Module I : Total lecture hours : 7		
1.1	History of informatics	CO1	Lecture 1
1.2	DIKW pyramid & Meta data	CO1	Lecture 2
1.3	Data management	CO1	Lecture 3
1.4	Data types & Meta data	CO1	Lecture 4
1.5	Database management systems	CO1	Lecture 5
1.6	Data analysis techniques	CO1	Lecture 6
1.7	Trends & Patterns in data analysis	CO1	Lecture 7
2	Module II : Total lecture hours : 7		
2.1	Fundamental concepts in Geo-informatics-	CO1	Lecture 1
2.2	Components of GIS	CO1	Lecture 2
2.3	Spatial data and attributes	CO1	Lecture 3
2.4	Data models- vector & raster	CO1	Lecture 4
2.5	Vector data analysis	CO1	Lecture 5
2.6	Raster data analysis- local & neighbourhood analysis	CO1	Lecture 6
2.7	Raster data analysis- zonal analysis	CO1	Lecture 7
3	Module III : Total lecture hours : 7		
3.1	Site suitability analysis for Residential area	CO2	Lecture 1
3.2	Site suitability analysis for Industrial area	CO2	Lecture 2
3.3	Site suitability analysis for reservoir	CO2	Lecture 3
3.4	Ground water potential zonation & Hazard zonation mapping	CO2	Lecture 4
3.5	Network analysis for water supply	CO2	Lecture 5
3.6	Network analysis for power line	CO2	Lecture 6

3.7	Network analysis for road network	CO2	Lecture 7
4	Module IV : Total lecture hours : 7		
4.1	Building Information Modelling- Definition	CO3	Lecture 1
4.2	Elements of BIM	CO3	Lecture 2& 3
4.3	Steps in BIM development	CO3	Lecture 4 & 5
4.4	COBie standard	CO3	Lecture 6
4.5	Potential & applications of BIM	CO3	Lecture 7
5	Module V : Total lecture hours : 7		
5.1	IoT Standards & Protocols, Concept of IoT in civil engineering	CO4	Lecture 1
5.2	Application of IoT in construction, product monitoring & project management	CO4	Lecture 2,3 & 4
5.3	Management applications of IoT- Traffic, water supply, smar buildings	CO4	Lecture5,6 & 7

Model Question Paper

Reg No.: _____ Name: _____

APJ ABDUL KALAM TECHNOLOGICAL UNIVERSITY
SEVENTH SEMESTER B.TECH DEGREE EXAMINATION, MONTH & YEAR

Course Code: CET 435

Course Name: INFORMATICS FOR INFRASTRUCTURE MANAGEMENT

Max. Marks: 100

Duration: 3 hours

Part A

(Answer all questions; each question carries 3 marks)

1. Explain different data types.
2. Explain DIKW pyramid.
3. Compare vector & raster model.
4. What are the components of GIS?
5. Explain network analysis.
6. What is the importance of terrain modeling?
7. Define BIM.

8. What is COBie standard?
9. List the IoT protocols.
10. Explain the concept of smart buildings.

PART B

(Answer one full question from each module, each question carries 14 marks)

11. (a) Discuss data analysis techniques for spatial data. (5 Marks)
- (b) Explain the steps in processing data into information. (9 Marks)

OR

12. (a) Briefly describe the history of informatics (5 Marks)
- (b) Explain various data analysis techniques. (9 Marks)
13. (a) Discuss various components of GIS (5 Marks)
- (c) Explain various vector analysis techniques. (9 Marks)

OR

14. (a) Explain buffering analysis. What is its application? (5 Marks)
- (b) Explain various raster data analysis techniques. (9 Marks)
15. (a) How the site suitability analysis is carried out for a reservoir? (7 Marks)
- (b) Explain how geomatics is useful for mapping hazard zones. (7 Marks)

OR

16. (a) Explain the methodology for road network analysis. (7 Marks)
- (b) Explain the process of converting data to information for a industrial area selection. (7 Marks)
17. (a) What are the applications of BIM? (5 Marks)
- (b) Discuss the steps in developing a BIM for an infrastructure project. (9 marks)

OR

18. (a) Explain the elements of BIM. (5 Marks)
- (b) How BIM helps in reducing the cost of construction? (9 Marks)
19. (a) What sensors & devices would help in monitoring water distribution network. (5 Marks)
- (b) Infrastructure management could leverage from IoT technologies! Discuss. (9 Marks)

OR

20. (a) What are the selection criteria for sensors & devices used in IoT technologies. (7 Marks)
- (b) Discuss how IoT technologies could help in traffic management. (7 Marks)



CET445	NATURAL DISASTERS AND MITIGATION	CATEGORY	L	T	P	CREDIT	YEAR OF INTRODUCTION
		OEC	2	1	0	3	2019

Preamble : Objective of the course is to introduce the concept of disasters, their causes and their mitigation and management.

Prerequisite: Nil

Course Outcomes: After the completion of the course the student will be able to

CO 1	Explain interaction between subsystems of earth that give rise to hazards and their potential for disasters
CO 2	Explain the evolving concepts and thoughts of management of hazards and disasters
CO 3	Analyse the causes behind natural disasters and evaluate their magnitude and impacts
CO 4	Create management plans for hazards and disasters, and understand the roles of agencies involved.
CO 5	Explain the concept of sustainable development and EIA and their role in mitigating disasters

Mapping of course outcomes with program outcomes

	PO1	PO2	PO3	PO4	PO5	PO6	PO7	PO8	PO9	PO10	PO11	PO12
CO 1	2	1	-	2	1	2	3	1	-	1	1	3
CO 2	2	1	-	2	1	3	3	1	-	1	1	3
CO 3	1	2	2	3	3	3	2	2	2	2	1	3
CO 4	2	1	3	2	3	2	3	2	2	1	3	3
CO 5	2	2	3	2	1	3	3	2	1	2	2	3

Assessment Pattern

Bloom's Category	Continuous Assessment		End Semester Examination (marks)
	Test 1 Marks	Test 2 Marks	
Remember	5	5	20
Understand	5	5	20
Apply	-	-	-
Analyse	5.5	5.5	22
Evaluate	5.5	5.5	22
Create	4	4	16

Mark Distribution

Total Marks	CIE (Marks)	ESE (Marks)	ESE Duration
150	50	100	3 hours

Continuous Internal Evaluation Pattern:

Attendance	: 10 marks
Continuous Assessment Test (2 numbers)	: 25 marks
Assignment/Quiz/Course Project	: 15 marks

End Semester Examination Pattern:

The question consists of two parts- Part A and Part B. Part A consists of 10 questions with 3marks for each (two questions from each module). Part B consists of two questions from each module, out of which one has to be answered. Each question carries 14 marks and can have maximum 2 subdivisions.

Sample Course Level Assessment Questions:**Course Outcome 1:**

Citing a few examples known to you, discuss how disaster differs from a hazard.

Course Outcome 2 :

Compare a few earthquakes in history based on their magnitude and degree of damage.

Course Outcome 3:

Discuss how the potentiality for volcanic eruption may be assessed.

Course Outcome 4:

Based on any disaster in an infrastructure project, prepare a report on how following EIA rules could have abated the disaster.

Course Outcome 5:

Prepare a disaster management plan in case of a landslide on a Railway track near to a station.

Syllabus

Module	Contents	Hours
1	Hazards and disasters: Introduction to key concepts and terminology: hazard, disasters and types of classifications, vulnerability, exposure, risk, crisis, emergency, capacity, resilience, Carbon footprint. Effect of subsystems of earth. Urbanisation, hazards and disasters.	3
2	Extent and nature of natural hazards, implications of climate change: Earth quakes, Volcanoes, Floods. Coastal disasters- Storm surges, Tsunamis, mitigation methods.	8
3	Landslides, Soil and soil degradation, erosion and Desertification, Forest fires, their mitigation methods.	7
4	Impacts and assessment: Risk Management and Assessment and Disaster Management cycle. SWOT Analysis- basic concepts, uses, limitations and advantages. Disaster management plan and reports, participation of community in disaster management.	8
5	Hazard and disaster management plans for floods, storm surges, landslides, earthquakes, forest fires: pre-disaster phase, actual disaster phase, post-disaster phase- Relief and Amenities, Relief camps, organization, individual and community participation, camp layout, food requirement, water needs, sanitation, security, information administration. Concepts of EIA and sustainable development. Technology in disaster management.	9

Text Books

1. Ariyabandu, M. and Sahni P. "Disaster Risk Reduction in South Asia", Prentice-Hall (India), 2003.
2. Valdiya, K.S. "Environmental Geology - Ecology, Resource and Hazard Management". McGraw-Hill Education (India) Private Limited. 2013
3. Shaw, R and Krishnamurthy, RR (Ed.) "Disaster Management: Global Problems and Local Solutions". Universities Press (India) Ltd. 2009
4. Gupta, H.K. (Ed.), "Disaster management". Universities Press (India) Ltd. 20038.
5. Jha, M.K. (Ed.) "Natural and Anthropogenic Disasters- Vulnerability, Preparedness and Mitigation". Springer, Amsterdam. 2010
6. Nick Carter. W., "Disaster Management - A Disaster Manager's Handbook". Asian Development Bank, Philippines. 1991
7. U.N.O, "Mitigating Natural Disasters, Phenomena, Effects and options, A Manual for policy makers and planners", United Nations. New York, 1991

References

1. Andrew, S., “Environmental Modeling with GIS and Remote Sensing”, John Willey, 2002
2. Bell, F.G., “Geological Hazards: Their assessment, avoidance and mitigation”, E & FN SPON Routledge, London. 1999
3. Bossler, J.D., “Manual of Geospatial Science and Technology”, Taylor and Francis, 2001
4. Alexander, D., “Natural Disasters”, Research Press, New Delhi, 1993
5. Girard, J. “Principles of Environmental Chemistry”. Jones & Bartlett Publishers, New York. 2013
6. Khorram-Manesh, A. (Ed.). “Handbook of Disaster and Emergency Management”. Kompendiet (Gothenburg). 2017
7. Mason, I., McGuire, B., and Kilburn, C., “Natural Hazards and Environmental Change (Key Issues in Environmental Change)”. Routledge, London. 2002

Model Question Paper

**APJ ABDUL KALAM TECHNOLOGICAL UNIVERSITY
SEVENTH SEMESTER B. TECH DEGREE EXAMINATION**

Course Code: CET445

Course Name: NATURAL DISASTERS & MITIGATION

Marks:100

Duration: 3 hours

PART A

(Answer all questions. Each question carries three marks)

1. With a typical example explain how a hazard differs from a disaster
2. Explain the terms: vulnerability and risk and how they contribute to disasters
3. Enumerate natural disasters, and mention their impacts.
4. How are earthquakes caused? What is the connection between earthquake and tsunami?
5. How is soil formed? Why do soils differ in characteristics?
6. Compare creep and solifluction.
7. What is meant by a pre-disaster plan? Give an example.
8. How is environmental impact connected to disasters?
9. Evaluate the pre-disaster measures for landslides.
10. Compare risk and vulnerability assessment.

PART B

(Answer one full question from each module)

11. a) Describe how an infrastructure project could trigger disaster. (6)
b) How does resilience influence the recovery from a disaster? Illustrate with examples. (8)
- OR**
12. Bring out the differences between emergency and disaster. How is the risk for a disaster assessed? (14)
13. What are the causes of floods? How do they decide the magnitude of impact? (14)
- OR**
14. Discuss the triggering factors for landslides. Illustrate how they could become disastrous in the case of an infrastructure project. (14)
15. Evaluate the factors giving rise to forest fires. Analyse the influence of climate change on them. (14)
- OR**
16. How does desertification occur? Discuss the mitigation measures. (14)
17. Compare and contrast the concepts of disaster response and recovery with suitable examples. (14)
- OR**
18. Appraise (with suitable examples) the significance of ideas of relief, rehabilitation, reconstruction and recovery in disaster management. (14)
19. Prepare a disaster management plan for a landslide scenario in a hilly terrain. Discuss the organisational set up needed for the same. (14)
- OR**
20. Discuss the various factor to be considered in conducting environmental impact assessment of a highway project, keeping in mind the probable hazards/disasters. (14)

Course Contents and Lecture Schedule

No.	Topic	Course Outcome	No. of Hrs
1	Module 1		Total: 3
1.1	Introduction, Hazard, disaster, their characteristics and effects, interaction between subsystems of earth that bring about hazards and their intensification. Classification, how development is connected to disasters. Disaster cycle	CO1, CO2	2
1.2	Hazard and disaster Terminology: vulnerability and types, exposure, risk, capacity, crisis, emergencies, resilience etc. basic concepts of carbon footprint	CO1, CO4	1
2	Module 2		Total: 8
2.1	Natural Disasters: General classification, Causes, types, impact of: Earth quakes, volcanoes, floods, storm surges, tsunamis	CO1, CO2, CO3	3
2.2	Assessment and mitigation of: Floods, types Coastal disasters: Earth quakes, volcanoes, floods, storm surges, tsunamis.	CO1, CO2, CO3	5
3	Module 3		Total: 7
3.1	Soil, formation, significance and characteristics. Soil degradation, engineering and agricultural methods of prevention	CO1, CO3, CO4	2
3.2	Desertification: nature and mechanisms, mitigation	CO2, CO3, CO4	1
3.3	Landslides: processes, controlling factors, classification and impact and alleviation	CO2, CO3, CO4	2
3.4	Forest fires: incidence and means and deterrence	CO1, CO3, CO4	2
4	Module 4		Total: 8
4.1	Steps in Risk Management and Assessment, Disaster management cycle-Prevention, Preparedness, Response, and Recovery	CO1, CO3, CO4	3
4.2	SWOT Analysis- concepts, uses, limitations and advantages	CO2, CO3, CO4	3
4.3	Disaster management plan and reports, participation of community in disaster management	CO3, CO4, CO5	2
5	Module 5		Total: 9
5.1	Hazard and Disaster Management: relief camps, organisation and amenities. Behavioral aspects of management- psychological considerations, training in human professionalism, individual and community empowerment	CO1, CO2, CO4	2

5.2	Management of floods, storm surges, landslides, earthquakes, forest fires: pre-disaster phase, actual disaster phase, post-disaster phase. Relief and Amenities, Relief camps, organization, camp layout, food requirement, water needs, sanitation, security.	CO3, CO4, CO5	5
5.3	Concepts of EIA and sustainable development.	CO5	2

APJ ABDUL KALAM
TECHNOLOGICAL
UNIVERSITY



CET455	ENVIRONMENTAL HEALTH AND SAFETY	CATEGORY	L	T	P	CREDIT	YEAR OF INTRODUCTION
		OEC	2	1	0	3	2019

Preamble: The course is designed to build environmental health literacy among students and encourages them to take safety measures against various environmental hazards. It motivates the students in maintaining and improving the quality of the environment and empower learners to take appropriate actions to reduce the environment pollution.

Pre-requisite: Nil

Course outcome : After the course, the student will able to:

CO1	Explain the Toxicology and Occupational Health associated with industries.
CO2	Identify chemical and microbial agents that originate in the environment and can impact human health.
CO3	Describe various measures to ensure safety in Construction industry.
CO4	Explain the effect of air and water pollution on environment.
CO5	Describe the safety measures against various environmental hazards.

Mapping of course outcomes with program outcomes

	PO1	PO2	PO3	PO4	PO5	PO6	PO7	PO8	PO9	PO10	PO11	PO12
CO1	3					2	2					
CO2	3					2	1					
CO3	3					2	2					
CO4	3					3	2					
CO5	3					2	2					

Assessment pattern

Bloom's Category	Continuous Assessment Tests		End Semester Examination (Marks)
	Test 1 (Marks)	Test 2 (Marks)	
Remember	15	15	30
Understand	20	20	40
Apply			
Analyze	15	15	30
Evaluate			
Create			

Continuous Internal Evaluation Pattern:

Attendance	:	10 marks
Continuous Assessment Test (2 numbers)	:	25 marks
Assignment/Quiz/Course project	:	15 marks
Total	:	50 marks

End semester examination pattern – There will be two parts; Part A and Part B. Part A contain 10 questions with 2 questions from each module, having 3 marks for each question. Students should answer all questions. Part B contains 2 questions from each module of which student should answer any one. Each question can have maximum 2 sub-divisions and carry 14 marks.

Course Level Assessment Questions

Qn. No	Question	Marks	Course outcome (CO) Assessed
Part A			
1	What are the socio- economic reasons in safety?	3	CO1
2	Define industrial hygiene.	3	CO1
3	Define noise. What are the compensation aspects of noise?	3	CO2
4	Explain about the biohazard control program.	3	CO2

5	Discuss the possible electrical injuries in a construction industry.	3	CO3
6	What are the hazards due to radiation?	3	CO3
7	What are the criteria air pollutants?	3	CO4
8	Describe the Depletion of Ozone Layer.	3	CO4
9	What are the benefits of safety inspection?	3	CO5
10	Discuss the role of an individual in conservation of natural resources.	3	CO5
Part B (Answer ANY ONE FULL question from each module)			
Module I			
11	Briefly explain about occupational related diseases found in the industries.	14	CO1
12	Write the short notes on : (i) Silicosis (ii) Asbestosis (iii) Anthracosis (iv) Anthrax.	14	CO1
Module II			
13(a)	Write briefly about the classification of bio hazardous agents.	7	CO2
13(b)	What are the precautionary measures for chemical hazards?	7	CO2
14	Write short notes on : (i) Vapour (ii) Fog (iii) Dust (iv) Fumes.	14	CO2
Module III			
15	Explain effects of radiation on human body and the methods of radioactive waste disposal.	14	CO3
16(a)	What are the requirements for safe work platform?	7	CO3
16(b)	Discuss about the scaffolding inspections.	7	CO3
Module IV			

17	Describe the effect of air pollution on environment.	14	CO4
18	Describe the effect of water pollution on environment.	14	CO4
Module V			
19 (a)	What is First aid? Explain CPR.	7	CO5
19 (b)	What are the important points to be considered in carrying out workplace inspection?	7	CO5
20 (a)	Explain the first aid measure to be taken during i)gas poisoning, ii)heart attack, iii)chemical splash and iv)electric shock.	10	CO5
20 (b)	Briefly explain the elementary first aid.	4	CO5

Syllabus

Module I

Introduction to Occupational Health And Toxicology: Safety at work – Socio – Economic reasons. Introduction to health and safety at various industries. occupational related diseases- Musculoskeletal disorders, hearing impairment, carcinogens, silicosis, asbestosis, pneumoconiosis – Toxic materials and substances used in work, exposure limits, toxicological investigation, Industrial Hygiene, Arrangements by organisations to protect the workers.

Module II

Chemical hazards- Dust, fumes, vapour, fog, gases; Methods of Control. **Biological hazards-** Classification of Biohazardous agents– bacterial agents, viral agents, fungal, parasitic agents, infectious diseases, control of biological agents at workplaces. Noise, noise exposure regulation and control.

Module III

Safety in Construction industry - Scaffolding and Working platform, Welding and Cutting, Excavation Work, Concreting, control measures to reduce the risk. Electrical Hazards, Protection against voltage fluctuations, Effects of shock on human body. Radiation Hazards, Types and effects of radiation on human body, disposal of radioactive waste.

Module IV

Air Pollution - air pollutants from industries, effect on human health, animals, plants and materials - depletion of ozone layer-concept of clean coal combustion technology.

Water Pollution - water pollutants-health hazards - effluent quality standards. Waste Management -waste identification, characterization and classification, recycling and reuse.

Module V

Safe working environment - The basic purpose and benefits of safety inspection, First-aid appliances, shelters, rest rooms and lunch rooms, use of personal protective equipment, Role of an individual in conservation of natural resources, Methods for controlling water pollution, role of individual in prevention of pollution.

Text Books:

1. Environmental and Health and Safety Management by By Nicholas P. Cheremisinoff and Madelyn L. Graffia, William Andrew Inc. NY, 1995.
2. Effective Environmental, Health, and Safety Management Using the Team Approach by Bill Taylor, Culinary and Hospitality Industry Publications Services 2005.
3. The Facility Managers Guide to Environmental Health And Safety by Brian Gallant, Government Inst Publ., 2007.
4. R.K.Jain and Sunil S.Rao , Industrial Safety , Health and Environment Management Systems, Khanna publishers , New Delhi (2006).
5. Mackenzie L Davis, Introduction to Environmental Engineering, McGrawhill Education (India).

References:

1. Slote. L, Handbook of Occupational Safety and Health, JohnWileyand Sons, NewYork.
2. Heinrich H.W, Industrial Accident Prevention, McGrawHill Company,NewYork,1980.
3. S.P.Mahajan, "Pollution control in process industries", Tata McGraw Hill Publishing Company, New Delhi, 1993.

Course content and Schedule of Lecture

Module	Topic	Course outcome addressed	No of Hours
Module I (7 Hours)			
1.1	Introduction to Occupational Health And Toxicology.	CO1	1
1.2	Safety at work – Socio – Economic reasons.	CO1	
1.3	Introduction to health and safety at various industries.	CO1	1
1.4	Occupational related diseases- Musculoskeletal disorders, hearing impairment	CO1	1
1.5	Occupational related diseases - carcinogens, silicosis, asbestosis, pneumoconiosis.	CO1	1
1.6	Toxic materials and substances used in work.	CO1	1
1.7	Exposure limits, toxicological investigation.	CO1	1
1.8	Industrial Hygiene.	CO1	1
1.9	Arrangements by organisations to protect the workers.	CO1	
Module II (7 Hours)			
2.1	Chemical hazards.	CO2	1
2.2	Dust, fumes, vapour, fog, gases.	CO2	
2.3	Methods of Control.	CO2	1
2.4	Biological hazards.	CO2	1
2.5	Classification of Biohazardous agents.	CO2	
2.6	Bacterial agents, viral agents, fungal, parasitic agents, infectious diseases.	CO2	1
2.7	Control of biological agents at workplaces.	CO2	1
2.8	Noise.	CO2	1
2.9	Noise exposure regulation and control.	CO2	1

Module III (7 Hours)

3.1	Safety in Construction industry- Scaffolding and Working platform.	CO3	1
3.2	Welding and Cutting, Excavation Work, Concreting.	CO3	
3.3	Control measures to reduce the risk.	CO3	1
3.4	Electrical Hazards.	CO3	1
3.5	Protection against voltage fluctuations.	CO3	1
3.6	Effects of shock on human body, Radiation Hazards	CO3	1
3.7	Types and effects of radiation on human body.	CO3	1
3.8	Disposal of radioactive waste.	CO3	1

Module IV (7 Hours)

4.1	Air Pollution - air pollutants from industries.	CO4	1
4.2	Effect on human health, animals.	CO4	
4.3	Plants and Materials - depletion of ozone layer.	CO4	1
4.4	Concept of clean coal combustion technology.	CO4	1
4.5	Water Pollution - water pollutants.	CO4	1
4.6	Health hazards - effluent quality standards.	CO4	1
4.7	Waste Management-waste identification.	CO4	1
4.8	Characterization and classification.	CO4	1
4.9	Recycling and reuse.	CO4	

Module V (7 Hours)

5.1	Safe working environment.	CO5	1
5.2	The basic purpose and benefits of safety inspection.	CO5	
5.3	First-aid appliances.	CO5	1

5.4	Shelters, rest rooms and lunch rooms.	CO5	1
5.5	Use of personal protective equipment.	CO5	1

5.6	Role of an individual in conservation of natural resources.	CO5	1
5.7	Methods for controlling water pollution.	CO5	1
5.8	Role of individual in prevention of pollution.	CO5	1

Model Question Paper

Reg. No.:.....

QP CODE:.....

Name:.....

**APJ ABDUL KALAM TECHNOLOGICAL UNIVERSITY
SEVENTH SEMESTER B.TECH DEGREE EXAMINATION, MONTH & YEAR
COURSE CODE: CET 455
ENVIRONMENTAL HEALTH AND SAFETY**

Max. Marks: 100

Duration: 3 hours

Part A

(Answer all questions; each question carries 3 marks)

1. What are the socio- economic reasons in safety?
2. Define industrial hygiene.
3. Define noise. What are the compensation aspects of noise?
4. Explain about the biohazard control program.
5. Discuss the possible electrical injuries in a construction industry.
6. What are the hazards due to radiation?
7. What are the criteria air pollutants?
8. Describe the Depletion of Ozone Layer.

9. What are the benefits of safety inspection?
10. Discuss the role of an individual in conservation of natural resources.

Part B

(Answer one full question from each module; each question carries 14 marks)

Module I

11. Briefly explain about occupational related diseases found in the industries. (14 Marks)

OR

12. Write the short notes on : (14 Marks)
- (i) Silicosis
 - (ii) Asbestosis
 - (iii) Anthracosis
 - (iv) Anthrax.

Module II

13. (a) Write briefly about the classification of bio hazardous agents. (7 Marks)
- (b) What are the precautionary measures for chemical hazards? (7 Marks)

OR

14. Write short notes on : (14 Marks)
- (i) Vapour (ii) Fog (iii) Dust (iv) Fumes.

Module III

15. Explain effects of radiation on human body and the methods of radioactive waste disposal. (14 Marks)

OR

16. (a) What are the requirements for safe work platform? (7 Marks)
- (b) Discuss about the scaffolding inspections. (7 Marks)

Module IV

17. Describe the effect of air pollution on environment. (14 Marks)

OR

18. Describe the effect of water pollution on environment. (14 Marks)

Module V

19. (a) What are the important points in carrying out workplace inspection? (7 Marks)

(b) What is First aid? Explain CPR. (7 Marks)

OR

20. (a) Explain the first aid measure to be taken during gas poisoning, heart attack, chemical splash and electric shock. (10 Marks)

(b) Briefly explain the elementary first aid. (4 Marks)



CET465	GEOINFORMATICS	CATEGORY	L	T	P	CREDIT	YEAR OF INTRODUCTION
		OEC	2	1	0	3	2019

Preamble: This course introduces students to the basics of geographical information system. They will learn basic concepts in geospatial data handling and analysis. They will learn various steps involved in developing a geographical information system. Course will also explore different use cases of GIS applications.

Prerequisite: NIL

Course Outcomes: After the completion of the course the student will be able to

Course Outcome	Description of Course Outcome	Prescribed learning level
CO1	Explain basic concepts of GIS and spatial data	Understand
CO2	Explain various datatypes and database management	Understand
CO3	Choose various spatial data collection technologies & analysis techniques	Apply
CO4	Demonstrate the use of GIS in various applications	Apply

Mapping of course outcomes with program outcomes (Minimum requirement)

	PO 1	PO 2	PO 3	PO 4	PO 5	PO 6	PO 7	PO 8	PO 9	PO 10	PO 11	PO 12
CO 1	3	-	-	-	3	-	-	-	-	-	-	-
CO 2	3	-	-	-	3	-	-	-	-	-	-	-
CO 3	3	-	-	-	3	-	-	-	-	-	-	-
CO 4	3	-	-	-	3	-	-	-	-	-	-	-

Assessment Pattern

Bloom's Category	Continuous Assessment Tests		End Semester Examination
	1	2	
Remember	10	10	15
Understand	10	10	15
Apply	15	15	35
Analyse	15	15	35
Evaluate			
Create			

Mark distribution

Total Marks	CIE	ESE	ESE Duration
150	50	100	3 hours

Continuous Internal Evaluation Pattern:

Attendance	: 10 marks
Continuous Assessment Test (2 numbers)	: 25 marks
Assignment/Quiz/Course project	: 15 marks

End Semester Examination Pattern: There will be two parts; Part A and Part B. Part A contain 10 questions with 2 questions from each module, having 3 marks for each question. Students should answer all questions. Part B contains 2 questions from each module of which student should answer any one. Each question carries 14 marks and can have maximum 2 sub-divisions.

Course Level Assessment Questions**CO1: Explain basic concepts of GIS and spatial data**

1. What are the basic components of GIS?
2. How datum and projection are important in representing spatial data?
3. What is georeferencing?
4. What are various map elements?

CO2: Explain various datatypes and database management

1. Explain the difference between spatial and attribute data used in GIS.
2. How relational database management systems (RDBMS) are useful?
3. What are the various data models used in GIS?

CO3: Choose various spatial data collection technologies & analysis techniques

1. Layers (or levels) are a fundamental means of organizing geographic data in almost all GIS, why?
2. Explain in detail various spatial data analysis techniques used in GIS.
3. Explain how DEMs are built. What are their applications?
4. What is the use of DGPS?

CO4: Demonstrate on the use of GIS in various applications

1. Discuss with examples how GIS can be useful in disaster management.
2. GIS is a useful tool in environmental science. Discuss?
3. How geospatial information helps in forest management?

Syllabus**Module 1**

Introduction to GIS, History and development of GIS, Spatial data concepts, Coordinate reference systems, datum and projections, map scales, georeferencing, components of GIS, data sources in GIS, data input methods, file formats for GIS, standard GIS packages

Module 2

Type of data, Spatial and attribute data, Data models- vector and raster, Spatial data structure- Vector data structure and raster data structure, Database management systems (DBMS), Relational database management systems (RDBMS)

Module 3

Spatial data analysis, single layer operations- spatial and attribute query, buffer analysis, point pattern analysis, network analysis, surface analysis, interpolation; multi-layer operations- topological overlays, point in polygon, line in polygon, polygon in polygon, logical operators-

AND, OR, NOT, XOR, vector overlay operations-Clip, erase, split, union, identity and intersect; raster calculators; GIS Modeling

Module 4

Digital elevation model (DEM), digital terrain model (DTM), triangular irregular network (TIN)
Global navigation satellite systems- types, Global positioning system- components and principle, satellite ranging- calculating position, GPS errors and biases, Differential GPS (DGPS)

Module 5

Application of GIS in various fields- Urban planning, agriculture, disaster management, forest management, site suitability analysis for infra projects, environmental science, sales and marketing.

A mini project on application of GIS.

Text Books:

1. Anji Reddy, M. Remote Sensing and Geographical Information System, BSP Publications., 2001.
2. Chang, K (2005). Introduction to Geographic Information Systems, Tata McGraw Hills Edition, New Delhi.

References:

1. Geo Information Systems – Applications of GIS and Related Spatial Information Technologies, ASTER Publication Co., Chestern (England), 1992.
2. Burrough P.A., Principles of GIS for Land Resources Assessment, Oxford Publication, 1980.
3. Jeffrey Star and John Estes, Geographical Information System – An Introduction, Prentice – Hall Inc., 1990.
4. Marble D.F., Galkhs H.W. and Pequest, Basic Readings in Geographic Information System, Sped System Ltd., New York, 1984.
5. Clarke, K.C. Parks B.O., and Crane M.P. (2006) Geographic Information systems and environmental modeling- PHI of India, New Delhi.

Course Contents and Lecture Schedule

Module	Topic	Course Outcomes addressed	No. of Lectures
1	Module 1: Total Lecture Hours -7		
1.1	Introduction to GIS, History and development of GIS, Spatial data concepts	CO1	2
1.2	Coordinate reference systems, datum and projections, map scales, georeferencing	CO1	2
1.3	Components of GIS, data sources in GIS	CO1	1
1.4	Data input methods, file formats for GIS, standard GIS packages	CO1	2
2	Module II: Total Lecture Hours- 7		
2.1	Type of data, Spatial and attribute data	CO2	1
2.2	Data models- vector and raster, Spatial data structure- Vector data structure and raster data structure	CO2	3
2.3	Database management systems (DBMS), Relational database management systems (RDBMS)	CO2	3
3	Module III: Total Lecture Hours-7		
3.1	Spatial data analysis, single layer operations- spatial and attribute query, buffer analysis, point pattern analysis, network analysis, surface analysis, interpolation	CO3	3
3.2	multi-layer operations-topological overlays, point in polygon, line in polygon, polygon in polygon, logical operators-AND, OR, NOT, XOR	CO2	2
3.3	Vector overlay operations-Clip, erase, split, union, identity and intersect; raster calculators; GIS Modeling	CO2	2
4	Module IV: Total Lecture Hours- 7		
4.1	Digital elevation model (DEM), digital terrain model (DTM), triangular irregular network (TIN)	CO3	2
4.2	Global navigation satellite systems- types, Global positioning system- components and	CO3	2

	principle		
4.3	Satellite ranging- calculating position, GPS errors and biases	CO3	2
4.4	Differential GPS (DGPS)	CO3	1
5	Module V: Total Lecture Hours- 7		
5.1	Application of GIS in various fields- Urban planning, agriculture, disaster management	CO4	3
5.2	GIS application in forest management, site suitability analysis for infra projects	CO4	2
5.3	GIS application in environmental science, sales and marketing	CO4	2



Model Question Paper

Reg No.: _____

Name: _____

APJ ABDUL KALAM TECHNOLOGICAL UNIVERSITY
SEVENTH SEMESTER B.TECH DEGREE EXAMINATION**Course Code: CET 465****Course Name: GEOINFORMATICS**

Max. Marks: 100

Duration: 3 Hours

Part A*(Answer all questions; each question carries 3 marks)*

1. Explain georeferencing.
2. What is datum?
3. What is attribute data?
4. Raster is faster but vector is corrector. Discuss
5. What is the application of buffer analysis?
6. What is the use of line in polygon overlay?
7. What is TIN?
8. What are the components of a global positioning system?
9. List the data layers needed for identifying a landslide hazard zone?
10. Water quality analysis was carried out on the samples collected from various public wells within a Panchayat. How will you create a water quality map of the Panchayat?

PART B*(Answer one full question from each module, each question carries 14 marks)*

11. (a) Why is it useful to view GIS as a process rather than merely software of hardware? (8 Marks)
- (b) What are the data input methods in GIS? (6 Marks)

OR

12. (a) Explain components of GIS (8 Marks)
- (b) Discuss evolution of GIS. (6 Marks)

13. (a) Explain the difference between attribute and spatial data, give examples (6 Marks)
(d) How relational database management systems (RDBMS) are useful? (8 Marks)

OR

14. (a) Compare vector and raster data models. (8 Marks)
(b) What is a vector data structure? (6 Marks)

15. (a) Explain modelling in GIS with examples. (9 Marks)
(b) What is a raster calculator? (5 Marks)

OR

16. (a) Explain network analysis. How it is useful explain with example. (7 Marks)
(b) Discuss vector overlay operations. (7 Marks)

17. (a) What is DEM? How is it developed? What are its applications? (9 Marks)
(b) Explain the principle of Global positioning. (5 marks)

OR

18. (a) Discuss the possible errors in global positioning and their causes. (7 Marks)
(b) Explain the principle of DGPS. What is its application? (7 Marks)
19. (a) Write a note on importance of geospatial technology in natural hazard management. (7 Marks)
(b) What are the applications of GIS in environmental studies. (7 Marks)

OR

20. (a) Explain the process to develop a GIS for suitability analysis of a reservoir site. (7 Marks)
(b) How sales and marketing is benefitted by GIS? Explain with example. (7 Marks)

2014

APJ ABDUL KALAM
TECHNOLOGICAL
UNIVERSITY

SEMESTER VII

MINOR



CED481	MINI PROJECT	CATEGORY	L	T	P	CREDIT
		PWS	0	0	3	4

Preamble: Mini Project Phase I: A Project topic must be selected either from research literature or the students themselves may propose suitable topics in consultation with their guides. The object of Project Work I is to enable the student to take up investigative study in the broad field of Civil Engineering, either fully theoretical/practical or involving both theoretical and practical work to be assigned by the Department on a group of three/four students, under the guidance of a Supervisor. This is expected to provide a good initiation for the student(s) in R&D work. The assignment to normally include:

- ◆ Survey and study of published literature on the assigned topic;
- ◆ Preparing an Action Plan for conducting the investigation, including team work;
- ◆ Working out a preliminary Approach to the Problem relating to the assigned topic;
- ◆ Block level design documentation
- ◆ Conducting preliminary Analysis/ Modelling/ Simulation/ Experiment/ Design/ Feasibility;
- ◆ Preparing a Written Report on the Study conducted for presentation to the Department;

CO1	Identify and synthesize problems and propose solutions to them.
CO2	Prepare work plan and liaison with the team in completing as per schedule.
CO3	Validate the above solutions by theoretical calculations and through experimental
CO4	Write technical reports and develop proper communication skills.
CO5	Present the data and defend ideas.

Mapping of course outcomes with program outcomes

	PO1	PO2	PO3	PO4	PO5	PO6	PO7	PO8	PO9	PO10	PO11	PO12
CO1	3	3	3	3					3	3		2
CO2	3			3				3	3	3	3	
CO3	3	3	3	3	3					3		
CO4					3			3	3	3		1
CO5	3	3	3	3				3		3	3	1

*1-slight/low mapping, 2- moderate/medium mapping, 3-substantial/high mapping

Assessment Pattern

The End Semester Evaluation (ESE) will be conducted as an internal evaluation based on the product, the report and a viva- voce examination, conducted by a 3-member committee appointed by Head of the Department comprising HoD or a senior faculty member, academic coordinator for that program and project guide/coordinator. The Committee will be evaluating the level of completion and demonstration of functionality/specifications, presentation, oral examination, working knowledge and involvement.

The Continuous Internal Evaluation (CIE) is conducted by evaluating the progress of the mini project through minimum of TWO reviews. At the time of the 1st review, students are supposed to propose a new system/design/idea, after completing a thorough literature study of the existing systems under their chosen area. In the 2nd review students are expected to highlight the implementation details of the proposed solution. The review committee should assess the extent to which the implementation reflects the proposed design. A well coded, assembled and completely functional product is the expected output at this stage. The final CIE mark is the average of 1st and 2nd review marks.

A zeroth review may be conducted before the beginning of the project to give a chance for the students to present their area of interest or problem domain or conduct open brain storming sessions for innovative ideas. Zeroth review will not be a part of the CIE evaluation process.

Marks Distribution

Total Marks	CIE	ESE
150	75	75

Continuous Internal Evaluation Pattern:

Attendance : 10 marks
Marks awarded by Guide : 15 marks
Project Report : 10 marks
Evaluation by the Committee : 40 Marks

End Semester Examination Pattern: The following guidelines should be followed regarding award of marks.

- (a) Demonstration : 50 Marks
- (b) Project report : 10 Marks
- (d) Viva voce : 15marks

Course Plan

In this course, each group consisting of three/four members is expected to design and develop a moderately complex software/hardware system with practical applications. This should be a working model. The basic concept of product design may be taken into consideration.

Students should identify a topic of interest in consultation with Faculty-in-charge of miniproject/Advisor. Review the literature and gather information pertaining to the chosen topic. State the objectives and develop a methodology to achieve the objectives. Carryout the design/fabrication or develop codes/programs to achieve the objectives. Demonstrate the novelty of the project through the results and outputs. The progress of the mini project is evaluated based on a minimum of two reviews.

The review committee may be constituted by the Head of the Department. A project report is required at the end of the semester. The product has to be demonstrated for its full design specifications. Innovative design concepts, reliability considerations, aesthetics/ergonomic aspects taken care of in the project shall be given due weight.



APJ ABDUL KALAM
TECHNOLOGICAL
UNIVERSITY

SEMESTER VII

HONOURS



CET495	MODERN CONSTRUCTION MATERIALS	CATEGORY	L	T	P	CREDIT	YEAR OF INTRODUCTION
		VAC	3	1	0	4	2019

Preamble: Goal of this course is to expose the students to the recent developments in the modern construction materials, and to introduce the conventional construction materials and their modern use. After this course, students will be able to identify and decide the material most suited for the construction, considering the durability, sustainability and economy in the material selection.

Prerequisite: CET309 Construction Technology and Management

Course Outcomes: After completion of the course the student will be able to:

CO 1	Identify and select suitable concrete type for a specific construction
CO 2	Characterize various structural materials for construction
CO 3	Select suitable non-structural materials for buildings
CO 4	Ascertain sustainable materials for construction
CO 5	Outline various smart materials suitable for structures

Mapping of course outcomes with program outcomes (Minimum requirement)

	PO 1	PO 2	PO 3	PO 4	PO 5	PO 6	PO 7	PO 8	PO 9	PO 10	PO 11	PO 12
CO 1	3	1				2	3					3
CO 2	3	1				2	3					3
CO 3	3	1				2	3					3
CO 4	3	1				2	3					3
CO 5	3	1				2	3					3

Assessment Pattern

Bloom's Category	Continuous Assessment Tests		End Semester Examination (Marks)
	Test 1 (Marks)	Test 2 (Marks)	
Remember	20	20	40
Understand	20	20	50
Apply	10	10	10
Analyse			
Evaluate			
Create			

Mark Distribution

Total Marks	CIE Marks	ESE Marks	ESE Duration
150	50	100	3 hours

Continuous Internal Evaluation (CIE) Pattern :

Attendance	: 10 Marks
Continuous Assessment Test (2 numbers)	: 25 Marks
Assignment/Quiz/Course project	: 15 Marks

End Semester Examination (ESE) Pattern : There will be two parts; Part A and Part B. Part A contains 10 questions with 2 questions from each module, having 3 marks for each question. Students should answer all questions. Part B contains 2 questions from each module of which student should answer any one. Each question can have maximum 2 sub-divisions and carry 14 marks.

Course Level Assessment Questions

(Questions may be framed based on the outline given under each course outcome)

Course Outcome 1 (CO1):

1. Explain the mix composition, properties and uses of high strength concrete.
2. Enumerate the various advantages of using high strength concrete.
3. Describe the properties and uses of fibre reinforced concrete.
4. Write a short note on ready mixed concrete. What are its advantages?

Course Outcome 2 (CO2):

1. Explain the types and properties of structural materials
2. Describe the manufacturing process of various structural materials
3. Enumerate the applications of various structural materials in construction

Course Outcome 3 (CO3):

1. Explain the types and properties of non-structural materials
2. Describe the manufacturing process of various non-structural materials
3. Enumerate the uses and applications of various non-structural materials in construction

Course Outcome 4 (CO4):

1. Explain the pros and cons of various sustainable materials
2. Enumerate the uses and applications of various sustainable materials in construction
3. Define the concepts of life cycle assessment

Course Outcome 5 (CO5):

1. Explain the pros and cons of various smart materials
2. Enumerate the applications of smart materials in construction

Syllabus

Module 1 (Advanced Concrete)

Concrete - special concretes for specific purposes like lightweight concrete, ready mixed concrete, high strength concrete, high performance concrete, self compacting concrete, fibre reinforced concrete, polymer concrete, geopolymer concrete, textile reinforced concrete, ferrocement (brief description of composition, properties, and applications of the above).

Module 2 (Structural Materials)

Bricks, fly ash bricks - Stone; Stabilised mud blocks, soil - cement blocks, calcium silicate bricks, red mud - Wood, Industrial Products which can substitute wood ; particle board, fibre board, hard board, Glulam - Polymers; Fibre reinforced polymers - Metals; Steel ; Aluminium - Bituminous materials – Glass, glass reinforced gypsum – Plastics - jute fibre polymer composite (RFPC)

Module 3 (Non-structural Materials)

Properties and use of conventional and modern waterproofing materials, Conventional and modern insulating materials (thermal, sound and electrical insulating materials). Concept of polymer floor finishes, Paints, tiles, Acoustic Treatment, Dry walls, anchors

Module 4 (Sustainable Materials)

Sustainable Construction Materials - Wood, bamboo, straw bales, earthen materials, glass cullet, copper slag, municipal incinerated bottom ash, recycled aggregates, recycled plastic products, sustainable concretes, biocomposites, thatched roofing, linoleum flooring.

Energy - Definition, Types of Unit Energy Values, Assessment of Energy. (brief discussion only)

Introduction to Life Cycle Assessment (brief discussion only)

Module 5 (Smart and Intelligent Materials)

Types- Neoprene, Bridge pads, thermocole- Smart and Intelligent Materials, Special features:- Shape Memory Alloys (SMAs), Magnetostrictive Materials, Piezoelectric Materials, Electrochromic materials, Green materials including biomaterials, biopolymers, bioplastics – Case studies showing the applications of smart and Intelligent Materials.

Text/Reference Books:

1. Building Materials, P. C. Varghese, Prentice-Hall India, 2005.
2. Construction materials: Their nature and behaviour, Eds. J.M. Illston and P.L.J. Domone, 3rd ed., Spon Press, 2001.
3. The Science and Technology of Civil Engineering Materials, J.F. Young, S. Mindess, R.J. Gray & A. Bentur, Prentice Hall, 1998
4. Michel S. Mamlouk and John P. Zaniewski, Materials for Civil and Construction Engineers, Prentice Hall.
5. L. Reed Brantley and Ruth T Brantley, Building Materials Technology, McGraw-Hill Publishers
6. Neil Jackson and Ravindra K. Dhir, Civil Engineering Materials, Palgrave Foundations
7. Don A Watson, Construction Materials and Processes, Career Education
8. Gandhi M. V. and B. S. Thompson, Smart Materials and Structures, Chapman & Hall, London
9. Concrete: Microstructure, properties and materials, P.K. Mehta and P.J.M. Monteiro, McGraw Hill, 2006
10. Properties of concrete, A.M. Neville, Pearson, 2004
11. Shetty M. S., Concrete Technology“, S. Chand & Co., 2006
12. Ganapathy, C., Modern Construction Materials, Eswar Press, 2015.
13. Deucher, K.N, Korfiatis, G.P and Ezeldin, A.S, Materials for civil and Highway Engineers, Prentice Hall Inc., 1998.
14. Mamlouk, M.S. and Zaniewski, J.P., Materials for Civil and Construction Engineers, Prentice Hall Inc., 1999.
15. Brain Culshaw – Smart Structure and Materials Artech House – Borton. London-1996.
16. Materials Science and Engineering, V. Raghavan, Prentice Hall, 1990
17. Sandy Halliday, Sustainable Construction, Butterworth-Heinemann, 2008.

Estd.



2014

Course Contents and Lecture Schedule:

Module	Contents	Outcomes Addressed	Hours
1	Module 1		8
1.1	Review of properties of concrete, uses of concrete	CO1	1
1.2	lightweight concrete (types, properties and uses)	CO1	1
1.3	ready mixed concrete, high strength concrete, high performance concrete	CO1	1
1.4	self compacting concrete (properties, tests and uses)	CO1	2
1.5	fibre reinforced concrete (properties and applications)	CO1	1
1.6	polymer concrete (types, properties and uses)	CO1	1
1.7	geopolymer concrete (brief description of one part and two part geopolymer concrete, composition, properties, and uses)	CO1	1
1.8	textile reinforced concrete (properties and uses), ferrocement (construction, properties and applications)	CO1	1
2	Module 2		9
2.1	Bricks, fly ash bricks	CO2	1
2.2	Stone; Stabilised mud blocks, soil - cement blocks, calcium silicate bricks, red mud	CO2	1
2.3	Wood, Industrial Products which can substitute wood ; particle board, fibre board, hard board, Glulam	CO2	1
2.4	Polymers; Fibre reinforced polymers	CO2	1
2.5	Metals; Steel , Aluminium	CO2	1
2.6	Bituminous materials	CO2	1
2.7	Glass, glass reinforced gypsum	CO2	1
2.8	Plastics	CO2	1
2.9	Jute fibre polymer composite (RFPC)	CO2	1
3	Module 3		9
3.1	Properties and use of conventional and modern waterproofing materials	CO3	1
3.2	Conventional and modern insulating materials (thermal)	CO3	1
3.3	sound and electrical insulating materials	CO3	1
3.4	Concept of polymer floor finishes	CO3	1

3.5	Paints	CO3	1
3.6	Tiles	CO3	1
3.7	Acoustic Treatment	CO3	1
3.8	Dry walls	CO3	1
3.9	Anchors	CO3	1
4	Module 4		9
4.1	Sustainable Construction Materials - Wood, bamboo, straw bales (characteristics, types and uses)	CO4	1
4.2	Earthen materials- rammed earth, earthen bags, mudbrick, adobe, cob, compressed earth block, (characteristics, types and uses)	CO4	1
4.3	Earth shelter technique	CO4	1
4.4	Glass cullet, copper slag, municipal incinerated bottom ash (characteristics and uses)	CO4	1
4.5	Recycled aggregates, recycled plastic products (characteristics, types and uses)	CO4	1
4.6	Sustainable concretes, thatched roofing, linoleum flooring. (characteristics, types and uses)	CO4	1
4.7	Emergy - Definition, Types of Unit Emergy Values	CO4	1
4.8	Assessment of emergy	CO4	1
4.9	Introduction to Life Cycle Assessment (brief discussion)	CO4	1
5	Module 5		9
5.1	Types- Neoprene	CO5	1
5.2	Bridge pads	CO5	1
5.3	Thermocole	CO5	1
5.4	Smart and Intelligent Materials	CO5	1
5.5	Shape Memory Alloys (SMAs), Magnetostrictive Materials	CO5	1
5.6	Piezoelectric Materials, Electrochromic materials	CO5	1
5.7	Green materials including biomaterials, biopolymers, bioplastics	CO5	2
5.8	Case studies showing the applications of smart and Intelligent Materials.	CO5	2

Model Question Paper**QP CODE:****Reg No.:** _____**Name:** _____

APJ ABDUL KALAM TECHNOLOGICAL UNIVERSITY
SEVENTH SEMESTER B.TECH DEGREE EXAMINATION, MONTH & YEAR

Course Code: CET 495**Course Name : MODERN CONSTRUCTION MATERIALS**

Max. Marks: 100

Duration: 3 hours

Part A*(Answer all questions; each question carries 3 marks)*

1. Enumerate the various advantages of using high strength concrete.
2. State the advantages of self compacting concrete.
3. What is the use of gypsum board in construction?
4. Define dressing of stones
5. Name few commercially available water proofing compounds
6. What is meant by façade material?
7. Explain about linoleum flooring and its sustainability aspects.
8. Enlist the pros and cons of bamboo as a construction material
9. List out the recent smart materials used in building construction
10. What is shape memory alloys?

PART B*(Answer one full question from each module, each question carries 14 marks)***Module – 1**

11. (a) Explain the mix composition, properties and uses of self compacting concrete. (8)
(b) Write a short note on ready mixed concrete. What are its advantages? (6)
12. (a) Explain the different types, properties and uses of light weight concrete. (8)
(b) Explain the typical composition of a geopolymer concrete and its advantages. (6)

Module – 2

13. (a) Describe corrosion of steel and the measures adopted for its prevention. (8)
(b) Explain the different types of glass and its applications in buildings. (6)
14. (a) Detail the types of plastics, its manufacturing process and uses. (8)
(b) Explore the possibilities of stabilized mud block as a construction material (6)

Module – 3

15. (a) Explain the functions, types and properties of water proofing compounds. (8)
(b) Critically compare different modern flooring materials. (6)
16. (a) Describe various modern thermal and sound insulating materials. (8)
(b) Compare “breathing” and “non-breathing” types of paints. What are the considerations in application of these paints to the ceiling under the wet areas and wall surfaces? (6)

Module – 4

17. (a) What are the various eco-friendly materials for green building? (8)
(b) Discuss the uses of glass cullet in the construction industry. (6)
18. (a) Explain the uses of copper slag as sustainable aggregate. (6)
(b) How will you improve low-cost rural houses using modern construction materials? (8)

Module – 5

19. (a) Compare Smart and intelligent materials (6)
(b) Explain the various types of smart materials based on their properties (8)
20. (a) Write an explanatory note on the special features and application of intelligent and smart modern materials (8)
(b) Evaluate the effects of smart materials on green buildings (6)

CET497	SOIL DYNAMICS AND MACHINE FOUNDATIONS	CATEGORY	L	T	P	CREDIT	YEAR OF INTRODUCTION
		VAC	3	1	0	4	2019

Preamble: Goal of this course is to impart to the students, in-depth knowledge about the basic concepts and theories of soil dynamics and machine foundation.

Prerequisite: Geotechnical Engineering - II

Course Outcomes: After completion of the course the student will be able to:

CO 1	Analyze single degree of freedom systems under vibration using theory of vibrations
CO 2	Evaluate dynamic soil properties using IS procedures
CO 3	Analyze the response of machine foundations
CO 4	Design machine foundation with reciprocating and Impact type of machines
CO 5	Design of wave barriers

Mapping of course outcomes with program outcomes (Minimum requirement)

	PO 1	PO 2	PO 3	PO 4	PO 5	PO 6	PO 7	PO 8	PO 9	PO 10	PO 11	PO 12
CO 1	3	-	-	3	-	-	-	-	-	-	-	-
CO 2	3	-	-	-	-	-	-	-	-	-	-	-
CO 3	2	3	-	-	-	-	-	-	-	-	-	-
CO 4	2	2	3	-	-	-	-	-	-	-	-	-
CO 5	3	3	-	-	-	-	-	-	-	-	-	-

Mark Distribution

Total Marks	CIE Marks	ESE Marks	ESE Duration
150	50	100	3 hours

Continuous Internal Evaluation (CIE) Pattern :

Attendance	: 10 Marks
Continuous Assessment Test (2 numbers)	: 25 Marks
Assignment/Quiz/Course project	: 15 Marks

End Semester Examination (ESE) Pattern : There will be two parts; Part A and Part B. Part A contains 10 questions with 2 questions from each module, having 3 marks for each question. Students should answer all questions. Part B contains 2 questions from each module of which student should answer any one. Each question can have maximum 2 sub-divisions and carry 14 marks.

Syllabus**Module 1**

Theory of vibrations: Definitions, Single degree freedom system - Free vibration of a spring mass system. Free vibration with viscous damping- Critically damped system, Over damped system, Under damped system. Logarithmic decrement. Forced vibration with damping. Frequency dependent excitation.

Dynamic soil properties: Definition and factors affecting. Determination of dynamic soil properties -Cross hole test, Cyclic plate load test, Block vibration test, Correlations of dynamic soil properties with SPT N value.

Module 2

Analysis of Machine Foundations: Modes of vibrations of a rigid foundation block. Linear Elastic Weightless Spring method of analysis for all modes of vibration- Numerical problems. Concept of elastic Half-space method of analysis.

Module 3

Design of foundation for reciprocating machines: Design of foundations for reciprocating machines (IS method of Design) -design requirements and design procedure for block type foundation-Necessary data, design criteria, permissible amplitude.

Module 4

Design of foundation for Impact type machines-Design criteria and design procedure for block type foundation (IS method). Properties and requirements of cushion pad, Construction criteria of foundations for impact type of machines.

Module 5

Vibration isolation for Machine Foundations: Choice of vibration isolation -IS Guidelines, Active and passive isolation, Transmissibility, Design of wave barriers (open trench), dynamic properties of vibration isolators- coil springs, rubber springs, cork pads, Design procedure for foundations on absorbers .

Text Books:

1. Ranjan G. and A. S. R. Rao, Basic and Applied Soil Mechanics, New Age International, 2002.
2. Arora K. R., Geotechnical Engineering, Standard Publishers, 2006.

References:

1. Das B. M., Principles of Geotechnical Engineering, Cengage India Pvt. Ltd., 2010.
2. Venkatramaiah, Geotechnical Engg, Universities Press, 2000.
3. Terzaghi K. and R. B. Peck, Soil Mechanics in Engineering Practice, John Wiley, 1967.
4. A V Narasimha Rao and C Venkatramaiah, Numerical Problems, Examples and Objective questions in Geotechnical Engineering, Universities Press (India) Ltd., 2000
5. Purushothamaraj P., Soil Mechanics and Foundation Engineering, Dorling Indersley (India) Pvt. Ltd., 2013
6. Taylor D.W., Fundamentals of Soil Mechanics, Asia Publishing House, 1948.

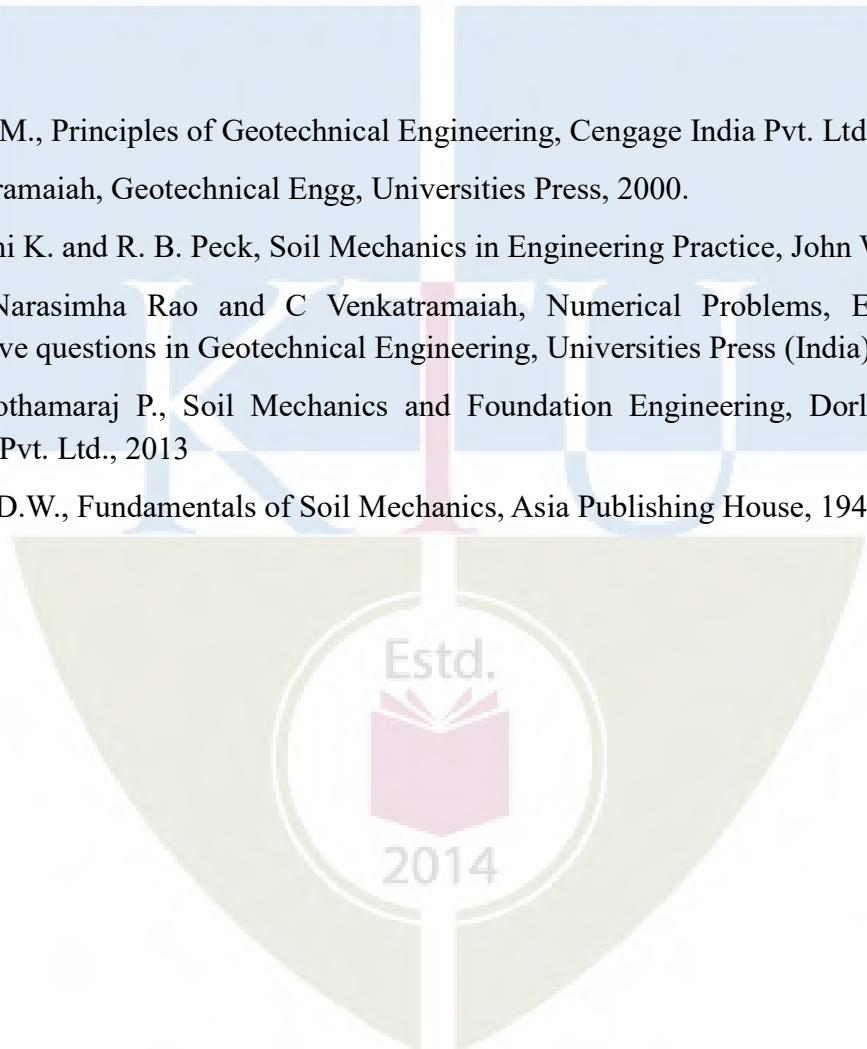

Course Contents and Lecture Schedule

Module	Contents	Hours
1		
1.1	Theory of vibrations: Definitions, Single degree freedom system	1
1.2	Free vibration of a spring mass system.	1
1.3	Free vibration with viscous damping- Critically damped system, Over damped system, Under damped system	1
1.4	Logarithmic decrement. Forced vibration with damping	1
1.5	Frequency dependent excitation.	1
1.6	Dynamic soil properties: Definition and factors affecting	1
1.7	Determination of dynamic soil properties -Cross hole test, Cyclic plate load test, Block vibration test	2
1.8	Correlations of dynamic soil properties with SPT N value.	1
2		
2.1	Analysis of Machine Foundations: Modes of vibrations of a rigid foundation block	1
2.2	Linear Elastic Weightless Spring method of analysis for all modes of vibration	2
2.3	Numerical problems	3
2.4	Concept of elastic Half-space method of analysis.	3
3		
3.1	Design of foundation for reciprocating machines -Design of foundations for reciprocating machines (IS method of Design)	4
3.2	Design requirements	3
3.3	Design procedure for block type foundation-Necessary data, design criteria, permissible amplitude	4
4		
4.1	Design of foundation for Impact type machines -Design criteria and design procedure for block type foundation (IS method)	5
4.2	Properties and requirements of cushion pad	2
4.3	Construction criteria of foundations for impact type of machines.	2

5		
5.1	Vibration isolation for Machine Foundations: Choice of vibration isolation	1
5.2	IS Guidelines	1
5.3	Active and passive isolation, Transmissibility, Design of wave barriers (open trench)	2
5.4	Dynamic properties of vibration isolators- coil springs, rubber springs, cork pads	1
5.5	Design procedure for foundations on absorbers	2



CET499	ENVIRONMENTAL POLLUTION CONTROL TECHNIQUES	CATEGORY	L	T	P	CREDIT	YEAR OF INTRODUCTION
		VAC	3	1	0	4	2019

Preamble: The course is designed to impart knowledge on the fundamental aspects of environmental pollution and its control techniques among students. It helps the learners to understand the sources of environmental pollution, characteristics of pollutants, waste treatment techniques and empower the learners to adopt appropriate strategies to control the environmental pollution.

Pre-requisite: Nil

Course outcome: After the course, the student will able to:

CO1	Explain the basic concepts of Air pollution and Water pollution
CO2	List the environmental protection laws and acts implemented in India to abate the Environmental Pollution
CO3	Describe various treatment techniques used to control the Environmental Pollution
CO4	Differentiate the treatment techniques for domestic sewage and industrial wastewater
CO5	Explain the different practices adopted for solid waste management of a community

Mapping of course outcomes with program outcomes

	PO1	PO2	PO3	PO4	PO5	PO6	PO7	PO8	PO9	PO10	PO11	PO12
CO1	3					2	2					
CO2	3					2	1					
CO3	3					3	2					
CO4	3					2	2					
CO5	3					3	2					

Assessment pattern

Bloom's Category	Continuous Assessment Tests		End Semester Examination (Marks)
	Test 1 (Marks)	Test 2 (Marks)	
Remember	15	15	30
Understand	20	20	40
Apply			
Analyze	15	15	30
Evaluate			
Create			

Continuous Internal Evaluation Pattern: -

Attendance	:	10marks
Continuous Assessment Test (2numbers)	:	25 marks
Assignment/Quiz	:	15marks
Total	:	50 marks

End semester examination pattern – There will be two parts; Part A and Part B. Part A contain 10 questions with 2 questions from each module, having 3 marks for each question. Students should answer all questions. Part B contains 2 questions from each module of which students should answer anyone. Each question can have maximum 2 sub-divisions and carry 14 marks.

Course Level Assessment Questions

Qn. No	Question	Marks	Course outcome (CO) Assessed
Part A(Answer all questions)			
1	What are the different sources of air pollutants?	3	CO1
2	What are the various approaches to minimize exhaust emissions from automobiles?	3	CO1
3	Write a short note on skimming tanks.	3	CO3
4	Give a general layout of a waste treatment plant.	3	CO3

5	Explain the biological characteristics of Industrial wastes.	3	CO4
6	Explain the significance of pre-treatment of industrial waste and briefly describe any one method.	3	CO4
7	What are the drawbacks of incineration?	3	CO5
8	What are the different waste minimization strategies?	3	CO5
9	Enumerate the different environmental rules and regulations in India.	3	CO2
10	What are the different methods for the identification of environmental impacts of a project?	3	CO2
Part B (Answer ANY ONE FULL question from each module)			
Module I			
11	What do you mean by particulate pollutants? Explain the various means to control them.	14	CO1
12	Explain in detail, the different means to control gaseous pollutants	14	CO1
Module II			
13	Explain with a neat sketch, the working of an activated sludge process. State the merits and demerits of the process as well.	14	CO3
14	Explain with a neat sketch, the working of a trickling filter. Also state its merits and demerits.	14	CO3
Module III			
15	Explain High Rate Anaerobic Treatment method for treating industrial wastes.	14	CO4
16	Explain equalization and proportioning for treating industrial wastes.	14	CO4
Module IV			

17	How do the waste matters are stabilized during Sanitary Land Filling? Explain.	14	CO5
18	What is composting? Explain various types of composting.	14	CO5
Module V			
19	Explain Environmental Management Plan.	14	CO2
20	Discuss the different Environmental protection laws and acts in India with respect to Air Pollution.	14	CO2



Syllabus

Module 1 (9hrs)

Introduction to environmental pollution-Air pollution – Sources – Primary pollutants, Secondary pollutants - Criteria pollutants – Effects - Control of gaseous pollutants (adsorption, absorption, reaction and other methods) – Control of particulate pollutants (settling chambers, cyclone separation, Wet collectors, fabric filters, electrostatic precipitators)– Automobile pollution control, Air Pollution Mitigation Measures - Ambient air quality standards.

Module 2 (9hrs)

Water pollution – Sources – Various Pollutants – Effects - Treatment and control methods – Physico-chemical and Biological Treatments – Screening, skimming, sedimentation, coagulation, Filtration, Trickling Filters, Activated sludge process, Oxidation ponds,

Module 3 (9hrs)

Industrial Pollution - Characteristics of industrial wastes: physical, chemical and biological. Pretreatment of industrial wastes: waste volume reduction, waste strength reduction neutralization, equalization and proportioning. High rate anaerobic methods (design not needed). Essential elements of an Environmental Management System (EMS)

Module 4 (9hrs)

Solid waste management: Type and source of solid waste, characteristics, collection, segregation, transportation and processing- Waste minimization strategies – Reduction - Recycling – Reuse; Disposal - composting, sanitary landfill, incineration; Hazardous Waste Treatment and Disposal - Biological and chemical treatment of hazardous wastes, Landfill disposal of hazardous waste; Bioremediation of hazardous waste disposal sites.

Module 5 (8hrs)

Administrative and Legislative control of environmental pollution. Important Environmental rules and regulations, environmental protection acts and rules. Environmental Management Plan, identification and mitigation of environmental impacts.

Text Books

1. Peavy, Rowe, Tchobanoglous, Environmental Engineering, Mc Graw Hill International Editions.
2. M.N. Rao & H.V.N. Rao, Air Pollution, Tata Mc Graw Hill Pvt. Ltd., New Delhi.
3. S. K. Garg, Environmental Engineering Vol. I & II, Khanna Publishers, New Delhi.
4. B.C. Punmia, Waste water Engineering, Arihant Publications, Jodpur.

5. C.S. Rao, Environmental Pollution Control Engineering, New Age International (P)Ltd, New Delhi.

References

1. Nelson Leonard Nemerow, Theories and practices of industrial waste treatment, Addison-Wesley Publishing Co., Inc.
2. W Wesley Eckenfelder Jr., Industrial water pollution control, International Edition, Mc Graw Hill Inc, New Delhi.
3. M Narayana Rao, Waste water treatment, Rational methods of design and Industrial practice, Oxford & IBH Publishing Co. Pvt. Ltd, Bombay.
4. Warren Viessman and mark J Hammer, Water Supply and Pollution Control, Pearson Education, Inc.
5. Gilbert M.Masters, Kurian Joseph and R. Nagendran, Introduction to Environmental Engineering and Science.
6. Ruth F. Weiner and Robin Matthews, Environmental Engineering, Butterworth-Heinemann, Elsevier.

Course content and Schedule of Lecture

Module	Topic	Course outcome addressed	No of Hours
Module I (9 Hours)			
1.1	Introduction to environmental pollution	CO1	1
1.2	Air pollution – Sources – Primary pollutants, Secondary pollutants Criteria pollutants– Effects	CO1	2
1.3	Control of gaseous pollutants	CO1	2
1.4	Control of particulate pollutants	CO1	2
1.5	Automobile pollution control	CO1	1
1.6	Air Pollution Mitigation Measures- Ambient air quality standards.	CO1	1
Module II (9 Hours)			
2.1	Water pollution – Sources – Various Pollutants – Effects	CO3	1

2.2	Physico-chemical and Biological Treatments – Screening, Skimming	CO3	1
2.3	Sedimentation	CO3	1
2.4	Coagulation	CO3	1
2.5	Filtration	CO3	1
2.6	Trickling Filters	CO3	1
2.7	Activated sludge process	CO3	2
2.8	Oxidation ponds	CO3	1
Module III (9 Hours)			
3.1	Industrial Pollution - Characteristics of industrial wastes: physical, chemical and biological	CO4	2
3.2	Pretreatment of industrial wastes: waste volume reduction	CO4	2
3.3	Waste strength reduction neutralization	CO4	1
3.4	Equalization and proportioning, High rate anaerobic methods	CO4	2
3.5	Essential elements of an Environmental Management System (EMS)	CO4	2
Module IV (8 Hours)			
4.1	Solid waste management: Type and source of solid waste, characteristics	CO5	1
4.2	Collection, segregation, transportation and processing	CO5	1
4.3	Waste minimization strategies – Reduction - Recycling – Reuse	CO5	1
4.4	Disposal - composting, sanitary landfill, incineration	CO5	2
4.5	Hazardous Waste Treatment and Disposal	CO5	1
4.6	Biological and chemical treatment of hazardous wastes	CO5	1
4.7	Landfill disposal of hazardous waste	CO5	1
4.8	Bioremediation of hazardous waste disposal sites	CO5	1
Module V (8 Hours)			
5.1	Administrative and Legislative control of environmental pollution	CO2	2
5.2	Important Environmental rules and regulations	CO2	2

5.3	Environmental protection acts and rules	CO2	2
5.4	Environmental Management Plan, identification and mitigation of environmental impacts	CO2	2

Model Question Paper

Reg.No.:..... QP CODE:.....

Name:.....

APJ ABDUL KALAM TECHNOLOGICAL UNIVERSITY**SEVENTH SEMESTER B.TECH DEGREE EXAMINATION, MONTH & YEAR****Course Code: CET 499****Environmental Pollution Control Techniques****Max. Marks: 100****Duration: 3 hours****Part A****(Answer all questions; each question carries 3 marks)**

1. What are the different sources of air pollutants?
2. What are the various approaches to minimize exhaust emissions from automobiles?
3. Write a short note on skimming tanks.
4. Give a general layout of a waste treatment plant.
5. Explain the biological characteristics of Industrial wastes.
6. Explain the significance of pre-treatment of industrial waste and briefly describe any one method.
7. What are the drawbacks of incineration?
8. What are the different waste minimization strategies?
9. Enumerate the different environmental rules and regulations in India. Explain the significance of pre-treatment of industrial waste and briefly describe any one method.
10. What are the different methods for the identification of environmental impacts of a project?

Part B**(Answer any one question from each module; each question carries 14 marks)****MODULE 1**

11. What do you mean by particulate pollutants? Explain the various means to control control them.

OR

12. Explain in detail, the different means to control gaseous pollutants.

MODULE 2

13. Explain with a neat sketch, the working of an activated sludge process. State the merits and demerits of the process as well.

OR

14. Explain with a neat sketch, the working of a trickling filter. Also state its merits and demerits.

MODULE 3

15. Explain High Rate Anaerobic Treatment method for treating industrial wastes.

OR

16. Explain Equalisation and Proportioning for treating industrial wastes.

MODULE 4

17. How do the waste matters are stabilized during Sanitary Land Filling? Explain.

OR

18. What is composting? Explain various types of composting.

MODULE 5

19. Explain Environmental Management Plan.

OR

20. Discuss the different Environmental protection laws and acts in India with respect to air pollution.

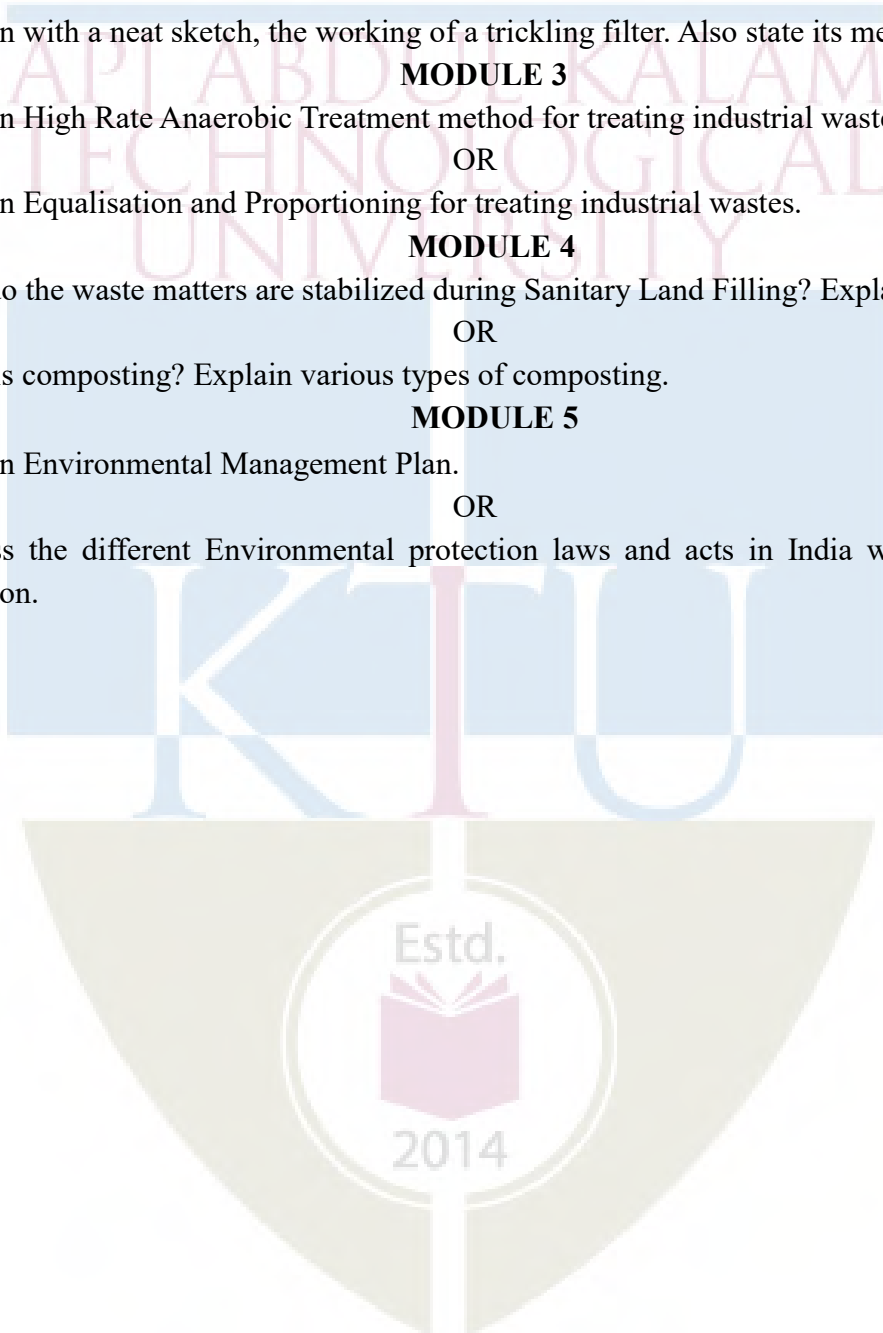

APJ ABDUL KALAM
TECHNOLOGICAL
UNIVERSITY

SEMESTER VIII

KTU



Assessment Pattern

Bloom's Category	Continuous Assessment Tests		End Semester Examination
	1	2	
Remember	10		10
Understand	10	10	30
Apply	30	40	60
Analyse			
Evaluate			
Create			

Mark distribution

Total Marks	CIE	ESE	ESE Duration
150	50	100	3 hours

Continuous Internal Evaluation Pattern:

Attendance : 10marks
 Continuous Assessment Test(2numbers) : 25 marks
 Assignment/Quiz/Course project : 15marks

End Semester Examination Pattern: There will be two parts; Part A and Part B.

Part A contain 3 questions from Module-I & II. Answer any 2 question, each question carries 10 marks.

Part B contains 3 questions from Module III of which student should answer any 2 questions. Each full question carries 25 marks.

Part C contains 3 questions from Module IV of which student should answer any 2 questions. Each question carries 15 marks.

Note:

For analysis of rate and cost estimation, unit rate and labour requirement should be given along with the questions in the question paper. No other charts, tables, codes are permitted in the Examination Hall. If necessary, relevant data shall be given along with the question paper.

Sample Course Level Assessment Questions

CO1: Define basic terms related to estimation, quantity surveying and contract document

1.	What is mean by the term (a) Work charge establishment (b) Provisional quantity
2.	List different type of estimate. Explain any two in detail.

CO2: Interpret the item of work from drawings and explain its general specification and unit of measurement.

1	Give the units of following work (a) Carpentry fitting (b) Pointing (c) Plastering
2	Explain the general rule of measurement as per Indian Standards

CO3: Make use of given data from CPWD DAR/DSR for calculating the unit rate of different items of work associated with building construction

1.	<p>Develop rate analysis for DSR item No.5.3, Reinforced cement concrete work with 1:1.5:3 (3 graded stone aggregate 20 mm nominal size) in beams, suspended floors, roofs having slope up to 15° landings, above plinth level up to floor five level, excluding the cost of centering, shuttering, finishing and reinforcement.</p> <p>Material : 20mm Aggregate $0.57\text{m}^3 @ ₹1300/\text{m}^3$, 10mm $0.28\text{m}^3 @ ₹1300/\text{m}^3$, coarse sand (Zone III) $0.425\text{m}^3 @ ₹1200/\text{m}^3$, Portland cement $400\text{kg} @ ₹5700/\text{tonne}$.</p> <p>Labour : Mason $0.24 @ ₹467/\text{day}$, Beldar $2.75 @ ₹368/\text{day}$, Bhisti $0.90 @ ₹407/\text{day}$, Coolie $1.88 @ ₹368/\text{day}$</p> <p>Carriage provisions : Stone aggregate below 40mm $0.85\text{m}^3 @ ₹103.77$, Portland cement $0.40\text{tonne} @ ₹5700/\text{tonne}$.</p> <p>Hire Charges for concrete mixer $0.08 @ ₹800/\text{day}$, Vibrator needle type $₹0.08 @ 350/\text{day}$</p> <p>Sundries (LS) $14.30 @ ₹1.73$. Adopt water charges, contractor profit and overheads as per the CPWD DSR2018 provisions.</p>
----	---

CO4: Develop detailed measurement (including BBS) and BoQ of a various work like buildings, earthwork for road, sanitary and water supply work

1.	List the any four items of work in plumbing work of residential building
2.	Write the unit of measurement of (i) Carpentry fittings (ii) Pointing of Brick Wall
3.	Prepare a bar bending schedule and quantities of RCC and reinforcement of a simply supported beam of length 6.5 m , depth 50 cm, and width 30 cm reinforced with 3 Nos of 20 mm dia at bottom as straight bar, 2 Nos of 20 mm dia cranked at 45o , 2 Nos 16 Φ at top of beam and 8 mm Φ 2 legged stirrups @ 15 cm c/c
4.	<p>Prepare detailed measurement for the following items of work for the construction of residential building shown below using Centre line method</p> <p>(a) RRM for foundation (75cm x 75cm) and basement 50cm x 50cm , Wall thickness 20cm</p> <p>(b) Brick work for superstructure</p> <p>(c) RCC works for slab (12cm thick), lintel (15cm thick), and sun shade (60cm projection)</p> <p>(d) Painting for walls, doors(D1-100x210; D2 80x210) and windows (W2-100x150; W3-150x150;KW1-50x100;KW2-100x100); V(90x60).</p> <div style="text-align: center;"> </div> <p>Also Calculate No. of brick, cement & sand required for Brick wall</p>

CO5: Explain various basic terms related to valuation of land and building

1.	Explain how depreciation in building is worked out.
----	---

2.	Discuss about the different types of values and the term obsolescence
3	Discuss the importance of valuation in civil engineering.
4	Differentiate the terms Value, Cost and Price

CO6: Develop valuation of buildings using different methods of valuation.

1.	A building is situated by the side of a main road of Mumbai city on a land of 500sq m. The built up portion is 20m x 15 m. The building is first class type and provided with water supply, sanitary and electrical fittings, and the age of the building is 30 years. Workout the valuation of the property.
2.	Workout the valuation of a commercial building with the following data: Cost of land for life-time period of building is ₹.5,20,000/-. Gross income per year is ₹.8,50,000/-Expenses required per year: (a) staff salary, electric charges, municipal taxes including licenses fees, stationery and printing etc. is 20% of the gross income. (b) For repair and maintenance of lift, furniture etc. @ 5% of their capital cost of ₹.10,50,000/- (c) sinking fund for the items considered in capital cost, whose life is 25years @4% after allowing 10% scrap value. (d) Insurance premium is ₹.25,000/- per year. Take year's purchase @8% and annual repair of the building @2% on gross income.

Syllabus

MODULE 1.

Introduction- Quantity Surveying- Basic principles, Role/responsibility of Quantity surveyor at various stages of construction

Estimate-Details required, Type of estimate, purposes.

Contingencies, Work-charge establishment, Tools and Plant, centage charge, Day work, Prime cost, Provisional sum & provisional Quantity, Overhead charges, Cost index, Contract documents (Brief description only)

Bill of Quantity -Typical format-use

Item of works- Identify various item of work from the drawings-units of measurement of various materials and works (focus may give to RCC residential building)

General rule & method of measurement with reference to Indian Standard Specifications- IS1200.

MODULE 2.

Introduction to the use of CPWD schedule of rates as per latest DSR and Analysis of rate as per latest DAR

Specifications–General specification of all items of a residential building.

Detailed specification (CPWD specifications) of major item of work like Earth work excavation in foundation, masonry, Reinforced cement concrete, finishing of building work

Analysis of rates for Earth work in excavation for foundation, mortars, reinforced cement concrete Works, finishing work, masonry work, stone works, flooring with reference to latest DSR and latest DAR (Data should be given).

MODULE 3.

Detailed Estimate- Preparation of detailed measurement using Centre line method & Short wall long wall (separate wall) method for RCC single storied building (Flat roof) including stair cabin- Residential/office/school building.

BOQ preparation of a single storied RCC building work.

Material quantity calculation of the items of work (Rubble, Brick work, Concrete work, Plastering) in detailed estimate prepared for building work. (Data for unit quantity should be provided from DAR)

Bar Bending Schedule- Preparation of BBS of RCC beams, slabs, Column footings, Retaining wall.

Road estimation-Estimation of earthwork from longitudinal section-metalled road.

Estimation of sanitary and water supply work -Water tank, Septic tank, Manhole (*No Detailed estimate needed-concept of item of work, its general specification and unit of measurement*).

MODULE 4.

Valuation – purpose, factor affecting, introduction to terms-Value, Cost, Price, kinds of values
Income- Gross income, net income, outgoings, annuity, sinking fund, Year's purchase, Depreciation, obsolescence -Free hold and leasehold properties.

Methods of calculating depreciation – straight line method – constant percentage method, sinking fund method and quantity survey method.

Methods of valuation– rental method, direct comparison of capital cost, valuation based on profit, depreciation method.

Various method of valuation of land (Brief description only)

Text Books:

1. B. N. Dutta, Estimation and costing in civil engineering, UBS publishers
2. Rangwala, Estimation Costing and Valuation, Charotar publishing house pvt. ltd
3. Dr. S. Seetha Raman, M.Chinna swami, Estimation and quantity surveying, Anuradha publications Chennai.
4. M Chakraborty, Estimating, Costing, Specification and valuation, published by the author, 21 B, Babanda Road, Calcutta 26

References:

1. B S Patil, Civil Engineering contracts and estimates, university press
2. V N Vazirani & S P Chandola, Civil Engineering Estimation and Costing, Khanna Publishers
3. IS 1200-1968; Methods of measurement of building & civil engineering works
4. CPWD DAR 2018 and DSR 2018 or latest
5. CPWD Specifications Vol1 & 2 (2019 or latest edition)

Course Contents and Lecture Schedule

Module	Topic	Course Outcomes addressed	No. of Lectures
1	Module I: Total lecture hours:8		
1.1	Introduction to Quantity survey, basic principle, Role/responsibility of Quantity surveyor, Estimate-List the types, Details required	CO1	1
1.2	Types of estimates, simple problems of approximate estimate, purpose	CO1	1
1.3	Contingencies, Work-charge establishment, Tools and Plant, centage charge, Day work, Prime cost, Provisional sum & provisional Quantity (Brief description only)	CO1	1
1.4	Bill of Quantity -Typical format-use	CO2	1

1.5	Units of measurement of various materials and works	CO2	2
1.6	General rule & method of measurement with reference to Indian Standard Specifications-IS1200	CO2	1
1.7	Introduction to the use of CPWD schedule of rates as per latest DSR and Analysis of rate as per latest DAR, Overhead charges, Cost index.	CO2	1
2	Module II: Total lecture hours-5		
2.1	Specifications-General specification of various items of building work.	CO3	1
2.2	Detailed specification of major item of work like Earth work excavation in foundation, masonry, Reinforced cement concrete, finishing of building work with reference to CPWD specifications	CO3	2
2.3	Analysis of rates for Earth work in excavation for foundation, mortars, reinforced cement concrete Works, finishing work, masonry work, stone works, flooring with reference to latest DSR and latest DAR (All data (Material, labour & machine) and rate will be given in the question paper)	CO3	2
3	Module III: Total lecture hours: 16		
3.1	Preparation of detailed measurement and abstract of estimate using Centre line method & Short wall long wall (separate wall) method- Explain with a single room building example	CO4	2
3.2	Preparation of detailed measurement for RCC single storey buildings with stair cabin- Excavation for foundation, Foundation and basement, DPC, Masonry in superstructure, RCC, Plastering, Painting, flooring, Woodwork, Staircase.	CO4	5
3.3	Preparation of BoQ of single storied RCC building	CO4	1
3.4	Material quantity calculation of the Rubble, Brick work, Concrete work, plastering in detailed	CO4	1

	estimate of RCC building (Data for unit quantity should be provided from DAR)		
3.5	BBS of RCC beams, slabs, Column footings, Retaining wall	CO4	4
3.6	Road estimation-Estimation of earthwork from longitudinal section-metalead road	CO4	2
3.7	Estimation of sanitary and water supply work - Water tank, Septic tank , Manhole (Concept only)	CO4	1
4	Module IV: Total lecture hours: 7		
4.1	Valuation –Purpose, factor affecting- Introduction to terms-Value, Cost, Price, Income- Gross income, net income, outgoings, annuity, sinking fund (Simple Examples), Year’s purchase, Depreciation, obsolescence -Free hold and leasehold properties.	CO5	2
4.2	Depreciation – methods of calculating depreciation – straight line method, constant percentage method, sinking fund method, and quantity survey method-numerical examples	CO6	2
4.4	Methods of valuation of land with building – rental method, direct comparison of capital cost, valuation based on profit, depreciation method.	CO6	2
4.5	Various method of valuation of land (Brief description only)	CO6	1

Model Question Paper

Reg.No.: _____

Name: _____

APJ ABDUL KALAM TECHNOLOGICAL UNIVERSITY**EIGHTH SEMESTER B. TECH DEGREE EXAMINATION****Course Code: CET402****Course Name: QUANTITY SURVEYING AND VALUATION**

Max.Marks:100

Duration: 3Hours

*General Instructions: 1. Supplement answers with illustrations, wherever necessary.**2. Assume any missing data and state the assumptions clearly. Assumptions should be realistic.***PART A***Answer Two full question**(10×2 marks = 20 marks)***Module 1 & II**

1. a. Explain the terms (a) Cost index (b) Overhead charges (4)
b. List different type of Estimate. Explain the detailed estimate (8)
2. a. What are different types of specification? (2)
b. Reproduce the detailed specification for earthwork excavation for foundation (8)
3. Develop unit rate of the work (DSR 2018 item No. 4.1.2), providing and laying in position 1:1½:3 (1 Cement: 1½ coarse sand (zone-III) : 3 graded stone aggregate 20 mm nominal size) cement concrete of specified grade excluding the cost of centering and shuttering - All work up to plinth level : MATERIAL : 0.57cu.m 20mm nominal size of stone aggregate @ Rs.1370/cu.m., 0.28cu.m 10mm nominal size of stone aggregate @ Rs.1350/cu.m., 0.425 cu.m of coarse sand (Zone-III) @Rs.1350/cu.m., 0.2833cu.m Portland cement @ Rs.4940/tonne, LABOUR : 0.10 Mason @ Rs.709/day; 1.63 Beldar @ Rs.558/day, 0.70 Bhisti @ Rs.617/day. CARRIAGE PROVISIONS: Stone aggregate below 40mm Rs. 103.77/cu.m.; coarse sand @Rs.103.77/cu.m. and for cement @ Rs.92.24/tonne. HIRE CHARGES of concrete mixer 0.07@Rs.800/day, Vibrator 0.07@Rs.370/day, SUNDRIES , LS, 14.30@Rs.2 (10)

PART B*Answer Two full question**(2 x 25=50 Marks)*

Module III

4. Prepare Schedule of bars and calculate the quantities of material required for constructing a retaining wall shown in figure. Length of retaining wall 20m.

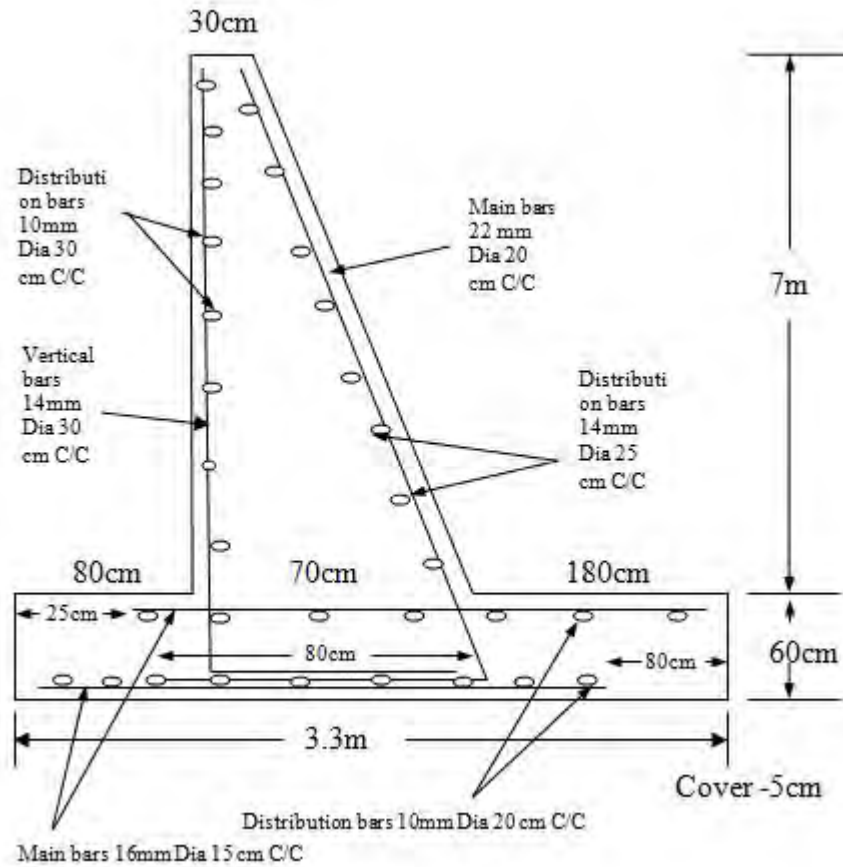

5. Calculate the following quantity of the given plan using Centre line method. Assume suitable dimensions for Doors & Windows
(Door D1 -100x210; D2 -80x210; W2 -120x140; V1- 90x60; KW2- 120x90; FW1- 60x180)
- Earth work excavation, Width of base Concrete 75cm
 - Foundation (60cm x 60cm) and basement (45cm x 45cm) with RR masonry
 - Brick work for super structures, CM1:6
 - RCC 1:2:4 for roof
 - Wood work for door and windows

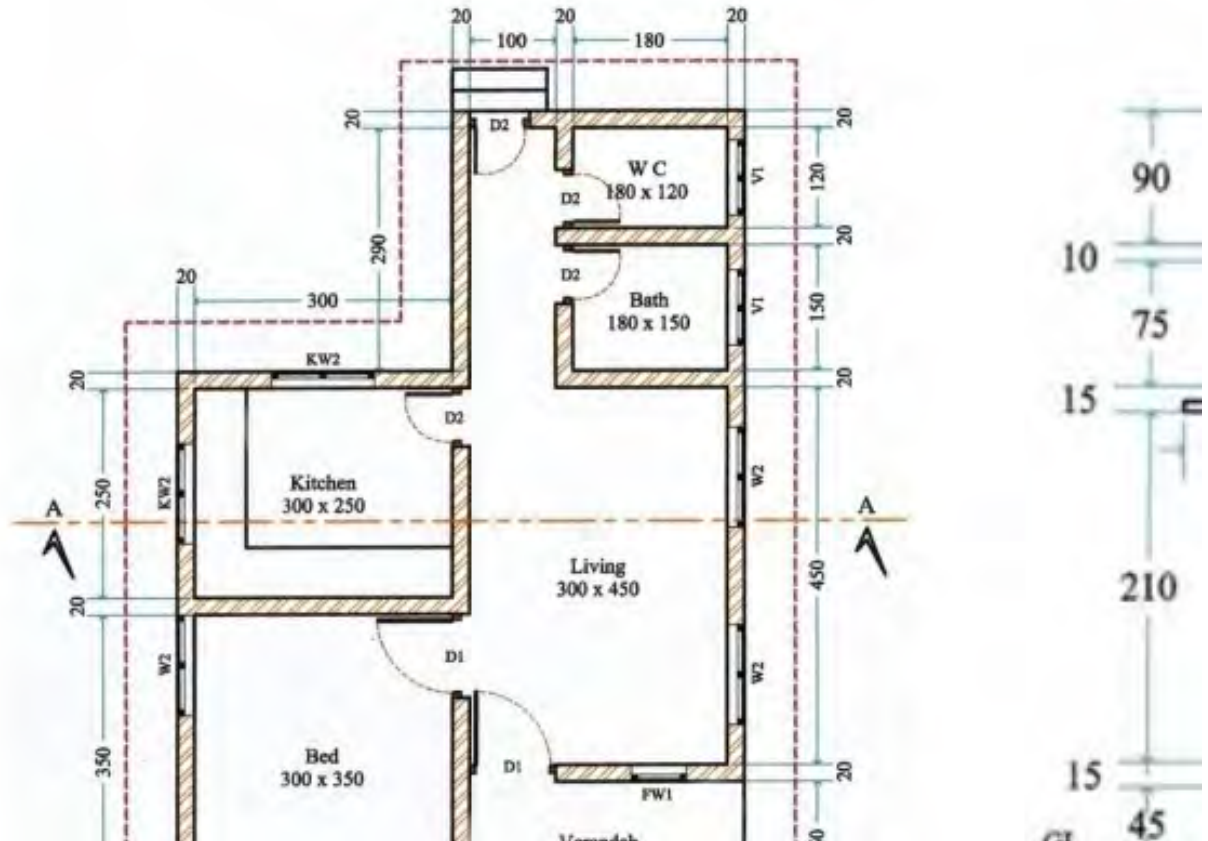

6. **a.** A simply supported beam of size 450 x 230 having a span of 6m is supported on a 30cm wall at both ends. The stirrups of 10mm diameter are provided at a spacing of 150mm c/c. The beam have main bar of 3 no's 20mm diameter at bottom including one bend up bar and stirrup holders are of 2 no's 16mm diameter at top. Main & Stirrup holder reinforcement is provided with a cover of 25mm. Calculate the total quantity of the reinforcement required for the stirrup for this beam. Also prepare an estimate of tor steel reinforcement for stirrup including cutting, bending , placing in position and binding, adopt the rate as Rs.95/kg. (10 Marks)
- b.** Calculate the quantity of earth work for a portion of road of length 700m. Formation width of road is 8m, side slope in banking 2: 1 and 1:1 in cutting, road has a down gradient of 1 in 150, formation level 160 at distance 0.

Distance (m)	0	100	200	300	400	500	€
Reduced	158.9	159.10	159.20	162.20	160.80	160.70	1

(15 Marks)

PART C

*Answer Two full question**(2 x 15=30 Marks)*

7. **a.** A concrete mixer was purchased at Rs.8000/-. Assuming salvage value to be Rs.1000, after 5 years, calculate depreciation for each year adopting (a) Straight line method (b) Constant percentage method and (c) Sinking fund method considering 6% interest. (8 marks)
- b.** A lease-hold property is to produce a net income of Rs.12,000/- per annum for the next - 60 years. What is the value of the property? Assume that the land lord desires a return of 6% on his capital and the sinking fund to replace the capital is also to accumulate at 6%. What will be the value of the property if the rate of interest for redemption of capital is 3%? (7 marks)
8. **a.** Explain various method of land valuation (8 marks)
- b.** Workout the valuation of a commercial building with the following data: Cost of land for life-time period of building is ₹.5,20,000/-. Gross income per year is ₹.8,50,000/- Expenses required per year: (a) staff salary, electric charges, municipal taxes including licenses fees, stationery and printing etc. is 20% of the gross income. (b) For repair and maintenance of lift, furniture etc. @ 5% of their capital cost of ₹.10,50,000/- (c) sinking fund for the items considered in capital cost, whose life is 25 years @4% after allowing 10% scrap value. (d) Insurance premium is ₹.25,000/- per year. Take year's purchase @8% and annual repair of the building @2% on gross income. (8 marks)
9. **a.** List the factors affecting valuation. (5 marks)
- b.** Explain the significance of sinking fund, How it is calculated. (5 marks)
- c.** A person purchased a property for Rs.50,00,000/-. Assuming its salvage value after 40 years will be Rs. 5,00,000/-, determine amount of depreciation each year considering it to be uniform. (5 marks)

CET404	COMPREHENSIVE COURSE VIVA	CATEGORY	L	T	P	CREDIT
		PCC	1	0	0	1

Preamble: The objective of this Course viva is to ensure the basic knowledge of each student in the most fundamental core courses in the curriculum. The viva voce shall be conducted based on the core subjects studied from third to eighth semester. This course helps the learner to become competent in placement tests and other competitive examinations.

Guidelines

1. The course should be mapped with a faculty and classes shall be arranged for practicing questions based on the core courses listed in the curriculum.
2. The viva voce will be conducted by the same three member committee assigned for final project phase II evaluation. It comprises of Project coordinator, expert from Industry/research Institute and a senior faculty from a sister department.
3. The pass minimum for this course is 25.
4. The mark will be treated as internal and should be uploaded along with internal marks of other courses.
5. Comprehensive Viva should be conducted along with final project evaluation by the three member committee.

Mark Distribution

Total marks: 50, only CIE, minimum required to pass : 25 Marks



CED416	PROJECT PHASE II	CATEGORY	L	T	P	CREDIT
		PWS	0	0	12	4

Preamble: The course ‘Project Work’ is mainly intended to evoke the innovation and invention skills in a student. The course will provide an opportunity to synthesize and apply the knowledge and analytical skills learned, to be developed as a prototype or simulation. The project extends to 2 semesters and will be evaluated in the 7th and 8th semester separately, based on the achieved objectives. One third of the project credits shall be completed in 7th semester and two third in 8th semester. It is recommended that the projects may be finalized in the thrust areas of the respective engineering stream or as interdisciplinary projects. Importance should be given to address societal problems and developing indigenous technologies.

Course Objectives

- To apply engineering knowledge in practical problem solving.
- To foster innovation in design of products, processes or systems.
- To develop creative thinking in finding viable solutions to engineering problems.

Course Outcomes [COs]: After successful completion of the course, the students will be able to:

CO1	Model and solve real world problems by applying knowledge across domains (Cognitive knowledge level: Apply).
CO2	Develop products, processes or technologies for sustainable and socially relevant applications (Cognitive knowledge level: Apply).
CO3	Function effectively as an individual and as a leader in diverse teams and to comprehend and execute designated tasks (Cognitive knowledge level: Apply).
CO4	Plan and execute tasks utilizing available resources within timelines, following ethical and professional norms (Cognitive knowledge level: Apply).
CO5	Identify technology/research gaps and propose innovative/creative solutions (Cognitive knowledge level: Analyze).
CO6	Organize and communicate technical and scientific findings effectively in written and oral forms (Cognitive knowledge level: Apply).

Mapping of course outcomes with program outcomes

	PO1	PO2	PO3	PO4	PO5	PO6	PO7	PO8	PO9	PO10	PO11	PO12
CO1	2	2	2	1	2	2	2	1	1	1	1	2
CO2	2	2	2		1	3	3	1	1		1	1
CO3									3	2	2	1
CO4					2			3	2	2	3	2
CO5	2	3	3	1	2							1
CO6					2			2	2	3	1	1

Abstract POs defined by National Board of Accreditation			
PO #	Broad PO	PO#	Broad PO
PO1	Engineering Knowledge	PO7	Environment and Sustainability
PO2	Problem Analysis	PO8	Ethics
PO3	Design/Development of solutions	PO9	Individual and team work
PO4	Conduct investigations of complex problems	PO0	Communication
PO5	Modern tool usage	PO11	Project Management and Finance
PO6	The Engineer and Society	PO12	Lifelong learning

PROJECT PHASE II

Phase 2 Targets

- In depth study of the topic assigned in the light of the report prepared under Phase - I;
- Review and finalization of the approach to the problem relating to the assigned topic.
- Preparing a detailed action plan for conducting the investigation, including teamwork.
- Detailed Analysis/ Modeling / Simulation/ Design/ Problem Solving/Experiment as needed.
- Final development of product/ process, testing, results, conclusions and future directions.
- Preparing a paper for Conference Presentation/ Publication in Journals, if possible.
- Presenting projects in Project Expos conducted by the University at the cluster level and/ or state level as well as others conducted in India and abroad.
- Filing Intellectual Property Rights (IPR) if applicable.
- Preparing a report in the standard format for being evaluated by the Department Assessment Board.
- Final project presentation and viva voce by the assessment board including the external expert.

Evaluation Guidelines & Rubrics

Total: 150 marks (Minimum required to pass: 75 marks).

- Project progress evaluation by guide: 30 Marks.
- Two interim evaluations by the Evaluation Committee: 50 Marks (25 marks for each evaluation).
- Final evaluation by the Final Evaluation committee: 40 Marks
- Quality of the report evaluated by the evaluation committee: 30 Marks

(The evaluation committee comprises HoD or a senior faculty member, Project coordinator and project supervisor. The final evaluation committee comprises of Project coordinator, expert from Industry/research/academic Institute and a senior faculty from a sister department).

Evaluation by the Guide

The guide/supervisor must monitor the progress being carried out by the project groups on regular basis. In case it is found that progress is unsatisfactory it should be reported to the Department Evaluation Committee for necessary action. The presence of each student in the group and their involvement in all stages of execution of the project shall be ensured by the guide. Project evaluation by the guide: 30 Marks. This mark shall be awarded to the students in his/her group by considering the following aspects:

Project Scheduling & Distribution of Work among Team members: Detailed and extensive Scheduling with timelines provided for each phase of project. Work breakdown structure well defined. (5)

Literature survey: Outstanding investigation in all aspects. (4)

Student's Diary/ Daily Log: The main purpose of writing daily diary is to cultivate the habit of documenting and to encourage the students to search for details. It develops the students' thought process and reasoning abilities. The students should record in the daily/weekly activity diary the day to day account of the observations, impressions, information gathered and suggestions given, if any. It should contain the sketches & drawings related to the observations made by the students. The daily/weekly activity diary shall be signed after every day/week by the guide. (7)

Individual Contribution: The contribution of each student at various stages. (9)

Completion of the project: The students should demonstrate the project to their respective guide. The guide shall verify the results and see that the objectives are met. (5)



EVALUATION RUBRICS for PROJECT Phase II: Interim Evaluation - 1

No.	Parameters	Marks	Poor	Fair	Very Good	Outstanding
2-a	Novelty of idea, and Implementation scope [CO5] [Group Evaluation]	5	The project is not addressing any useful requirement. The idea is evolved into a non-implementable one. The work presented so far is lacking any amount of original work by the team.	Some of the aspects of the proposed idea can be implemented. There is still lack of originality in the work done so far by the team. The project is a regularly done theme/topic without any freshness in terms of specifications, features, and/or improvements.	Good evidence of an implementable project. There is some evidence for the originality of the work done by the team . There is fresh specifications/features/improvements suggested by the team. The team is doing a design from fundamental principles, and there is some independent learning and engineering ingenuity.	The project has evolved into incorporating an outstandingly novel idea. Original work which is not yet reported anywhere else. Evidence for ingenious way of innovation which is also Implementable. Could be a patentable / publishable work.
			(0 – 1 Marks)	(2 – 3 Marks)	(4 Marks)	(5 Marks)
2-b	Effectiveness of task distribution among team members. [CO3] [Group Evaluation]	5	No task distribution of any kind. Members are still having no clue on what to do.	Task allocation done, but not effectively, some members do not have any idea of the tasks assigned. Some of the tasks were identified but not followed individually well.	Good evidence of task allocation being done, supported by project journal entries, identification of tasks through discussion etc. However, the task distribution seems to be skewed, and depends a few members heavily than others. Mostly the tasks are being followed by the individual members.	Excellent display of task identification and distribution backed by documentary evidence of team brainstorming, and project journal entries. All members are allocated tasks according to their capabilities, and as much as possible in an equal manner. The individual members are following the tasks in an excellent manner.
			(0 – 1 Marks)	(2 – 3 Marks)	(4 Marks)	(5 Marks)
2-c	Adherence to project schedule. [CO4] [Group Evaluation]	5	Little or no evidence of continued planning or scheduling of the project. The students did not stick to the plan what they were going to build nor plan on what materials / resources to use in the project. The students do not have any idea on the budget required even after the end of phase - I. No project journal kept or the journal.	There is some improvement in the primary plan prepared during phase I. There were some ideas on the materials /resources required, but not really thought out. The students have some idea on the finances required, but they have not formalized a budget plan. Schedules were not prepared. The project journal has no useful details on the project.	Good evidence of planning done and being followed up to a good extent after phase I. Materials were listed and thought out, but the plan wasn't followed completely. Schedules were prepared, but not detailed, and needs improvement. Project journal is presented but it is neither complete nor updated regularly.	Excellent evidence of enterprising and extensive project planning and follow-up since phase I. Continued use of project management/version control tool to track the project. Material procurement if applicable is progressing well. Tasks are updated and incorporated in the schedule. A well-kept project journal showed evidence for all the above, in addition to the interaction with the project guide.
			(0 - 1 Marks)	(2 - 3 Marks)	(4 Marks)	(5 Marks)

2-d	Interim Results. [CO6] [Group assessment]	5	There are no interim results to show.	The team showed some interim results, but they are not complete / consistent to the current stage, Some corrections are needed.	The interim results showed were good and mostly consistent/correct with respect to the current stage. There is room for improvement.	There were significant interim results presented which clearly shows the progress.
			(0 - 1 Marks)	(2 - 3 Marks)	(4 Marks)	(5 Marks)
2-e	Presentation [Individual assessment]	5	Very poor presentation and there is no interim results. The student has no idea about the project proposal.	Presentation is average, and the student has only a feeble idea about the team work.	Good presentation. Student has good idea about the team's project. The overall presentation quality is good.	Exceptionally good presentation. Student has excellent grasp of the project. The quality of presentation is outstanding.
			(0 - 1 Marks)	(2 - 3 Marks)	(4 Marks)	(5 Marks)
Phase-II Interim Evaluation - 1 Total Marks: 25						



EVALUATION RUBRICS for PROJECT Phase II: Interim Evaluation – 2

No	Parameters	Marks	Poor	Fair	Very Good	Outstanding
2-f	Application of engineering knowledge [CO1] [Individual Assessment]	10	The student does not show any evidence of applying engineering knowledge on the design and the methodology adopted. The student's contribution in application of engineering knowledge in the project is poor.	The student appears to apply some basic knowledge, but not able to show the design procedure and the methodologies adopted in a comprehensive manner.	The student is able to show some evidence of application of engineering knowledge in the design and development of the project to good extent.	Excellent knowledge in design procedure and its adaptation. The student is able to apply knowledge from engineering domains to the problem and develop solutions.
			(0 – 3 Marks)	(4 – 6 Marks)	(7 - 9 Marks)	(10 Marks)
2-g	Involvement of individual members [CO3] [Individual Assessment]	5	No evidence of any Individual participation in the project work.	There is evidence for some amount of individual contribution, but is limited to some of the superficial tasks.	The individual contribution is evident. The student has good amount of involvement in core activities of the project.	Evidence available for the student acting as the core technical lead and has excellent contribution to the project.
			(0 - 1 Marks)	(2 - 3 Marks)	(4 Marks)	(5 Marks)
2-h	Results and inferences upon execution [CO5] [Group Assessment]	5	None of the expected outcomes are achieved yet. The team is unable to derive any inferences on the failures/ issues observed. Any kind of observations or studies are not made.	Only a few of the expected outcomes are achieved. A few inferences are made on the observed failures/issues. No further work suggested.	Many of the expected outcomes are achieved. Many observations and inferences are made, and attempts to identify the issues are done. Some suggestions are made for further work.	Most of the stated outcomes are met. Extensive studies are done and inferences drawn. Most of the failures are addressed and solutions suggested. Clear and valid suggestions made for further work.
			(0 - 1 Marks)	(2 - 3 Marks)	(4 Marks)	(5 Marks)
2-i	Documentation and presentation. [CO6] [Individual assessment]	5	The individual student has no idea on the presentation of his/her part. The presentation is of poor quality.	Presentation's overall quality needs to be improved.	The individual's presentation performance is satisfactory.	The individual's presentation is done professionally and with great clarity. The individual's performance is excellent.
			(0 - 1 Marks)	(2 - 3 Marks)	(4 Marks)	(5 Marks)

Phase-II Interim Evaluation - 2 Total Marks: 25

EVALUATION RUBRICS for PROJECT Phase II: Final Evaluation

No	Parameters	Marks	Poor	Fair	Very Good	Outstanding
2-j	Engineering knowledge. [CO1] [Group Assessment]	10	The team does not show any evidence of applying engineering knowledge on the design and the methodology adopted.	The team is able to show some of the design procedure and the methodologies adopted, but not in a comprehensive manner.	The team is able to show evidence of application of engineering knowledge in the design and development of the project to good extent. There is scope for improvement.	Excellent knowledge in design procedure and its adaptation. The team is able to apply knowledge from engineering domains to the problem and develop an excellent solution.
			(0 – 3 Marks)	(4 – 6 Marks)	(7 - 9 Marks)	(10 Marks)
2-k	Relevance of the project with respect to societal and/or industrial needs. [Group Assessment] [CO2]	5	The project as a whole do not have any societal / industrial relevance at all.	The project has some relevance with respect to social and/or industrial application. The team has however made not much effort to explore further and make it better.	The project is relevant to the society and/or industry. The team is mostly successful in translating the problem into an engineering specification and managed to solve much of it.	The project is exceptionally relevant to society and/or industry. The team has made outstanding contribution while solving the problem in a professional and/or ethical manner.
			(0 - 1 Marks)	(2 - 3 Marks)	(4 Marks)	(5 Marks)
2-i	Innovation / novelty / Creativity [CO5] [Group Assessment]	5	The project is not addressing any useful requirement. The idea is evolved into a non-implementable one. The work presented so far is lacking any amount of original work by the team.	Some of the aspects of the proposed idea appears to be practical. There is still lack of originality in the work done. The project is a regularly done theme/topic without any freshness in terms of specifications, features, and/or improvements.	Good evidence of an implementable project. There is some evidence for the originality of the work done by the team. There is fresh specifications/features/improvements suggested by the team. The team is doing a design from fundamental principles, and there is some independent learning and engineering ingenuity. Could be translated into a product / process if more work is done.	The project has evolved into incorporating an outstandingly novel idea. Original work which is not yet reported anywhere else. Evidence for ingenious way of innovation which is also Implementable. Could be a patentable publishable work.
			(0 - 1 Marks)	(2 - 3 Marks)	(4 Marks)	(5 Marks)
2-m	Quality of results / conclusions / solutions. [CO1] [Group Assessment]	10	None of the expected outcomes are achieved. The team is unable to derive any inferences on the failures/issues observed. Any kind of observations or studies is not made.	Only a few of the expected outcomes are achieved. A few inferences are made on the observed failures/issues. No further work suggested.	Many of the expected outcomes are achieved. Many observations and inferences are made, and attempts to identify the issues are done. Some suggestions are made for further work.	Most of the stated outcomes are met. Extensive studies are done and inferences drawn. Most of the failures are addressed and solutions suggested. Clear and valid suggestions made for further work.
			(0 – 3 Marks)	(4 – 6 Marks)	(7 - 9 Marks)	(10 Marks)

2-n	Presentation - Part I Preparation of slides. [CO6] [Group Assessment].	5	The presentation slides are shallow and in a clumsy format. It does not follow proper organization.	Presentation slides follow professional style formats to some extent. However, its organization is not very good. Language needs to be improved. All references are not cited properly, or acknowledged. Presentation slides needs to be more professional.	Presentation slides follow a good style format and there are only a few issues. Organization of the slides is good. Most of references are cited properly. The flow is good and team presentation is neatly organized. Some of the results are not clearly shown. There is room for improvement.	The presentation slides are exceptionally good. Neatly organized. All references cited properly. Diagrams/Figures, Tables and equations are properly numbered, and listed. Results/ inferences clearly highlighted and readable.
			(0 - 1 Marks)	(2 - 3 Marks)	(4 Marks)	(5 Marks)
	Presentation - Part II: Individual Communication [CO6] [Individual Assessment].	5	The student is not communicating properly. Poor response to questions.	The student is able to explain some of the content. The student requires a lot of prompts to get to the idea. There are language issues.	Good presentation/ communication by the student. The student is able to explain most of the content very well. There are however, a few areas where the student shows lack of preparation. Language is better.	Clear and concise communication exhibited by the student. The presentation is outstanding. Very confident and tackles all the questions without hesitation. Exceptional traits of communicator.
			(0 - 1 Marks)	(2 - 3 Marks)	(4 Marks)	(5 Marks)
Phase-II Final Evaluation, Marks: 40						



EVALUATION RUBRICS for PROJECT Phase II: Report Evaluation

Sl. No.	Parameters	Marks	Poor	Fair	Very Good	Outstanding
2-o	Report [CO6]	30	The prepared report is shallow and not as per standard format. It does not follow proper organization. Contains mostly unacknowledged content. Lack of effort in preparation is evident. References are not cited. Unprofessional and inconsistent formatting.	Project report follows the standard format to some extent. However, its organization is not very good. Language needs to be improved. All references are not cited properly in the report. There is lack of formatting consistency.	Project report shows evidence of systematic documentation. Report is mostly following the standard style format and there are only a few issues. Organization of the report is good. Mostly consistently formatted. Most of references/sources are cited, acknowledged properly.	The report is exceptionally good. Neatly organized. All references cited properly. Diagrams/Figures, Tables and equations are properly numbered, and listed and clearly shown. Language is excellent and follows professional styles. Consistent formatting and exceptional readability.
			(0 - 11 Marks)	(12 - 18 Marks)	(19 - 28 Marks)	(29 - 30 Marks)
Phase - II Project Report Marks: 30						

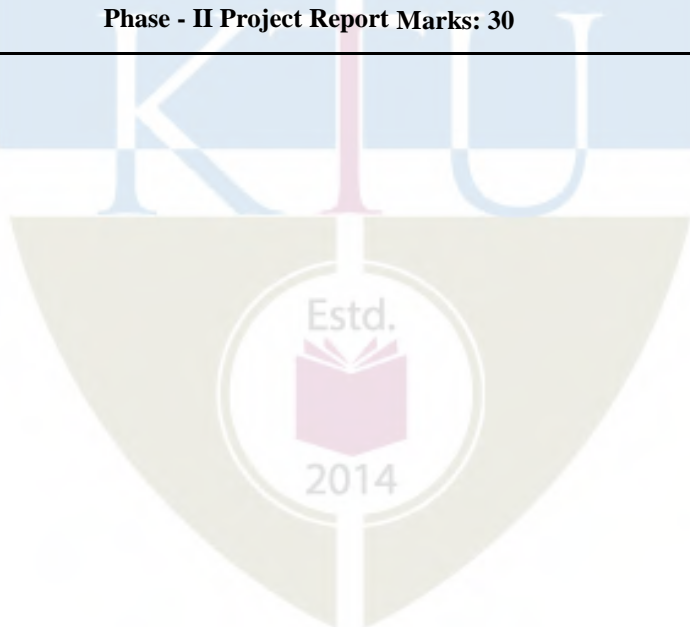

APJ ABDUL KALAM
TECHNOLOGICAL
UNIVERSITY

SEMESTER VIII

PROGRAM ELECTIVE III



CET414	ADVANCED STRUCTURAL DESIGN	CATEGORY	L	T	P	CREDIT	YEAR OF INTRODUCTION
		PEC	3	0	0	3	2019

Preamble: This course intends to brush-up the fundamentals of design of reinforced concrete and steel structures by limit state design and review the usage of relevant codes. The course offers to make students competent by covering contemporary engineering practices in the structural design. This course is also intended to develop the mixed qualities to students in structural engineering point of view - independently handling the design problems and to work in a group for team works (through assignments)

Prerequisite: CET303 Design of Concrete Structures, CET401 Design of Steel Structures

Course Outcomes: After the completion of the course the student will be able to

Course Outcome	Description of Course Outcome	Prescribed learning level
CO1	Design and detail cantilever retaining wall and understand the design principles of Counter fort retaining wall. And Design and detail deep beams	Applying Understanding
CO2	Design and detail water tanks as per IS code provisions	Applying
CO3	Explain Concept of yield line theory and design of different slab using yield line theory Design of Flat slabs using IS code provisions.	Understanding Applying
CO4	Analyse and design Cold form light gauge section.	Applying
CO5	Use of latest industry standard formula, table, design aids used for design of beams and portal frames under pattern loading.	Understanding Applying

Mapping of course outcomes with program outcomes (Minimum requirement)

	PO1	PO2	PO3	PO4	PO5	PO6	PO7	PO8	PO9	PO10	PO11	PO12
CO1	2	-	1	-	-	1	-	-	-	1	-	-
CO2	3	1	1	-	-	-	-	-	-	1	-	-
CO3	3	2	3	-	-	-	-	-	-	1	-	-
CO4	3	2	3	-	-	-	-	-	-	1	-	-
CO5	1	3	2	-	-	-	-	2	2	1	-	1

Assessment Pattern

Bloom's Category	Continuous Assessment Tests		End Semester Examination
	1	2	
Remember	5	5	10
Understand	10	10	20
Apply	25	25	50
Analyse	5	5	10
Evaluate	5	5	10
Create			

Mark distribution

Total Marks	CIE	ESE	ESE Duration
150	50	100	3 hours

Continuous Internal Evaluation Pattern:

Attendance	: 10 marks
Continuous Assessment Test (2 numbers)	: 25 marks
Assignment/Quiz/Course project	: 15 marks

End Semester Examination Pattern: There will be two parts; Part A and Part B. Part A contain 10 questions with 2 questions from each module, having 3 marks for each question. Students should answer all questions. Part B contains 2 questions from each module of which student should answer any one. Each question carries 14 marks and can have maximum 2 subdivisions.

Course Level Assessment (Sample) Questions

CO1: Design and detail cantilever retaining wall and understand the design principles of Counter fort retaining wall. And Design and detail deep beams

1. Identify the situations in which each type of retaining wall is used.
2. Design a cantilever retaining wall has to retain earth 3.5 m high above ground level. The density of earth is 17 KN/m^3 and its angle of repose is 30° . The earth is horizontal at top. The safe bearing capacity of soil is 180 KN/m^2 and coefficient of friction between soil and concrete is 0.55

3. Describe the structural behavior of deep beam.
4. Design a typical interior span of a continuous deep beam using the following data:
 Span of beam = 9m
 Overall depth = 4.5m
 Width of supports = 0.9m
 Width of beam = 0.4m
 Uniformly distributed load (including self weight) = 200kN/m
 Concrete = M20 grade
 Reinforcements = Fe415 HYSD bars
 Sketch the details of reinforcements at centre of span and support sections.
- 5 Explain the design principles of cantilever retaining wall.

CO2: Design and detail water tanks as per IS code provisions.

1. Design a circular water tank with flexible base for a capacity of 450 KL. The depth of water is 4.5 m. Allow suitable free board
2. What are the methods of design of water tanks?
3. Design a rectangular water tank on the ground having size 10m x 4 m x 5 m. Use M30 concrete and Fe 416 steel

CO3: Explain the Concept of yield lines and design of slab using yield lines

Design of Flat slabs using IS code provisions

1. Obtain an expression for the moment carrying capacity along a yield line for isotropically reinforced square slab simply supported and uniformly loaded.
2. Discuss the following: i) Applications of flat slab ii) Components of flat slab
3. Explain the assumptions of yield line theory?
4. Discuss the yield line pattern of one way and two way slab
5. Explain in detail the steps for designing of a flat slab?
1. A RCC slab 5 m. x 5 m. in plan is simply supported along its four edges, and is reinforced with 10 mm. dia. Fe-415 grade bars at 150 mm. c/c both ways. Slab is 130 mm. thick, with average effective depth of reinforcement as 100 mm. slab carries a floor finish weighing 2.0 kN/m.² M-20 concrete is used. Compute the service load. on slab, from fundamentals, of yield line theory. Take load factor = 1.50.
2. Calculate the moments on column strip and middle strip of an interior panel of a flat slab for an office floor to suit the following data. Size of office floor – 25m x 25m
 Size of panel – 5m x 5m
 Loading class – 4 kN/m²
 Use M20 grade concrete and Fe415 HYSD bars.

CO4: Analyse and design Cold form light gauge section.

1. Mention where light gauge members are commonly used
2. Explain typical light gauge steel sections with the help of neat sketches
3. Differentiate behaviour of laterally supported and laterally unsupported beams
4. Explain the behaviour of stiffened and un-stiffened compression elements made up of light gauge sections
5. Two channel sections 200mm x 80mm with bent up lips are connected with webs to act as beam as shown. The thickness of the plate is 2.5mm and depth of lip is 25mm. The beam has an effective span of 4m. Determine the allowable load per meter on the beam. Take $f_y=235$ MPa and $E=200$ Gpa.
6. Explain briefly about design step for a light gauge steel beam with laterally supported system.

CO5: Use latest industry standard formula, table, design aids used for design of beams and portal frames under pattern loading.

1. Design a continuous beam of two spans supported on stone masonry walls using the limit state method and allowing 15% redistribution of moments. The following data may be assumed.
 Clear span between the supports = 6m
 Width of masonry supports = 330mm
 Thickness of RC slab = 150mm
 Spacing of continuous beams = 3m c/c
 Self weight of floor finish = 0.4 kN/m^2
 LL on the floor = 4 kN/m^2
 Characteristic cube strength of concrete = $f_{ck} = 20 \text{ N/mm}^2$
 Characteristic strength of steel = $f_y = 415 \text{ N/mm}^2$
 Also sketch the reinforcement details .
2. Explain the portal method and cantilever method of building frame analysis. Discuss the merits and demerits.
3. What are substitute frames
4. Explain the salient features to be notes in the detailing of reinforcement for portal frames.
5. Design a typical interior portal frame of a hall 10 m wide. The frames are at 4.5 m c/c, with hase fixed. Single storey frame is of height 4.0 m. Slab thickness = 120 mm. Live Load = 2.5 kN/m^2 . Sketch the detailing of slab, beam and column.
6. Sketch a beam Column joint showing the detailing of reinforcements.
7. Discuss the concept of moment redistribution in continuous beams.

Syllabus

Module I

Retaining Structures- Introduction- Functions and types of retaining walls- Structural analysis and design of RCC cantilever type of retaining wall for various types of backfill conditions

Counterfort retaining wall- design principles of components and detailing (design not required)

Structural design of deep beams

Module II

Review of the IS code 3370 (2009)

Introduction to design of water tanks-design philosophy and requirements-joints- IS code recommendations- Design of rectangular water tanks using IS code coefficients (IS 3370-2009).

Design of circular water tanks using IS code coefficients (IS 3370-2009)

Module III

Yield line method of analysis of slabs:- Characteristic features of yield lines- analysis by virtual work method - Yield line analysis by equilibrium method

Flat slabs - Introduction-components-IS Code recommendations- IS code method of design of interior panel (with and without column drop).

Module IV

Review of the codes -IS 811(1987), IS 801(1975),SP 6-5(1980)

Light gauge sections - Types of cross sections - Local buckling and post buckling - Design of compression and Tension members - Design of flexural member-Types of connections and their design

Module V

Design of continuous beams- Redistribution of moments- Detailing

Reinforced concrete portal frames: Introduction - Analysis and design of rectangular portal frames for vertical loading

Approximate methods for structural Analysis and design for vertical loads , Pattern loading, lateral loads

Text Book:

1. Punmia, B. C, Jain A.K and, Jain A.K , R C C Designs, Laxmi Publications Ltd., 10e, 2015
2. Ramchandra S and Virendra Gehlot, Design of Steel Structures Vol. I, Standard Book House, 2007

3. N. Krishna Raju Advanced Reinforced Concrete Design (IS : 456-2000), 2e CBS Publishers & Distributors, 2008.

References:

1. Pillai S.U & Menon D – Reinforced Concrete Design, Tata McGraw Hill Book Co., 2009
2. Varghese P.C, Advanced Reinforced Concrete Design, Prentice Hall of India Pvt Ltd, 2008
3. J. Rhodes and R.M. Lawson "Design of Structures using Cold Formed Steel Sections, SCI Publication 089, The Steel Construction Institute, U.K. 1992
4. Relevant IS codes (IS 456, IS 875, IS 1893, IS 13920, SP 16, SP 34, IS 801)
5. N. Subramanian, Design of Steel Structures, Oxford University Press

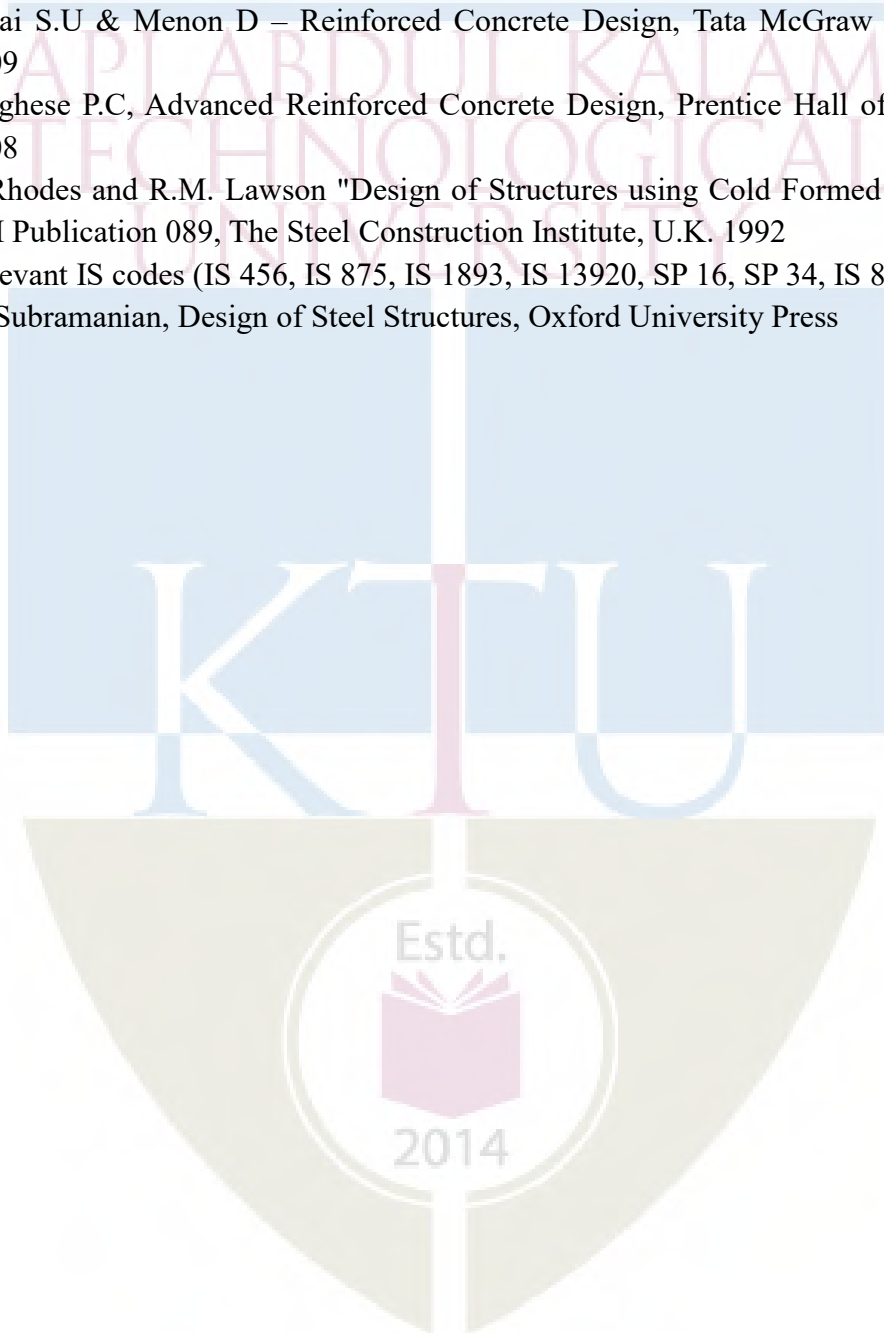

Course Contents and Lecture Schedule

Module	Topic	Course Outcomes addressed	No. of Lectures
1	Module I : Total lecture hours : 6		
1.1	Retaining Structures: Introduction, Functions and types of retaining walls	CO1	1
1.2	Analysis of RCC cantilever type of retaining	CO1	1
1.3	Design of RCC cantilever type of retaining wall for various types of backfill conditions	CO1	2
1.4	Counterfort retaining wall- design principles of components and detailing	CO1	1
1.5	Design of deep beams	CO1	1
2	Module II : Total lecture hours : 6		
2.1	Introduction to design of water tanks-design philosophy	CO2	1
2.2	IS code recommendations	CO2	1
2.3	Design of rectangular water tanks using IS code coefficients (IS 3370)	CO2	2
2.4	Design of circular water tanks using- IS code coefficients (IS 3370)	CO2	2
3	Module III : Total lecture hours : 7		
3.1	Introduction to Yield line method of analysis of slabs:- Characteristic features of yield lines	CO3	1
3.2	Analysis by virtual work method.	CO3	1
3.3	Yield line analysis by equilibrium method	CO3	1
3.4	Design of flat slabs:- Introduction-components	CO3	1
3.5	IS Code recommendations	CO3	1
3.6	IS code method of design of interior panel without drop	CO3	1
3.7	IS code method of design of interior panel with drop	CO3	1
4	Module IV : Total lecture hours : 7		
4.4	Introduction of light gauge sections – Types of cross sections	CO4	1
4.5	Local buckling and post buckling of light gauge sections	CO4	1
4.6	Design of compression and Tension members,	CO4	2

4.7	Design of flexural member	CO4	1
4.8	Types of connections and their design procedure	CO4	2
5	Module V : Total lecture hours : 9		
5.1	Design of continuous beams	CO5	2
5.2	Redistribution of moments.	CO5	1
5.3	Introduction to Reinforced concrete portal frames	CO5	1
5.4	Analysis and design of rectangular portal frames for vertical loading	CO5	1
5.5	Multi-storeyed building frames: Analysis and design due to vertical loads Substitute Frame method of analysis may be followed Use of SP 16 (only Group assignments intended)	CO5	2
5.6	Multi-storeyed building frames- Analysis and design by portal method for lateral loading cantilever method and factor method (only Group assignments intended)	CO5	2



Model Question Paper

Reg. No.: _____

Name: _____

APJ ABDUL KALAM TECHNOLOGICAL UNIVERSITY**EIGHTH SEMESTER B.TECH DEGREE EXAMINATION****Course Code: CET414****Course Name: ADVANCED STRUCTURAL DESIGN**

Max. Marks: 100

Duration: 3 Hours

PART A*Answer all questions; each question carries 3 marks.*

1. a) Explain under what circumstances the counterfort retaining wall is preferred?
- b) Explain the arrangement of reinforcements in a simply supported deep beam across the depth
- c) Draw the cross section of water tank showing reinforcement details.
- d) Explain the applications of drop walls.
- e) Explain the characteristic features of yield line.
- f) State the advantages and disadvantages of flat slab.
- g) What are the advantages of cold formed steel structural members over hot rolled members
- h) Explain post buckling in light gauge steel members
- i) Explain the portal method of building frame analysis.
- j) Explain the effects of pattern loading on frames'

(10×3 marks = 30 marks)**PART B***Answer one full question from each module; each full question carries 14 marks.***Module I**

2. A cantilever retaining wall is designed to retain earth for a height of 4.5 m. The safe bearing capacity of soil is 180 kN/m^2 and unit weight of soil is 17.8 kN/m^3 . Coefficient of friction between soil and concrete is 0.6. Proportion the retaining wall and check for stability. Also design and detail the stem slab of the retaining wall. **(14 marks)**
3. Design a typical interior span of a deep beam using the following data
Span of beam - 8m, overall depth = 4m, width of support= 0.8m., width of beam – 0.4 m
The udl including self-weight acting on the beam is 180kN/m. Sketch the reinforcement details. Use M20 concrete and Fe415 steel. **(14 marks)**

Module II

4. Design and detail a circular tank for a capacity of 500000 litres. The depth of water is to be 5m including freeboard of 30cm. The tank is supported on ground. Design using M20 concrete and 415 grade steel. **(14 marks)**
5. Design a rectangular water tank 5 m x 4 m with depth of storage 3m, resting on ground and whose walls are rigidly joined at vertical and Base. Free at top. Assume M20 concrete and Fe415 grade steel. Sketch the details of reinforcement in the tank using IS Code method. **(14 marks)**

Module III

6. Design an interior panel of a flat slab with panel size 6m x 6m by providing drop. The size of columns is 500 x 500 mm and live load on the panel is 4 kN/m² Use M20 grade concrete and Fe415 steel. **(14 marks)**
7. (a) Discuss the assumptions in yield line method of analysis. **(4 marks)**
- (b) Obtain an expression for the moment carrying capacity along a yield line for an isotropic reinforced square slab simply supported and uniformly loaded. **(9 marks)**

Module IV

8. (a) Explain the behaviour of stiffened and un-stiffened compression elements made up of light gauge sections. **(4 marks)**
- b) A square box section 200x200x2mm is to be used as a column of effective length 4m. Find the maximum load it can carry. **(10 marks)**
9. a) Explain briefly about design step for a light gauge steel beam with laterally supported system. **(4 marks)**
- (b) Explain the following with sketches with reference to light gauge sections: (i) Stiffened and unstiffened compression elements, (ii) flat-width ratio, (iii) effective design width, (iv) torsional flexural buckling, (v) point symmetric section. **(10 marks)**

Module V

10. Design a continuous beam with 2 equal spans of 6m each. The beam being supported on masonry walls of 300mm thickness. Beams are placed at 3m clc, to support a floor of self weight of 3.5 kN/m and supporting a live load of 4 kN/m². (Redistribution 15 % moment) **(14 marks)**
11. Design a portal frame hinged at base assuming M20 grade concrete and Fe415 HYSD bars

to suit the following data.- Spacing of portal frame – 4 m, Height of columns – 4m, Live load on roof – 1.5kN/m^2 , Distance between column centres – 10 m. RCC slab is continuous over portal frame. **(14 marks)**



CET424	GEOENVIRONMENTAL ENGINEERING	CATEGORY	L	T	P	CREDIT	YEAR OF INTRODUCTION
		PEC	3	0	0	3	2019

Preamble: The course introduces the geotechnical engineering need to deal with environmental problems related to the reduction of waste, waste disposal facilities and cleanup of contaminated sites. This course is a blend of geotechnical engineering and environmental concepts and introduces multidisciplinary problem domains. The course aims to develop knowledge in landfill facility design.

Prerequisite: Geotechnical Engineering-I, Environmental Engineering

Course Outcomes: After the completion of the course the student will be able to

Course Outcome	Description of Course Outcome
CO1	Outline the geo-environmental considerations of waste containment
CO2	Explain the contaminant transport mechanism
CO3	Choose the suitable system for waste containment and its various components
CO4	Plan suitable remediation method for contaminated site

Mapping of course outcomes with program outcomes (Minimum requirement)

	PO1	PO2	PO3	PO4	PO5	PO6	PO7	PO8	PO9	PO10	PO11	PO12
CO1	2	-	-	-	-	-	-	-	-	-	-	-
CO2	2	-	-	-	-	-	-	-	-	-	-	-
CO3	3	3	2	-	-	-	-	-	-	-	-	-
CO4	3	2	1	-	-	-	-	-	-	-	-	-

Assessment Pattern

Bloom's Category	Continuous Assessment Tests		End Semester Examination
	1	2	
Remember	10	10	20
Understand	20	10	30
Apply	20	30	50
Analyse			
Evaluate			
Create			

Mark distribution

Total Marks	CIE	ESE	ESE Duration
150	50	100	3 hours

Continuous Internal Evaluation Pattern:

Attendance : 10marks

Continuous Assessment Test(2numbers) : 25 marks

Assignment/Quiz/Course project : 15marks

End Semester Examination Pattern: There will be two parts; Part A and Part B.

Part A contain 10 questions with 2 questions from each module having 3 marks for each question. Students should answer all questions.

Part B contains 2 questions from each Module of which student should answer any one question form each Module. Each question should have a maximum if two subdivision and carry 14marks.

Syllabus**MODULE 1.**

Scope of geo-environmental engineering - multiphase behavior of soil – role of soil in geo-environmental applications – importance of soil physics, soil chemistry, hydrogeology, biological process – impact of ground contamination on geo-environment

Regulatory requirement -Solid waste management rules (brief introduction only) -MoeF guideline

Geochemistry-Geochemical Attenuation-Quantification of attenuation capacities-Laboratory evaluation, sequential batch-contact testing & Column percolation testing. Waste Characteristics of Municipal solid waste-Physical-Chemical & geotechnical

Identification of Hazardous and Non-Hazardous waste

MODULE 2.

Contaminant transport-Transport process- Advection, Diffusion, Dispersion – Advection-Dispersion equation-Fick's equation.

Soil-water-contaminant interaction soil-water interaction and concepts of double layer

Evolution of waste containment facilities and disposal practices – Site selection based on environmental impact assessment –different role of soil in waste containment - Hydrological consideration in land fill design

MODULE 3.

Containment technology, Landfill-Type-site selection

Landfill Components: Landfill layout and capacity, components of landfill and its functions. Types and functions of liner-natural clay liner- compacted clay liner- selection of soil for liner, properties-effect of compaction on permeability of clay.

Geo membrane liners-Types-geosynthetics clay liners , Type- methodology of construction, testing and design aspects.

MODULE 4.

Primary and secondary leachate collection and removal systems.

Drainage, Collection, Removal and Filtration considerations of primary and secondary leachate collection and removal system. Various components and design considerations.

Cover system-Basic concept, Components-surface layer, Protection layer, Drainage layer, Barrier layer Assessment, Gas Management, Gas extraction systems-passive and active system

Closure and post closure monitoring system (brief introduction)

MODULE 5.

Site characterization – risk assessment of contaminated site - remediation methods for soil and groundwater – selection and planning of remediation methods –in-situ / exit remediation, bio remediation, thermal remediation, pump and treat method, phyto remediation and electro-kinetic remediation

Stability of landfill (brief introduction), Soil exploration at contaminated site (brief introduction)

Text Books/ References:

1. Daniel, D.E. (1993). Geotechnical Practice for Waste Disposal. Chapman, and Hall, London.
2. Koerner, R.M. (2005). Designing with Geosynthetics. Fifth Edition. Prentice Hall, New Jersey.
3. Reddi L.N and Inyang HI (2000) Geoenvironmental Engineering: Principles and Applications, Marcel Dekker Inc Publication
4. R. N. Yong (2000) Geoenvironmental Engineering: Contaminated Soils, Pollutant Fate, Mitigation Lewis Publication.

5. Dr. G V Rao and Dr. R S Sasidhar (2009) Solid waste Management and Engineered Landfills, Saimaster Geoenvironmental Services Pvt. Ltd. Publication.
6. Ayyar TSR (2000) Soil engineering in relation to environment, LBS centre for Science and Technology, Trivandrum.
7. Hari D. Sharma, Krishna R. Reddy (2004) Geoenvironmental Engineering: Site Remediation, Waste Containment, and Emerging Waste Management Technologies, Publisher: John Wiley & Sons Inc.
8. Donald L. Wise, Debra J. Trantolo, Hilary I. Inyang, Edward J. Cichon (2000) Remediation Engineering of Contaminated Soils, Publisher: Marcel Dekker Inc
9. Manoj Datta, Waste Disposal in Engineering landfills, Narosa Publishing House, New Delhi
10. Amalendu Badchi, Design of landfills and integrated solid waste management, John Wiley & Sons. Inc.

Course Contents and Lecture Schedule

Module	Topic	CO addressed	No. of Lectures
1 Module I: Total lecture hours:8			
1.1	Scope of geo-environmental engineering - multiphase behavior of soil – role of soil in geo-environmental applications	CO1	1
1.2	Importance of soil physics, soil chemistry, hydrogeology, biological process – impact of ground contamination on geo-environment	CO1	1
1.3	Regulatory requirement -Solid waste management rules (brief introduction only) -MoeF guideline	CO1	1
1.4	Geochemistry-Geochemical Attenuation-Quantification of attenuation capacities	CO1	1
1.5	Laboratory evaluation, sequential batch-contact testing & Column percolation testing.	CO1	1
1.6	Waste Characteristics of Municipal solid waste-Physical-Chemical & geotechnical	CO1	2
1.7	Identification of Hazardous and Non-Hazardous waste	CO1	1

2	Module II: Total lecture hours-7		
2.1	Contaminant transport-Transport process- Advection, Diffusion, Dispersion – Advection-Dispersion equation-Fick's equation.	CO2	2
2.2	Soil-water-contaminant interaction soil-water interaction and concepts of double layer	CO2	1
2.3	Evolution of waste containment facilities and disposal practices	CO3	1
2.4	Site selection based on environmental impact assessment	CO3	1
2.5	Different role of soil in waste containment	CO3	1
2.6	Hydrological consideration in land fill design	CO3	1
3	Module III: Total lecture hours: 8		
3.1	Containment technology, Landfill-Type-site selection	CO3	1
3.2	Landfill layout and capacity, components of landfill and its functions.	CO3	1
3.3	Types and functions of liner-natural clay liner, properties	CO3	2
3.4	Compacted clay liner- selection of soil for liner, properties-effect of compaction on permeability of clay.	CO3	2
3.5	Geo membrane liners-Types-geosynthetics clay liners , Type-methodology of construction, testing and design aspects.	CO3	2
4	Module IV: Total lecture hours: 7		
4.1	Primary and secondary leachate collection and removal systems.	CO3	1
4.2	Drainage, Collection, Removal and Filtration considerations of primary and secondary leachate collection and removal system. Various components and design considerations.	CO3	2
4.3	Cover system-Basic concept, Components-surface layer,	CO3	2

	Protection layer, Drainage layer, Barrier layer Assessment,		
4.4	Gas Management, Gas extraction systems-passive and active system	CO3	1
4.5	Closure and post closure monitoring system (brief introduction)	CO3	1
5	Module V: Total lecture hours: 6		
5.1	Site characterization – risk assessment of contaminated site	CO4	1
5.2	Remediation methods for soil and groundwater – selection and planning of remediation methods	CO4	1
5.3	In-situ / exit remediation, bio remediation, thermal remediation, pump and treat method, phyto remediation and electro-kinetic remediation	CO4	3
5.4	Stability of landfill (brief introduction), Soil exploration at contaminated site (brief introduction)	CO3	1



CET434	RAILWAY AND TUNNEL ENGINEERING	CATEGORY	L	T	P	CREDIT	YEAR OF INTRODUCTION
		PEC	3	0	0	3	2019

Preamble :To set a solid and firm foundation in Railway and Tunnel engineering, including the history, development, modern trends, maintenance, geometric design, construction and safety of railways and tunnel.

Prerequisite: Nil

Course Outcomes: After the completion of the course the student will be able to

CO 1	Explain the role of railways in national development and carry out geometric design of railway track by identifying component parts of railway track
CO 2	Design railway operation and control systems
CO 3	Analyze factors affecting railway accidents and understand the modern developments in railways and develop an awareness about the maintenance of railway system.
CO 4	Explain about the importance, types and methods of construction of tunnel
CO 5	Develop and analyze design aspects of ventilation, lining and lighting in tunnels

Mapping of course outcomes with program outcomes

	PO1	PO2	PO3	PO4	PO5	PO6	PO7	PO8	PO9	PO10	PO11	PO12
CO 1	2	2	3	1	-	1	-	1	2	2	-	1
CO 2	2	3	3	2	1	3	3	3	2	2	2	1
CO 3	2	3	2	1	-	1	1	2	-	2	2	1
CO 4	2	2	1	2	-	2	2	2	2	-	2	-
CO 5	2	2	-	2	1	2	1	2	-	-	2	1

Assessment Pattern

Bloom's Category	Continuous Assessment		End Semester Examination (marks)
	Test 1 Marks	Test 2 Marks	
Remember	7.5	7.5	30
Understand	7.5	7.5	30
Apply	5	5	20
Analyse	5	5	20
Evaluate			
Create			

Mark Distribution

Total Marks	CIE (Marks)	ESE (Marks)	ESE Duration
150	50	100	3 hours

Continuous Internal Evaluation Pattern:

Attendance	: 10 marks
Continuous Assessment Test (2 numbers)	: 25 marks
Assignment/Quiz/Course Project	: 15 marks

End Semester Examination Pattern:

The question consists of two parts- Part A and Part B. Part A consists of 10 questions with 3marks for each (two questions from each module). Part B consists of two questions from each module, out of which one has to be answered. Each question carries 14 marks and can have maximum 2 subdivisions.

Sample Course Level Assessment Questions:**Course Outcome 1 (CO1):**

Draw the typical cross section of railway in embankment and mark salient components. If the ruling gradient is 1 in 150 on a particular section of a broad gauge track and at the same time a curve of 4° is situated on a ruling gradient, what should be the allowable ruling gradient?

Course Outcome 2 (CO2):

How are crossings classified? What is the Number of crossing? Find out the crossing angle of 1 in 16 crossing by right angle method and centre line method.

Course Outcome 3 (CO3):

Why is packing of ballast carried out? An existing track is to be attended in packing ballast under the sleepers. What measures will you suggest as an engineer?

Course Outcome 4 (CO4):

Identify and describe the relevant method of constructing the tunnel in a given situation with justification

Course Outcome 5 (CO5):

For a given tunnel cross section, identify the method adopted for lining and ventilation of tunnels

SYLLABUS**Module -I**

Introduction to Railways in India: Role of Indian Railways in National Development – Railways for Urban Transportation –Alignment- basic requirements and factors affecting selection, Permanent Way: Typical cross-section- Component parts of a railway track - requirements and functions -Rails - Types of Rails, Rail Fastenings, Sleepers – Functions, Materials, Density, Ballast less Tracks.

Concept of Gauges, Coning of Wheels, Creeps and kinks. - Gradients - different types -Compensation of gradients, Geometric design of railway track: Horizontal curves, radius – superelevation -cant deficiency - transition curves

Module-II

Railway operation and control: Points and Crossings – Design features of a turnout – Details of station yards and marshalling yards – Signalling - Classification of signals, layout of Signals, interlocking of signals and points - Principles of track circuiting – Control systems of train movements – ATC, CTC

Module-III

Modern developments- LRT & MRTS, tube railways, high speed tracks. Maintenance: - Introduction to track maintenance, Items of track maintenance, packing and overhauling, screening

Railway accidents: Human and system contribution to catastrophic accidents, Human Factors in Transport Safety.

Module-IV

Tunnel Engineering: Tunnel - sections - classification - tunnel surveying-alignment, transferring centre, grade into tunnel – tunnel driving procedure- shield method of tunnelling, compressed air method, tunnel boring machine.

Module-V

Tunnel lining – Necessity, materials, methods, Ventilation – natural and mechanical ventilation, drainage of tunnels, dust control methods.

Text Books

1. Mundrey J. S, Railway Track Engineering, Tata McGraw Hill, 5th edition 2017
2. Srinivasan,R., Harbour, Dock & Tunnel Engineering, Charotar Publishing House, 28e, 2016
3. Rangawala, S.C. Railway Engineering, Charotar Publishing House 27th edition 2017
4. Bindra, S.P., A course in Docks and Harbour Engineering, Dhanpat Rai& Sons

References

1. Chandra, S. and Agarwal, M.M. ,Railway Engineering, Oxford University Press, New Delhi, Second edition 2013
2. Saxena, S. C and Arora, S. P, Railway Engineering, Dhanpat Rai & Sons, 7e, 2015
3. Subhash C. Saxena, Railway Engineering, Dhanpat Rai& Sons
4. H P Oza and G H Oza, Dock and Harbour Engineering, Charotar Publishing House 8th Edition 2017

Estd.



2014

Course Contents and Lecture Schedule

No.	Topic	Course Outcome	No. of Hrs
1	Module 1		Total: 11
1.1	Introduction to Railways in India: Role of Indian Railways in National Development – Railways for Urban Transportation –. Alignment- basic requirements and factors affecting selection, Typical cross-section	CO1	3
1.2	Permanent Way: Components and their Functions: Component parts of a railway track – requirements and functions –Rails – Types of Rails, Rail Fastenings, Sleepers – Functions, Materials, Density, Ballast less Tracks.	CO1	3
1.3	Concept of Gauges, Coning of Wheels, Creeps and kinks. – Gradients – different types –Compensation of gradients, Geometric design of railway track: Horizontal curves, radius – super elevation –cant deficiency – transition curves	CO1	5
2	Module 2		Total: 8
2.1	Railway operation and control: Points and Crossings – Design features of a turnout	CO2	4
2.2	Signalling – Classification of signals, layout of Signals, interlocking of signals and points	CO2	2
2.3	Principles of track circuiting – Control systems of train movements – ATC, CTC	CO2	2
3	Module 3		Total: 5
3.1	Modern developments- LRT & MRTS, tube railways, high speed tracks	CO3	2
3.2	Maintenance:- Introduction to track maintenance, Items of track maintenance, packing and over hauling, screening, Details of station yards and marshalling yards	CO3	2
3.3	Railway accidents: Human and system contribution to catastrophic accidents, Human Factors in Transport Safety.		1
4	Module 4		Total: 6
4.1	Tunnel Engineering: Tunnel - sections - classification - tunnel surveying -alignment, transferring centre, grade into tunnel – tunnel driving procedure	CO4	3
4.2	Tunnelling methods - Shield method of tunnelling, compressed air method, Tunnel boring machine.	CO4	3
5	Module 5		Total: 6
5.1	Tunnel lining – Necessity, materials, methods, Ventilation – natural and mechanical ventilation.	CO5	3
5.2	Drainage of tunnels, dust control methods	CO5	3

Model Question Paper

**APJ ABDUL KALAM TECHNOLOGICAL UNIVERSITY
EIGHTH SEMESTER B. TECH DEGREE EXAMINATION, MONTH & YEAR**

Course Code: CET 434

Course Name: RAILWAY AND TUNNEL ENGINEERING

Marks:100 Duration: 3 hrs

PART A

(Answer all questions. Each question carry three marks)

- 1 Briefly explain LRT and MRT.
- 2 Draw the typical cross section of railway in embankment and mark salient components.
- 3 What is meant by Super elevation? What are the objects of providing SE on curves?
- 4 Describe the advantages of transition curve.
- 5 With a suitable sketch illustrate a right hand turn out. Label the component parts on it.
- 6 What is the Number of crossing? Find out the crossing angle of 1 in 16 crossing by right angle method and centre line method.
- 7 Give reasons
 - a) In the absence of ganger, the keyman performs the duties of the ganger
 - b) Any occurrence, especially railway accidents, with the railway assumes a human dimension
- 8 Describe briefly the process of screening of ballast.
- 9 List different tunnel sections and identify the situation where each of them are preferred
- 10 Identify the sources from which water will be encountered during tunneling process and describe how management measures can be adopted.

PART B

(Answer one full question from each module)

11. (a) List and define the component parts of a railway track (4)
- (b) Explain the functions and requirements of rails and sleepers (6)
- (c) What are the factors affecting the alignment of a railway track. (4)

OR

12. (a) What is the equilibrium cant on a 20 curve on a BG track, if the speed of various trains are 10 trains at 50kmph., 8 trains at 55 kmph. and 4 trains at 60kmph. respectively (4)
- (b) Explain the various type of gradient used on railway track? What is grade compensation and why is it necessary? (4)
- (c) If an 7° curve track diverges from a main curve of 3° in opposite direction in the layout of a BG yard, calculate the super elevation and speed on the branch line, if the maximum speed permitted on the main track is 50 kmph. (6)

13. (a) Explain the following terms: Heel divergence and Flange way depth, (4)
- (b) Calculate all the necessary elements for a 1 in 12 BG turnout, taking off from a BG track with its curve, starting from the toe of the switch, Heel divergence= 12cm. (10)

OR

14. (a) How are signals classified? Explain each of them in detail. With suitable layout, show the different signals located on a section of a station. (5)
- (b) Classify and explain the various types of yards? What are the features of a marshalling yard? (5)
- (c) Illustrate the various methods adopted for the control of movement of trains. Explain ATC in detail. (4)
15. (a) Explain the operation and advantages of tube railways and high speed tracks. (7)
- (b) Discuss on conventional and advanced remedial Aids for preventing railway accidents. (7)

OR

16. (a) Explain how the accidents are classified on Indian Railways. (6)
- (b) What is a yard? What are the different types of yards? Explain the functions of a Marshalling yard and describe the points to be considered in its design. (8)
- 17.(a) Write down the procedure for constructing a tunnel in clayey soil. Explain its advantages. (Draw necessary diagrams). (8)
- (b) How is transferring of center line into the tunnel carried out? Explain with the help of neat diagram. (6)

OR

18. (a) List the various methods of tunneling in hard and soft rocks. Explain in detail any one tunneling method employed in hard strata and soft soil. (8)
- (b) Explain the procedure of tunnel driving using tunnel boring machine indicating the advantage and disadvantages of the process. (6)
19. (a) Write notes on (i) Lighting and (ii) Lining of tunnels. (7)
- (b) Explain in detail about different types of ventilation in tunnels. (7)
- OR**
20. (a) Explain different methods of ventilation of tunnels. (7)
- (b) Explain the dust control methods in tunnel. (7)

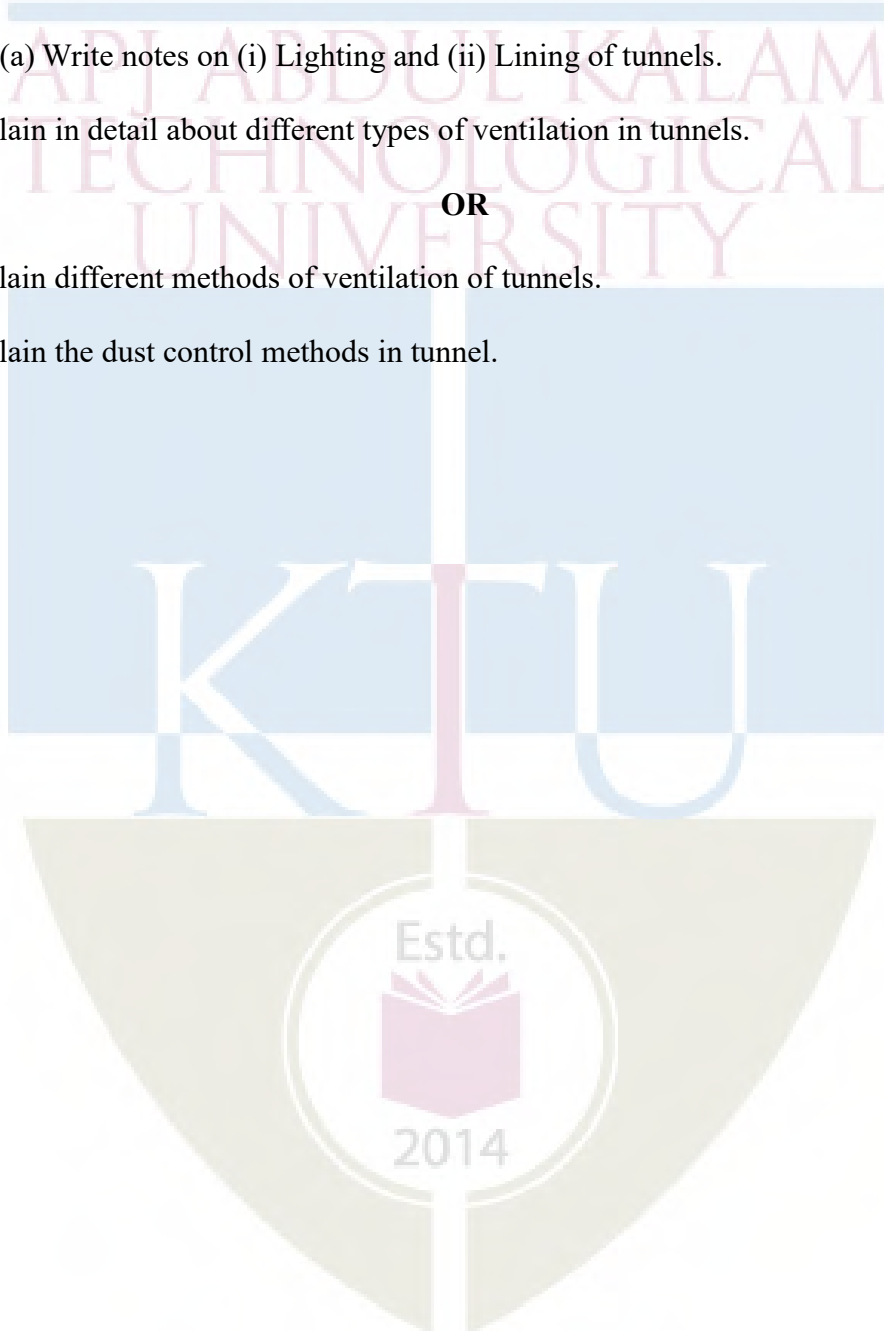

CET444	IRRIGATION AND DRAINAGE ENGINEERING	CATEGORY	L	T	P	CREDIT	YEAR OF INTRODUCTION
		PEC	3	0	0	3	2019

Preamble: The general objective of this course is to make the students familiar with the concepts of irrigation water scheduling, distribution and system performance. The course aim to impart the knowledge on surface and sub-surface systems for drainage of irrigation lands and the principles behind the reclamation of saline soils.

Pre-requisite: NIL

Course outcome :After the course, the student will be able to:

CO1	Determine the crop water requirement and understand the design of various surface irrigation methods
CO2	Perform scheduling of irrigation and evaluate irrigation system performance
CO3	Estimate properties of soil water zone, design open drains
CO4	Perform design of various drainage systems
CO5	Compute leaching requirement and design of drainage systems considering crop water requirement and leaching requirement

Mapping of course outcomes with program outcomes

CET444 Irrigation and Drainage Engineering		PO1	PO2	PO3	PO4	PO5	PO6	PO7	PO8	PO9	PO10	PO11	PO12
	CO1	3	3		1			1					
	CO2	3	3					1					
	CO3	3	2					1					
	CO4	3	3					1					
	CO5	3	3					1					

Assessment pattern

Bloom's Category	Continuous Assessment Tests		End Semester Examination (Marks)
	Test 1 (Marks)	Test 2 (Marks)	
Remember	5	5	15
Understand	10	10	15
Apply	20	20	40
Analyze	15	15	30
Evaluate			
Create			

Continuous Internal Evaluation Pattern:

Attendance	: 10 marks
Continuous Assessment Test (2 numbers)	: 25 marks
Assignment/Quiz/Course project	: 15 marks
Total	: 50 marks

End semester examination pattern – There will be two parts; Part A and Part B. Part A contain 10 questions with 2 questions from each module, having 3 marks for each question. Students should answer all questions. Part B contains 2 questions from each module of which student should answer any one. Each question can have maximum 2 sub-divisions and carry 14 marks.

Course Level Assessment Questions

Qn No	Question	Marks	Course outcome (CO) Assessed
Part A (Answer ALL Questions)			
1	What is surface irrigation? What are different methods of surface irrigation?	3	CO1
2	Calculate the Delta for kharif crop having Duty as 2500 ha/cumec. (Base period for kharif crop=123days)	3	CO1
3	What are the factors affecting the alignment of a water course?	3	CO2
4	What do you mean by drainage? What are the objectives of drainage?	3	CO2
5	What are the assumptions of Dupuit-Forchheimer (D-F) theory?	3	CO3
6	What do you mean by drainable porosity? How do you determine it?	3	CO3
7	Briefly explain the applications of Kraijenhoff Vande Leur Mass land equation for unsteady state drainage	3	CO4
8	Explain patterns of drainage system	3	CO4
9	Explain the terms soil salinity and water logging.	3	CO5
10	Define leaching requirement and the factors affecting it.	3	CO5
Part B (Answer ANY ONE FULL question from each module)			
Module I			

11(a)	What are the conditions favorable for selection of basin irrigation system?	5	CO1
11(b)	For a given field soil, the average infiltration rate is 45 mm per hour, and desired depth of water application corresponding to the depth of root zone is 50 mm. Determine (a) Optimum length of each border strip if the discharge of the water source entering into the border strip is 18 litres per second and width of each border strip is 9 m, and (b) The inflow rate if the length of each border strip is 150 m and its width is 9 m. What will be the time of water application in each case? Take the slope of the border strip as 0.35%.	9	CO1
12(a)	What is furrow irrigation method? What are the advantages and disadvantages of the method?	6	CO1
12(b)	A stream of 135 lit/sec was delivered from a canal and 100 lit/sec was diverted to the field. An area of 1.6 ha was irrigated in 8 hrs. The effective root zone depth is 1.8 m. The runoff loss in the field was 432 m ³ . The depth of water penetration varied linearly from 1.8 m at the head of the field to 1.2 m at the tail end. Available moisture holding capacity of the soil is 20 cm per m depth of soil. Determine the water conveyance efficiency, water application efficiency, water storage efficiency and water distribution efficiency. Irrigation was started at a moisture extraction level of 50% of the available moisture?	8	CO1
Module II			
13(a)	Explain different methods of irrigation water distribution	7	CO2
13(b)	Explain irrigation system performance indicators and methods of improving irrigation system performance	7	CO2
14(a)	The following data pertains to the healthy growth of a crop. (i) Field capacity of soil= 30% (ii) Permanent wilting percentage= 11% (iii) Density of soil=1300 Kg/m ³ (iv) Effective depth of root zone= 700 mm (v) Daily consumptive use= 12mm For healthy growth moisture content must not fall below 25% of the water holding capacity between the field capacity and the permanent wilting point. Determine the watering interval in days.	7	CO2
14(b)	Discuss about drainage problems in India	7	CO2

Module III			
15 (a)	Explain about classification of soil water.	4	CO3
15(b)	Derive Ernst equation with neat sketch for steady state flow.	10	CO3
16 (a)	Explain water table fluctuation maps and its uses.	4	CO3
16 (b)	Derive Hooghoudt's equation for spacing of tile drains under steady state conditions with neat sketch. Also state assumptions.	10	CO3
Module IV			
17(a)	Explain about the different layouts of the open drainage systems with neat sketches.	7	CO4
17(b)	Determine the size of the tile required at the end of a 300 m long tile line, if the drainage coefficient is 1.2 cm, grade is 0.2 percent and tile spacing is 60 m. Mannings roughness coefficient for tile drains is 0.04.	7	CO4
18(a)	Explain about the structures of a Pipe drainage system	8	CO4
18(b)	Derive Glover Dum equation for unsteady state flow.	6	CO4
Module V			
19 (a)	Write salt balance equation and explain the terms in it	4	CO5
19 (b)	Estimate the leaching requirement when electrical conductivity (EC) value of a saturated extract of soil is 10 m.mho/cm at 25% reduction in the yield of a crop. The EC of irrigation water is 1.2 m.mho/cm. What will be the required depth of water to be applied to the field if the consumptive use requirement of the crop is 80 mm? EC value of the leaching water may be suitably assumed.	10	CO5
20 (a)	Explain gravity outlet structures including their types and location	7	CO5
20 (b)	Classify salt affected soils based on the values of EC, ESP and pH of the soil saturation extract. Briefly explain about any one of them	7	CO5

Syllabus

Module I

Surface Irrigation methods: Classification – Border irrigation: design parameters, evaluation and ideal wetting pattern – Furrow irrigation: design parameters, types of furrows, evaluation, ideal wetting pattern – Basin irrigation: types of basins, ideal wetting pattern, shapes and size – Efficiency of surface irrigation methods. **Crop Water Requirements :** Infiltration and movement of water in soil– Soil-water-plant relationship – Water requirement of crops – Evapo transpiration (ET) and consumptive use - Effective rainfall – Irrigation requirement, Soil water balance, Yield response to water, Production functions .

Module II

Irrigation Water Distribution: Canal network and canal regulation –Methods of distribution: supply based and demand based – Delivery of water to farms –Measurement of water – Scheduling of irrigation – Criteria for scheduling, constraints – Frequency and interval of irrigation. **Irrigation System Performance Indicators:** Systems classification –Rehabilitation and modernization – Performance indicators – Improving system performance –constraints. **Land Drainage systems:** necessity-types-surfaces and subsurface drainage-design considerations.

Module III

Soil Water Zone: Description, Flow through soil water zone-Physical properties of soil-hydraulic conductivity-saturated thickness-drainable pore space-storativity, hydraulic resistance, leakage factor-Ground water data-concepts of ground water hydrograph, ground water maps, Isobath map, water table fluctuation maps etc. **Drainage studies**-continuity equation, Laplace equation, relaxation method of solution-Typical boundary conditions like impervious layer, plane of symmetry, freewater surface, water at rest or slowly moving water, seepage surface- Dupit Forchheimer Theory steady flow above an impervious horizontal boundary-Dupits equation-water table subject to recharge. **Flow into open drains**-steady state equations-Hooghoudt equation, Principles, applications for design use of nomographs for homogeneous and layered soils– Earnst equation, concept of horizontal vertical and radial flow, application to layered soils.

Module IV

Unsteady state drainage equations-Glover Dum equation, application, concept of Kraijenhoff Vande Leur Mass land equation, application- analysis for constant recharge, intermittent recharge cases. **Layout of open drainage systems:** types-Field drains, design considerations of ditch drains- Mole drains, design considerations, suitability- Sub-surface drainage systems- Pipe drainage systems-design for uniform and non-uniform flow conditions-transport and dewatering situations. Patterns of drainage system- Drainage criteria formulation for off season drainage, crop season drainage, salt drainage- use of steady state and unsteady state approaches in formulation. - criteria for irrigated area. –incorporation of intentional and unavoidable losses

Module V

Salinity and drainage- cause of salinity, salt balance equation, leaching efficiency, salt equilibrium equation and leaching requirement – salt storage equation – expressing equations in electrical conductivity terms-Design of a drainage system for an irrigated area based on crop water requirement and leaching requirement- Dynamic equilibrium concept. **Gravity outlet structures-** types, location.

Text Books:

1. Michel A M, Irrigation Theory and Practice, Vikas Publishing House, New Delhi, 2008.
2. Majumdar D P, Irrigation Water Management Principles and Practices, Prentice Hall of India, New Delhi, 2000.

References:

1. Irrigation and Drainage paper 24. Crop water requirement. FAO, Rome, 1977.
2. Irrigation and Drainage paper 56. Crop water requirement. FAO, Rome, 1988.
3. Kessler J, Drainage Principles and Applications, Volumes I to IV, International Institute for Land Reclamation and Improvement (ILRI), Netherlands, 1979.
4. Ritzema H P, Drainage Principles and Applications, Publication No. 16, International Institute of Land Reclamation and Improvement, Netherlands, 1994.
5. Bhattacharya A K and Michael A M, Land Drainage Principles: Methods and Applications, Konark Publishers Pvt. Ltd., New Delhi, 2003.

Course Contents and Lecture Schedule

Module	Topic	Course outcome addressed	No of Hours
Module I (6 Hours)			
1.1	Surface irrigation methods-classification	CO1	1
1.2	Design parameters of border, furrow and basin irrigation	CO1	2
1.3	Infiltration, soil-water-plant relationship, evapotranspiration	CO1	1
1.4	Effective rainfall, irrigation requirement, Soil water balance	CO1	1
1.5	Yield response to water, production functions	CO1	1
Module II (7 Hours)			
2.1	Methods of irrigation water distribution	CO2	1
2.2	Measurement of water, Scheduling of irrigation	CO2	1
2.3	Criteria for scheduling, constraints-frequency and interval of irrigation	CO2	1
2.4	Irrigation systems-classification, rehabilitation and modernization	CO2	1
2.5	Irrigation system performance indicators-improving system performance-constraints	CO2	1
2.6	Land drainage systems-necessity-types	CO2	1

2.7	Surfaces and subsurface drainage-design considerations	CO2	1
Module III (9 Hours)			
3.1	Soil water zone, flow through soil water zone, hydraulic conductivity, saturated thickness, storativity, hydraulic resistance, leakage factor	CO3	1
3.2	Ground water data-ground water hydrographs, groundwater maps, Isobath maps, Water table fluctuation maps etc.	CO3	1.5
3.3	Drainage studies-continuity equation, Laplace equation, relaxation method of solution, typical boundary conditions	CO3	2
3.4	Dupit Forchheimer Theory-steady flow above an impervious horizontal boundary, Dupits equation-water table subject to recharge	CO3	2
3.5	Flow into open drains-steady state equations-Hooghoudt equation, applications for design use of nomographs	CO3	1.5
3.6	Earnst equation, concept of horizontal, vertical and radial flow, application to layered soils	CO3	1
Module IV (8 Hours)			
4.1	Unsteady state drainage equations-Glover Dum equation, application	CO4	1
4.2	Kraijenhoff Vande Leur Mass land equation, application-analysis for constant and intermittent recharge	CO4	1
4.3	Layout of open drainage systems-types and design considerations and suitability	CO4	2
4.4	Sub-surface drainage systems-pipe drainage systems-design considerations-transport and dewatering situations	CO4	2
4.5	Patterns of drainage system-drainage criteria formulation for different conditions	CO4	1
4.6	Use of steady and unsteady state approaches in formulation-criteria for irrigated area-incorporation of losses	CO4	1
Module V (5 Hours)			
5.1	Salinity-causes, salt balance equation, leaching efficiency, salt equilibrium equation and leaching requirement	CO5	1
5.2	Salt storage equation, expressing equations in electrical conductivity terms	CO5	1
5.3	Design of a drainage system for an irrigated area based on crop water requirement and leaching requirement, Dynamic equilibrium concept	CO5	2
5.4	Gravity outlet structures-types, location	CO5	1

Model Question Paper

Reg No.:.....

QP

CODE:.....

Name:.....

APJ ABDUL KALAM TECHNOLOGICAL UNIVERSITY
EIGHTH SEMESTER B.TECH DEGREE EXAMINATION, MONTH & YEAR
Course Code: CET 444
Course Name: IRRIGATION AND DRAINAGE ENGINEERING

Max. Marks: 100**Duration: 3 hours****PART A****(Answer all questions; each question carries 3 marks)**

- 1 What is surface irrigation? What are different methods of surface irrigation? (3 marks)
- 2 Calculate the Delta for kharif crop having Duty as 2500 ha/cumec. (Base period for kharif crop=123days) (3 marks)
- 3 What are the factors affecting the alignment of a water course? (3 marks)
- 4 What do you mean by drainage? What are the objectives of drainage? (3 marks)
- 5 What are the assumptions of Dupuit-Forchheimer (D-F) theory? (3 marks)
- 6 What do you mean by drainable porosity? How do you determine it? (3marks)
- 7 Briefly explain the applications of Kraijenhoff Vande Leur Mass land equation for unsteady state drainage (3 marks)
- 8 Explain patterns of drainage system (3 marks)
- 9 Explain the terms soil salinity and water logging. (3 marks)
- 10 Define leaching requirement and the factors affecting it. (3 marks)

PART B**(Answer one full question from each module, each question carries 14 marks)****Module I**

- 11 a. What are the conditions favorable for selection of basin irrigation system? (5 marks)
- b. For a given field soil, the average infiltration rate is 45 mm per hour, and desired depth of water application corresponding to the depth of root zone is 50 mm. Determine (a) Optimum length of each border strip if the (9 marks)

discharge of the water source entering into the border strip is 18 litres per second and width of each border strip is 9 m, and (b) The inflow rate if the length of each border strip is 150 m and its width is 9 m. What will be the time of water application in each case? Take the slope of the border strip as 0.35%.

OR

- 12 a. What is furrow irrigation method? What are the advantages and disadvantages of the method? (6 marks)
- b. A stream of 135 lit/sec was delivered from a canal and 100 lit/sec was diverted to the field. An area of 1.6 ha was irrigated in 8 hrs. The effective root zone depth is 1.8 m. The runoff loss in the field was 432 m^3 . The depth of water penetration varied linearly from 1.8 m at the head of the field to 1.2 m at the tail end. Available moisture holding capacity of the soil is 20 cm per m depth of soil. Determine the water conveyance efficiency, water application efficiency, water storage efficiency and water distribution efficiency. Irrigation was started at a moisture extraction level of 50% of the available moisture? (8 marks)

Module II

- 13 a. Explain different methods of irrigation water distribution (7 marks)
- b. Explain irrigation system performance indicators and methods of improving irrigation system performance (7 marks)

OR

- 14 a. The following data pertains to the healthy growth of a crop. (7 marks)
- (i) Field capacity of soil= 30%
 - (ii) Permanent wilting percentage= 11%
 - (iii) Density of soil=1300 Kg/m³
 - (iv) Effective depth of root zone= 700 mm
 - (v) Daily consumptive use= 12mm

For healthy growth moisture content must not fall below 25% of the water holding capacity between the field capacity and the permanent wilting point. Determine the watering interval in days.

- b. Discuss about drainage problems in India (7 marks)

Module III

- 15 a. Explain about classification of soil water. (4 marks)
- b. Derive Ernst equation with neat sketch for steady state flow. (10 marks)

OR

- 16 a. Explain water table fluctuation maps and its uses. (4 marks)

- b. Derive Hooghoudt's equation for spacing of tile drains under steady state conditions with neat sketch. Also state assumptions. (10 marks)

Module IV

- 17 a. Explain about the different layouts of the open drainage systems with neat sketches. (7 marks)
- b. Determine the size of the tile required at the end of a 300 m long tile line, if the drainage coefficient is 1.2 cm, grade is 0.2 percent and tile spacing is 60 m. Mannings roughness coefficient for tile drains is 0.04. (7 marks)

OR

- 18 a. Explain about the structures of a Pipe drainage system (8 marks)
- b. Derive Glover Dum equation for unsteady state flow. (6 marks)

Module V

- 19 a. Write salt balance equation and explain the terms in it (4 marks)
- b. Estimate the leaching requirement when electrical conductivity (EC) value of a saturated extract of soil is 10 m.mho/cm at 25% reduction in the yield of a crop. The EC of irrigation water is 1.2 m.mho/cm. What will be the required depth of water to be applied to the field if the consumptive use requirement of the crop is 80 mm? EC value of the leaching water may be suitably assumed. (10 marks)

OR

- 20 a. Explain gravity outlet structures including their types and location (7 marks)
- b. Classify salt affected soils based on the values of EC, ESP and pH of the soil saturation extract. Briefly explain about any one of them (7 marks)

Estd.



2014

CET454	CONSTRUCTION METHODS AND EQUIPMENT	CATEGORY	L	T	P	CREDIT	YEAR OF INTRODUCTION
		PEC	3	0	0	3	2019

Preamble: This course introduces students to construction equipment and selected construction methods. This includes selection and technical fundamentals of common construction equipment and construction procedures for civil construction.

Prerequisite: CET309 Construction Technology & Management

Course Outcomes: After completion of the course, the student will be able to

Course Outcome	Description of Course Outcome	Prescribed learning level
CO1	Explain the various construction procedures for sub structures and super structures	Remembering, Understanding
CO2	Describe the various construction activities involved in underground and under water construction	Understanding
CO3	Demonstrate basic knowledge about construction equipment and machineries	Remembering, Understanding
CO4	Explain the equipment used for production of aggregates and concreting	Understanding
CO5	Select construction equipment appropriate to tasks.	Applying

Mapping of course outcomes with program outcomes (Minimum requirement)

	PO1	PO2	PO3	PO4	PO5	PO6	PO7	PO8	PO9	PO10	PO11	PO12
CO1	3					1	1	1		1		1
CO2	3					1	1	1		1		1
CO3	3					1		1		1		1
CO4	3					1				1		1
CO5	3	2				1				1	2	1

Assessment Pattern

Bloom's Category	Continuous Assessment Tests		End Semester Examination
	1	2	
Remember	10	10	10
Understand	40	30	76
Apply		10	14
Analyse			
Evaluate			
Create			

Mark distribution

Total Marks	CIE(Marks)	ESE (Marks)	ESE Duration
150	50	100	3hours

Continuous Internal Evaluation Pattern:

Attendance	:10marks
Continuous Assessment Test (2numbers)	: 25 marks
Assignment/Quiz/Course project	:15marks

End Semester Examination Pattern: There will be two parts; Part A and Part B. Part A contain 10 questions with 2 questions from each module, having 3 marks for each question. Students should answer all questions. Part B contains 2 questions from each module of which student should answer anyone. Each question carries 14marks and can have maximum 2 sub-divisions.

Course Level Assessment (Sample) Questions**CO1: Explain the various construction procedures for sub structures and super structures**

1. Explain the various types of construction joints.
2. Write short notes on vacuum dewatering of concrete flooring.
3. What is a slip form? Where they are used?
4. Discuss in detail various techniques used for launching heavy decks.
5. Discuss the construction methods of cable stayed bridges.
6. Explain the procedure involved in the construction of domes.

CO2: Describe the various activities involved in underground and under water construction.

1. Describe the procedure involved in the Piling technique.
2. What is a cofferdam? With the help of sketches explain various types of Cofferdams underground open excavation
3. What are the uses of diaphragm walls and sheet piles?
4. Write short notes on well foundation and caisson.
5. Explain the methods of dewatering foundations excavations.

CO3: Demonstrate basic knowledge about construction equipment and machineries

1. Discuss different types of earth work operations.
2. Explain the uses of various types of excavating equipment.
3. Explain the pile driving equipment in detail.
4. Describe the various equipment used for compaction in field.

CO4: Explain the equipment used for production of aggregates and concreting.

1. Explain the types of crushers used for production of aggregates.
2. Describe the uses of screening equipment.
3. Discuss different types of Mixers used for concrete mixing.
4. Explain the types of Pumps used in concrete construction.

CO5: Select construction equipment appropriate to tasks.

1. Mention the various types of earthwork equipment. Explain their uses.
2. Discuss the role of tractors in earth moving. What consideration govern selection of wheel type or crawler type tractor on a job?
3. What are the different types of cranes? Explain them in detail.
4. What are the advantages of using belt conveyors for transporting materials?
5. Compare the applications of various equipment used for compaction.

Syllabus

Module1

Construction techniques

Construction joints- movement and expansion joints –Vacuum Dewatering of Concrete Flooring – Techniques of construction for continuous concreting operation in Tall buildings – Slip Form techniques—Erection techniques of Tall structures, large Span Structures - Bridge Construction- Construction sequence and methods - Bow string bridges, cable stayed bridges - Launching techniques for heavy decks. Domes- Types — Construction sequence and methods in domes

Module2

Sub structure construction

Tunneling techniques- Piling techniques - driving well and caisson - sinking cofferdam- cable anchoring and grouting. Driving diaphragm walls, sheet piles - shoring for deep cutting -well points -dewatering and stand by Plant equipment for underground open excavation.

Module3

Equipment for Earth Work

Fundamentals of earth work operations - earth moving operations - types of earth work equipment - tractors, motor graders, scrapers, front end loaders – excavating and earth moving equipment- dozer, excavators, rippers, loaders - trucks and hauling equipment, compacting equipment, finishing equipment.

Module4

Equipment for production of aggregate and concrete

Equipment for production of aggregate and concreting - Crushers – Feeders - Screening Equipment – Handling Equipment- Batching and Mixing Equipment- Transit mixers - Hauling, Concrete Pouring and Pumping Equipment -Transporters

Module5

Other construction equipment

Pile driving Equipment - Erection Equipment – Cranes, Derrick Cranes, Mobile cranes, Overhead cranes, Traveller cranes, Tower cranes - Types of pumps used in Construction - Equipment for Dewatering and Grouting - Material Handling Conveyors –Industrial Trucks, Forklifts and related equipment.

Textbooks:

1. Peurifoy, R.L., Ledbetter, W.B. and Schexnayder, C., "Construction Planning, Equipment and Methods", McGraw Hill, Singapore, 2006.
2. Sharma S.C. "Construction Equipment and Management", Khanna Publishers, New Delhi, 1988.
3. Arora S.P. and Bindra S.P., Building Construction, Planning Techniques and Method of Construction, Dhanpat Rai and Sons, 1997

Reference books:

1. Deodhar, S.V. "Construction Equipment and Job Planning", Khanna Publishers, New Delhi,

1988.

2. Jerry Irvine, Advanced Construction Techniques, CA Rocketr, 1984
3. Dr.MaheshVarma, "Construction Equipment and its planning and Application", etropolitan Book Company, New Delhi. 1983

Course Contents and Lecture Schedule

Module	Topic	Course Outcomes addressed	No. of Lectures
1	Module I(7hours)		
1.1	Construction joints- movement and expansion joints –	CO1	1
1.2	Vacuum Dewatering of Concrete Flooring – Techniques of construction for continuous concreting operation in Tall buildings – Slip Form techniques	CO1	1
1.3	Erection techniques of Tall structures, large Span Structures	CO1	1
1.4	Bridge Construction- Construction sequence and methods - Bow string bridges, cable stayed bridges	CO1	2
1.5	Launching techniques for heavy decks.	CO1	1
1.6	Domes- Types — Construction sequence and methods in domes	CO1	1
2	Module II(6hours)		
2.1	Introduction to pile foundation- types, Piling techniques	CO2	1
2.2	Well foundation and caisson	CO2	1
2.3	Sinking cofferdam- cable anchoring and grouting	CO2	1
2.4	Driving diaphragm walls, sheet piles	CO2	1
2.5	Shoring for deep cutting	CO2	1
2.6	Well points -dewatering and stand by Plant equipment for underground open excavation.	CO2	1
3	Module III(7hours)		

3.1	Fundamentals of earth work operations - earth moving operations - types of earth work equipment	CO3, CO5	1
3.2	Tractors, motor graders, scrapers, front end loaders	CO3, CO5	2
3.3	Excavating and earth moving equipment- dozer, excavators, rippers, loaders	CO3, CO5	2
3.4	Trucks and hauling equipment	CO3, CO5	1
3.5	Compacting equipment, finishing equipment.	CO3, CO5	1
4	Module IV(7hours)		
4.1	Equipment for production of aggregate and concreting - Crushers	CO4	1
4.2	Feeders - Screening Equipment – Handling Equipment	CO4	2
4.3	Batching and Mixing Equipment - Transit mixers	CO4	2
4.4	Hauling, Concrete Pouring and Pumping Equipment - Transporters	CO4	2
5	Module V(8hours)		
5.1	Pile driving Equipment – Types of pile hammer: Drop hammer, Single acting and double acting steam hammers, Diesel hammers, Vibratory pile drivers	CO3, CO5	2
5.2	Erection Equipment – Cranes, Derrick Cranes, Mobile cranes, Overhead cranes, Traveller cranes, Tower cranes	CO3, CO5	2
5.3	Types of pumps used in Construction	CO3, CO5	1
5.4	Equipment for Dewatering and Grouting	CO3, CO5	1
5.5	Material Handling Conveyors –Industrial Trucks, Forklifts and related equipment	CO3, CO5	2

Model Question Paper

Reg.No.: _____

Name: _____

APJ ABDUL KALAM TECHNOLOGICAL UNIVERSITY**EIGHTH SEMESTER B.TECH DEGREE EXAMINATION**

Course Code: CET454

Course Name: **CONSTRUCTION METHODS & EQUIPMENT**

Max.Marks:100

Duration:3Hours

PARTA*Answer all questions. Each question carries 3 marks.*

1. What is the necessity of providing construction joints?
2. Discuss Slip form technique.
3. What is a box caisson? Where do we use it?
4. What are problems normally occur during deep excavations.
5. Discuss different types of earth work operations.
6. What are the uses of a grader?
7. What is a transit mixer? Mention its uses
8. List out the various types of hauling equipment used in concrete construction.
9. What are the equipment used for grouting?
10. Explain different types of material handling conveyors.

(10×3marks=30marks)

PARTB*Answer one full question from each module. Each full question carries 14 marks.***Module I**

11. a) Write short notes on Vacuum Dewatering of Concrete Flooring (7 marks)
- b) Explain the erection techniques involved in the construction of Tall structures. (7marks)

OR

12. a) Discuss in detail various techniques used for launching heavy decks (7 marks)
- b) Explain the procedure involved in the construction of domes (7 marks)

Module II

13. a) What is a cofferdam? With the help of sketches explain various types of Cofferdams. (6 marks)
- b) Describe in detail about the various piling techniques. (8 marks)

OR

14. a) Explain the following with neat sketches. (8 marks)
- (i) Sheet piles
- (ii) Well point

- b) Explain the methods of dewatering foundations excavations. (6 marks)

Module III

15. Mention the various types of excavating equipment. Explain their uses. (14 marks)

OR

16. a) Describe in detail the various equipment used for compaction in field (8 marks)
- b) Discuss the role of tractors in earth moving. What consideration govern selection of wheel type or crawler type tractor on a job?. (6 marks)

Module IV

17. Describe the various equipment used for production of aggregates (14 marks)

OR

18. Discuss different types of Mixers used for concrete mixing. (14 marks)

Module V

19. Explain the pile driving equipment in detail (14 marks)

OR

20. What are the different types of cranes? Explain them in detail (14 marks)

CET464	AIRQUALITY MANAGEMENT	CATEGORY	L	T	P	CREDIT	YEAR OF INTRODUCTION
		PEC	3	0	0	3	2019

Preamble: The course is designed to provide engineering knowledge on air pollution, air quality monitoring and air pollution control strategies among students. It motivates the students in maintaining and improving the air quality of the environment and empower learners to take appropriate actions to reduce the air pollution for the benefit of the society.

Pre-requisite: Nil

Course outcome : After the course, the student will able to:

CO1	Explain the sources of air pollution and different types of air pollutant.
CO2	Describe the effect of air pollutants on vegetation, animals, materials and human health.
CO3	Discuss the different methods of ambient air quality monitoring system which supports an air quality management program.
CO4	Explain the meteorological aspects of air pollutant dispersion.
CO5	Describe the various air pollution control strategies that can be undertaken to meet the air quality goals.

Mapping of course outcomes with program outcomes

	PO1	PO2	PO3	PO4	PO5	PO6	PO7	PO8	PO9	PO10	PO11	PO12
CO1	3					2	2					
CO2	3					2	1					
CO3	3					2	2					
CO4	3					3	2					
CO5	3					2	2					

Assessment pattern

Bloom's Category	Continuous Assessment Tests		End Semester Examination (Marks)
	Test 1 (Marks)	Test 2 (Marks)	
Remember	15	15	30
Understand	20	20	40
Apply			
Analyze	10	10	20

Evaluate	5	5	10
Create			

Continuous Internal Evaluation Pattern:

Attendance	:	10 marks
Continuous Assessment Test (2 numbers)	:	25 marks
Assignment/Quiz/Course project	:	15 marks
Total	:	50 marks

End semester examination pattern – There will be two parts; Part A and Part B. Part A contain 10 questions with 2 questions from each module, having 3 marks for each question. Students should answer all questions. Part B contains 2 questions from each module of which student should answer any one. Each question can have maximum 2 sub-divisions and carry 14 marks.

Course Level Assessment Questions

Qn. No	Question	Marks	Course outcome (CO) Assessed
Part A			
1	What are the criteria air pollutants?	3	CO1
2	Define air pollution.	3	CO1
3	Explain effect of carbon monoxide on human health.	3	CO2
4	What are the sources of indoor air pollution?	3	CO2
5	Enumerate the assumptions in Gaussian plume model.	3	CO3
6	Explain Pasquill's stability curves.	3	CO3
7	Discuss National Ambient Air Quality Standards.	3	CO4
8	Explain the devices used for sampling gases and vapours.	3	CO4
9	Write short notes on scrubbing.	3	CO5
10	List the different methods for controlling the particulate air pollutants.	3	CO5

Part B (Answer ANY ONE FULL question from each module)			
Module I			
11(a)	Explain green house effect.	7	CO1
11(b)	Give a classification of the different types of air pollutants based on different criteria with suitable examples.	7	CO1
12	Explain major air pollution episodes.	14	CO1
Module II			
13(a)	Discuss the effects of indoor air pollutants.	7	CO2
13(b)	Discuss the effects of air pollutants on human health.	7	CO2
14(a)	Describe the effect of air pollution on environment.	9	CO2
14(b)	Write a short note on effect of air pollution on vegetation.	5	CO2
Module III			
15(a)	Explain the effect of meteorological factors on dispersion of air pollutant.	7	CO3
15(b)	Explain temperature lapse rate.	7	CO3
16	Explain advantages and disadvantages of Gaussian plume model.	14	CO3
Module IV			
17(a)	Briefly explain Emission Inventory.	5	CO4
17(b)	Explain the different methods for the collection of gaseous air pollutants.	9	CO4
18	Explain various methods used for the sampling of particulate air pollutants.	14	CO4
Module V			
19 (a)	Write short note on scrubbing.	5	CO5

19 (b)	Explain the working of an Electrostatic precipitator for particulate emission control. Also explain its advantages and disadvantages.	9	CO5
20	Explain various methods used for the control of particulate air pollutants.	14	CO5

Syllabus

Module I

Introduction- Components of Environment- Definition –Air Pollution- History of air pollution episodes- Sources of Air pollution – Industrial Processes causing Air Pollution- Air Pollutants- Types of Air Pollutants- Criteria Pollutants.

Module II

Effect of air pollutants on health, vegetation, animals and materials and environment- Green house effect - Indoor Air Pollution- Sources of indoor air pollutants- Effects of indoor air pollution.

Module III

Meteorological aspects of Air Pollutant Dispersion - Temperature and Pressure relationships- Atmospheric Stability- Temperature Lapse Rate- Inversions- Types, Plume behaviour. Dispersion of Air pollutants-Plume dispersion theory- Gaussian plume model (Derivation not required)- Assumptions- Advantages and Disadvantages- Pasquill's stability curves.

Module IV

Air Quality monitoring - Ambient air sampling - Collection of gaseous air pollutants-Collection of particulate Pollutants- Ambient Air Quality standards- Emission Inventory.

Module V

Control of Air Pollutants- Particulate emission control-methods, Scrubbing-Cyclones- Filtration- Electrostatic Precipitation-Gaseous emission control- adsorption, absorption, thermal methods.

Text Books :

1. C.S.Rao, “Environmental Pollution Control Engineering”, New Age International Pub., 2006
2. M.N. Rao & H.V.N Rao ,Air Pollution, Tata McGraw Hill Co. Ltd, Delhi, 1990.
3. Peavy H S, Rowe, D.R. Tchobanaglou “Environmental Engineering” McGraw Hill Education, 1985

References:

1. Beat Meyer, Indoor Air Quality, Addison – Wesley Publishers.
2. Chhatwal G. R., Encyclopedia of Environmental Pollution and Control, Vol.1, 2 &3, Anmol Publications.
3. Noel de Nevers, Air Pollution Control Engineering, McGraw Hill, New York, 1995.

4. J. R. Mudakavi, Principles and Practices of Air Pollution Control and Analysis, IK International Pvt Ltd, 2012
5. Perkins H.C, “Air Pollution” McGraw Hill Publications, 2004
6. S C Bhatia, Textbook of Air Pollution and Its Control , Atlantic publishers, 2007
7. S P Mahajan, Air Pollution Control, Common Wealth of Learning, Canada, Indian Institute of Science, Bangalore, 2006
8. Stern.A, “Air Pollution” (Volume I ,II & III) ,Academic Press New York, 1962

Course content and Schedule of Lecture

Module	Topic	Course outcome addressed	No of Hours
Module I (7 Hours)			
1.1	Introduction- Components of Environment	CO1	1
1.2	Definition –Air Pollution	CO1	
1.3	History of air pollution episodes	CO1	1
1.4	Sources of Air pollution	CO1	1
1.5	Industrial Processes causing Air Pollution	CO1	1
1.6	Air Pollutants	CO1	1
1.7	Types of Air Pollutants	CO1	1
1.8	Criteria Pollutants	CO1	1
Module II (7 Hours)			
2.1	Effect of air pollutants on health	CO2	1
2.2	Effect of air pollutants on vegetation and animals	CO2	1
2.3	Effect of air pollutants on materials and environment	CO2	1
2.4	Effect of air pollutants on materials and environment	CO2	1
2.5	Green house effect	CO2	1
2.6	Indoor Air Pollution	CO2	

2.7	Sources of indoor air pollutants	CO2	1
2.8	Effects of indoor air pollution	CO2	1

Module III (7 Hours)			
3.1	Meteorological aspects of Air Pollutant Dispersion	CO3	1
3.2	Temperature and Pressure relationships	CO3	
3.3	Atmospheric Stability	CO3	1
3.4	Temperature Lapse Rate	CO3	1
3.5	Inversions- Types, Plume behaviour	CO3	1
3.6	Dispersion of Air pollutants -Plume dispersion theory	CO3	1
3.7	Gaussian plume model	CO3	1
3.8	Assumptions-Advantages and Disadvantages	CO3	
3.9	Pasquill's stability curves	CO3	1
Module IV (7 Hours)			
4.1	Air Quality monitoring	CO4	1
4.2	Ambient air sampling	CO4	1
4.3	Collection of gaseous air pollutants	CO4	1
4.4	Collection of particulate Pollutants	CO4	1
4.5	Collection of particulate Pollutants	CO4	1
4.6	Ambient Air Quality standards	CO4	1
4.7	Emission Inventory	CO4	1
Module V (7 Hours)			
5.1	Control of Air Pollutants	CO5	1
5.2	Particulate emission control-methods	CO5	1

5.3	Scrubbing-Cyclones	CO5	1
5.4	Filtration- Electrostatic Precipitation	CO5	1
5.5	Gaseous emission control	CO5	1
5.6	Adsorption, absorption, thermal methods.	CO5	1
5.7	Thermal methods.	CO5	1

Model Question Paper

Reg. No.:.....

QP CODE:.....

Name:.....

APJ ABDUL KALAM TECHNOLOGICAL UNIVERSITY**EIGHTH SEMESTER B.TECH DEGREE EXAMINATION, MONTH & YEAR****Course Code: CET 464
Air Quality Management****Max. Marks: 100****Duration: 3 hours****Part A****(Answer all questions; each question carries 3 marks)**

1. What are the criteria air pollutants?
2. Define air pollution.
3. Explain effect of carbon monoxide on human health.
4. What are the sources of indoor air pollution?
5. Enumerate the assumptions in Gaussian plume model.
6. Explain Pasquill's stability curves.
7. Discuss National Ambient Air Quality Standards.
8. Explain the devices used for sampling gases and vapours.
9. Write short notes on scrubbing.
10. List the different methods for controlling the particulate air pollutants.

Part B

(Answer one full question from each module; each question carries 14 marks)

Module I

11. a) Explain green house effect. (7 Marks)
b) Give a classification of the different types of air pollutants based on different criteria with suitable examples. (7 Marks)

OR

12. Explain major air pollution episodes. (14 Marks)

Module II

13. (a) Discuss the effects of indoor air pollutants. (7 Marks)
(b) Discuss the effects of air pollutants on human health. (7 Marks)

OR

14. (a) Describe the effect of air pollution on environment. (9 Marks)
(b) Write a short note on effect of air pollution on vegetation. (5 Marks)

Module III

15. (a) Explain the effect of meteorological factors on dispersion of air pollutant. (7 Marks)
(b) Explain temperature lapse rate. (7 Marks)

OR

16. Explain advantages and disadvantages of Gaussian plume model. (14 Marks)

Module IV

17. (a) Briefly explain Emission Inventory. (5 Marks)
(b) Explain the different methods for the collection of gaseous air pollutants. (9 Marks)

OR

18. Explain various methods used for the sampling of particulate air pollutants. (14 Marks)

Module V

19. (a) Write short note on scrubbing. (5 Marks)
(b) Explain the working of an Electrostatic precipitator for particulate emission control. Also explain its advantages and disadvantages. (9 Marks)

OR

20. Explain various methods used for the control of particulate air pollutants. (14 Marks)

Assessment Pattern

Bloom's Category	Continuous Assessment Tests		End Semester Examination (Marks)
	Test 1 (Marks)	Test 2 (Marks)	
Remember	10	10	20
Understand	10	15	20
Apply	25	25	50
Analyse	5		10
Evaluate			
Create			

Mark Distribution

Total Marks	CIE Marks	ESE Marks	ESE Duration
150	50	100	3 hours

Continuous Internal Evaluation (CIE)Pattern :

Attendance	: 10 Marks
Continuous Assessment Test (2 numbers)	: 25 Marks
Assignment/Quiz/Course project	: 15 Marks

End Semester Examination (ESE)Pattern : There will be two parts; Part A and Part B. Part A contains 10 questions with 2 questions from each module, having 3 marks for each question. Students should answer all questions. Part B contains 2 questions from each module of which student should answer any one. Each question can have maximum 2 sub-divisions and carry 14 marks.

Sample Course Level Assessment Questions

(Questions may be framed based on the outline given under each course outcome)

Course Outcome 1 (CO1):

1. The relevance and impact of Architecture in human society
2. The concepts of architectural development
3. The fundamental principles of architectural design
4. Elements of architecture and its composition

Course Outcome 2 (CO2):

1. The fundamentals of styles in Architecture, World Architecture and its development
2. Understanding the classical Architecture Vocabulary- Roman
3. Concepts of structure and geometry in Greek Architecture, Orders of Architecture,
4. The development and features of Gothic and Renaissance architecture

5. The evolution and features of Indian Architecture- Buddhist, Hindu and Non-Islamic period
6. Evolution and factors that influenced the development of Kerala Architecture including materials, climate and socio economic factors

Course Outcome 3 (CO3):

1. Basics of Sustainability, Sustainable Development and its influence in sustainable architecture
2. Concept of Green Buildings, various rating systems and its comparison
3. Basic principles of resource-based planning, sustainable urban planning

Course Outcome 4 (CO4):

1. Basic concepts of evolution of town planning
2. Understanding of the problems associated with uncontrolled urban growth and industrialization
3. Urban planning legislations
4. Theories of urban planning like garden city concept, new towns and conservative surgery
5. Understanding of town planning surveys including landuse surveys and socio economic analysis

Course Outcome 5 (CO5):

1. Basic concepts of regional planning, zoning and sub division regulation
2. Understanding the concepts of FSI/FAR and its relevance in town planning
3. Understanding the principles of planning
4. Introduction to town planning regulations and guidelines

Syllabus

Module I

Architecture: definition – factors influencing architectural development-Principles and elements of architecture: Contrast, proportion, scale, balance, rhythm, character, colour and unity- Line, space, form and shape.

Module II

Characteristic features of a style – Characteristic features and examples from world architecture. Development of Roman vocabulary of Architecture, Structural and Engineering feats - Geometry and Greek Architecture, Greek Capitals and Orders. Gothic: Characteristics of Gothic churches and cathedrals, Renaissance: development of stone vaults into groined systems. Indian architecture: A brief study of the architecture of Buddhist, Hindu and Indo-islamic period. Introduction to Kerala Architecture: Evolution of architectural style, Factors that influenced the development of Kerala architecture: Materials, Climate & Socioeconomic factors.

Module III

Basic concepts of sustainability- goals for sustainable development- Introduction to the concept and issues of Sustainable Architecture - basic concept of Green Buildings- Green Rating systems (LEED and GRIHA) - Sustainable building practices in India.

Resource based planning – urban infrastructure planning in sustainability context- socioeconomic development and sustainable planning – sustainable new towns.

Module IV

Basics of planning: Evolution of towns – problems of urban growth – Benefits of planning - urbanization, industrialization and urban development; push and pull factors; migration trends and impacts on urban and rural development – beginning of town planning acts – ideal towns – garden city movement – concept of new towns and conservative surgery - comprehensive planning of towns. Basics of town planning surveys – Land use surveys and analysis – Socio-economic surveys.

Module V

Regional planning – Zoning and subdivision regulation – FSI/FAR – Neighbourhood planning – planning principles – site planning – site selection criteria for housing development – types – site analysis. Types of plans – master plans, development plans, etc. (introduction only). Spatial standards, performance standards, benchmarks, and variable standards; URDPFI guidelines, zoning regulations/ordinances and DCR and (development control rules and regulations). New Urbanism and Public participation in planning process.

Text/Reference Books:

1. James C. Snyder, Introduction to Architecture, McGraw-Hill, 1979
2. Francis D.K. Ching, A Visual Dictionary of Architecture
3. Leland M Roth; “Understanding Architecture: Its Elements, History and Meaning”; Craftsman House; 1994
4. Simon Unwin, Analysing Architecture; Routledge Publications, Taylor and Francis. 2014
5. “ A Global History of Architecture”, Francis D K ching, Mark M. Jarzombek, Vikramaditya Prakash, Wiley Pub: 2010
6. Sir Banister Fletcher, “A History of Architecture”, CBS Publications (Indian Edition),1999.
7. Vernacular Architecture: An Illustrated Handbook By R.W. Brunskill, 4th ed 2000 Faber and Faber
8. Cities in A Globalizing World – Global Report on Human Settlements 2001: by United Nations
9. John Ratcliffe, 1984, 'An Introduction to Town and Country Planning'
10. Kulsreshtha, 2012, 'Urban and Regional Planning in India: A handbook for professionals'
11. Ministry of Urban Affairs, Govt. of India, 'Urban and Regional Development Plan Formulation and Implementation Guidelines -2014'

Course Contents and Lecture Schedule:

Module	Contents	Outcomes Addressed	Hours
1	Module 1		7
1.1	Architecture: definition	CO 1	1
1.2	Factors influencing architectural development	CO 1	1
1.3	Principles and elements of architecture: Contrast, proportion, scale, balance	CO 1	1
1.4	Principles and elements of architecture-rhythm, character, colour and unity	CO 1	2
1.5	Principles and elements of architecture -Line, space, form and shape.	CO 1	2
2	Module 2		7
2.1	Characteristic features of a style	CO 2	1
2.2	Characteristic features and examples from world architecture.	CO 2	
2.3	Development of Roman vocabulary of Architecture	CO 2	1
2.4	Structural and Engineering feats Geometry and Greek Architecture Greek Capitals and Orders	CO 2	1
2.5	Gothic: Characteristics of Gothic churches and cathedrals	CO 2	1
2.6	Renaissance: development of stone vaults into groined systems	CO 2	1
2.7	Indian architecture: A brief study of the architecture of Buddhist, Hindu and Indo-islamic period.	CO 2	1
2.8	Introduction to Kerala Architecture: Evolution of architectural style	CO 2	1
2.9	Factors that influenced the development of Kerala architecture: Materials, Climate & Socioeconomic factors	CO 2	
3	Module 3		7
3.1	Basic concepts of sustainability- goals for sustainable development	CO 3	1
3.2	Introduction to the concept and issues of Sustainable Architecture	CO 3	1
3.3	Basic concept of Green Buildings	CO 3	1
3.4	Green Rating systems (LEED and GRIHA)	CO 3	
3.5	Sustainable building practices in India.	CO 3	1
3.6	Resource based planning – urban infrastructure planning in sustainability context	CO 3	1
3.7	socioeconomic development and sustainable planning	CO 3	1

3.8	sustainable new towns	CO 3	1
4	Module 4		7
4.1	Basics of planning:	CO 4	1
4.2	Evolution of towns – problems of urban growth – Benefits of planning - urbanization,	CO 4	
4.3	industrialization and urban development	CO 4	1
4.4	push and pull factors	CO 4	
4.5	migration trends and impacts on urban and rural development	CO 4	1
4.6	beginning of town planning acts – ideal towns	CO 4	1
4.7	garden city movement	CO 4	1
4.8	concept of new towns and conservative surgery - comprehensive planning of towns	CO 4	1
4.9	Basics of town planning surveys – Land use surveys and analysis – Socio-economic surveys	CO 4	1
5	Module 5		7
5.1	Regional planning – Zoning and subdivision regulation	CO 5	1
5.2	FSI/FAR	CO 5	
5.3	Neighbourhood planning	CO 5	1
5.4	planning principles	CO 5	
5.5	site planning – site selection criteria for housing development types – site analysis.	CO 5	1
5.6	Types of plans – master plans, development plans, etc.	CO 5	1
5.7	.Spatial standards, performance standards, benchmarks, and variable standards;	CO 5	1
5.8	URDPFI guidelines, zoning regulations/ordinances and DCR and (development control rules and regulations).	CO 5	1
5.9	New Urbanism and Public participation in planning process	CO 5	1

Model Question Paper

QP CODE:

Reg No.: _____

Name: _____

APJ ABDUL KALAM TECHNOLOGICAL UNIVERSITY
EIGHTH SEMESTER B.TECH DEGREE EXAMINATION, MONTH & YEAR

Course Code: CET474

Course Name : URBAN PLANNING AND ARCHITECTURE

Max. Marks: 100

Duration: 3 hours

Part A

(Answer all questions; each question carries 3 marks)

1. What is a Line? what are its types.
2. Explain the term 'Contrast'
3. Describe the orders of Architecture
4. What are the different styles of Hindu temples in India.
5. What do you understand by the term 'Global Warming'?
6. What does the term 'Renewable and Non-renewable sources' meant? Give Examples..
7. Describe the importance of socio economic survey in urban planning.
8. What are the planning features of 'Garden City'?
9. Describe the contents of development Plan.
10. Explain the term 'FAR'

PART B

(Answer one full question from each module, each question carries 14 marks)

Module – 1

11. (a) Explain the importance of 'scale and proportion' in Architectural Design (5 Marks)
(b) Explain about the characteristics and functions of lines, space and form in Architecture. (9 Marks)
12. (a) Discuss the pattern of evolution in architecture and the etymology of the word 'Architecture'.. (5 Marks)
(b) Briefly discuss the influences of elements in architectural spaces. (9 Marks)

Module – 2

13. (a) Briefly explain salient features of Gothic and Renaissance period. (5 Marks)
- (b) Explain the influence of Local materials on vernacular architecture with an example of Kerala Architecture. (9 Marks)
14. (a) What are the essential features and elements of Hindu temple Planning? (5 Marks)
- (b) Describe TAJ MAHAL emphasizing on both TOMB and GARDEN. (9 Marks)

Module – 3

15. (a) Define sustainable development. Describe the 3 spheres of sustainable development. Briefly explain on the 3 spheres of sustainable architecture. (5 Marks)
- (b) Discuss in detail the major objectives and fundamental principles in Green building concept. (9 Marks)
16. (a) Discuss in detail GRIHA rating system. What are the certification levels and discuss in detail the criteria for the rating system?. (7 Marks)
- (b) Explain in detail the energy consumed by a building in its life. Explain transportation energy and its significance in sustainable architecture. (7 Marks)

Module – 4

17. (a) Discuss about the contributions of Ebenezer Howard towards town planning. (5 Marks)
- (b) Principles of 'Conservative Surgery' as proposed by Patrick Geddes (9 Marks)
18. (a) Describe the importance of surveys in the urban planning process? (5 Marks)
- (b) With the help of examples, relate the influence of Industrial Revolution in the process of urbanization. (9 Marks)

Module – 5

19. (a) Compare and contrast the difference between Master Plan and Development Plan (5 Marks)
- (b) What are the functions and powers of District Planning committee as per Kerala Town and Country Planning Act, 2016 (9 Marks)
20. (a) "*The Right to Fair Compensation and Transparency in Land Acquisition, Rehabilitation and Resettlement (RFCTLARR) Act, 2013 address matters in land acquisition by creating active engagement of affected communities*" Substantiate this statement by the salient features of RFCTLARR Act, 2013. (9 Marks)
- (b) Explain the purpose and relevance of Environmental Protection Act, 1986. (5 Marks)

APJ ABDUL KALAM
TECHNOLOGICAL
UNIVERSITY

SEMESTER VIII

PROGRAM ELECTIVE IV



Assessment Pattern

Bloom's Category	Continuous Assessment Tests		End Semester Examination
	1	2	
Remember (K1)	5	5	10
Understand (K2)	10	10	20
Apply (K3)	20	20	40
Analyse (K4)	15	15	30
Evaluate (K5)	-	-	-
Create (K6)	-	-	-

Continuous Internal Evaluation pattern:

Attendance	: 10 marks
Continuous Assessment Tests	: 25 marks
Assignment/Quiz/Course project	: 15 marks
Total	: 50 marks

End Semester Examination Pattern: There will be two parts; Part A and Part B. Part A contain 10 questions with 2 questions from each module, having 3 marks for each question. Students should answer all questions. Part B contains 2 questions from each module of which student should answer any one. Each question can have maximum 2 sub-divisions and carry 14 marks.

Course Level Assessment Questions

(Questions may be framed based on the outline given under each course outcome)

Course Outcome 1 (CO1):

1. Explain functions of various bridge elements and criteria for site selection and planning of bridge alignment.
2. Explain considerations for hydraulic design, geotechnical and span arrangement.
3. Problems on discharge calculation and linear waterway calculation.

Course Outcome 2 (CO2):

1. Explain types of structural forms, its actions and span ranges.
2. Explain various loads on bridge elements and its evaluation..
3. Explain methods for analysis of bridge superstructure.
4. Problems on load calculation and corresponding forces and moments on superstructure and substructure.

Course Outcome 3 (CO3):

1. Explain Load combination principles for Serviceability Limit State and Ultimate Limit State.
2. Problems on design for flexure, shear and torsion of box culverts, RCC solid slab and T beam & slab.

Course Outcome 4 (CO4):

1. Explain cable profiling for PSC girders and computation prestress losses.
2. Problems on design for flexure, shear and torsion of PSC I girders composite with RCC slab and Steel plate girders composite with RCC slab.

Course Outcome 5 (CO5):

1. Explain types and functions of bearings.
2. Problems on stability analysis and design of abutment and pier.
3. Problems on stability analysis and design of open foundation, well foundation and pile foundation.

Syllabus

Module I

General Arrangement Design: Classification of Bridges - Codes of practices for Highway and Railway bridges (IRC & IRS) - Types and functions of Bridge Elements - Site selection and planning of bridge alignment with approaches. Considerations for width of bridges - Hydraulic Design - Geotechnical considerations - Considerations for Span Arrangement - Bridge Aesthetics - Preparation of General Arrangement Drawing.

Module II

Structural Analysis of Bridges: Types of Structural forms and actions - Solid slab - Voided slab – T beam and slab – I girder and slab - Box girder - Bow string girder – Arch - Extradosed bridge - Cable stayed bridge - Suspension bridge.

Loads on bridges as per codal provisions - Vehicle Load with impact and braking effect - Wind load - Shrinkage and temperature effect - Earth pressure - Water current force - Seismic effect.

Analysis methods for longitudinal and transverse actions - Orthotropic plate method - Grillage method – Pigeauds method - Courbon's method – Guyon-Massonet method using Morice and Little charts - Overview of FEM based analysis software and Bridge Information Modelling.

Module III

Design of RCC Superstructures: Limit State Design concepts as per IRC: 112 - Load combination principles for SLS and ULS – Design for flexure, shear and torsion of Box culverts - RCC Solid Slab – T beam and slab -Detailing of primary reinforcements as per on IRC: 112.

Module IV

Design of PSC and Steel Superstructure: Basic concepts of prestressing as per IRC: 112 - Prestress losses - Cable profiling – Design for flexure, shear and torsion of PSC I girders composite with RCC slab.

Design considerations for steel bridges as per IRC: 22 & IRC 24, Design of Steel plate girders composite with RCC slab

Module V

Design of Substructures and Foundation: Types and functions of Bearings as per IRC: 84 - metallic bearings - Elastomeric bearing - Pot bearing - Spherical bearing.

Design considerations for Substructures as per IRC: 78 - Stability analysis and design of Abutment - Pier. Design considerations for Foundations as per IRC: 78 - Stability analysis and design of open and well foundations - Pile foundation - Design of pile cap and piles for vertical and lateral loads.

Text Books

1. Johnson Victor D, “Essentials of Bridge Engineering”, 7th Edition, Oxford, IBH publishing Co. Ltd, 2006.
2. Rajagopalan N., “Bridge Superstructure”, Narosa Publishing House, 2006
3. Krishna Raju N., “Design of Bridges”, Oxford & IBH Publishing Co. Pvt. Ltd., 2012.
4. Praveen Nagarajan, “Design of Concrete Bridges”, Wiley
5. Jagadeesh T.R. & Jayaram M.A., “Design of Bridge Structures”, Prentice-Hall of India Pvt. Ltd., 2009.

References:

1. Standard Specifications and Code of Practice for Road Bridges, IRC, New Delhi
 - a) IRC:5-2015 “General Features of Design”
 - b) IRC:6-2017, “Loads and Load Combinations”
 - c) IRC:22-2015, “Composite Construction (Limit state design)”
 - d) IRC:24-2010, “Steel Road Bridges (Limit state design)”
 - e) IRC:78-2014, “Foundations and Substructure”
 - f) IRC:83 (Part-1 2015, Part-2 2018, Part-3 2018, Part-4 2015), “Bearings”
2. IRC:SP: 105-2015, “Explanatory Handbook to IRC:112”, IRC, New Delhi.
3. IRS “Concrete Bridge Code”, RDSO, Lucknow.
4. IRS “Substructure and Foundation Code”, RDSO, Lucknow.
5. Bakht, B. and Jaegar, L.G., "Bridge Analysis simplified", McGraw Hill, 1985.
6. Surana C.S., “Grillage Analogy in Bridge Deck Analysis “, Alpha Science Int. Ltd.
7. E. C. Hambly , “Bridge Deck Behaviour” , CRC Press, 2nd edition.
8. Raina V.K., "Concrete Bridge Practice", Tata McGraw Hill Publishing Company, New Delhi, 1991.
9. Ponnu Swamy, “Bridge Engineering”, 4th Edition, McGraw-Hill Publication, 2008.
10. Swami Saran, “Analysis and Design of sub-structures”, 2nd Edition, Oxford IBH Publishing co Ltd., 2006.

Course Contents and Lecture Schedule: 2014

Module	Topic	Course outcome addressed	No. of Lectures
Module I (7 hours)			
1.1	Classification of Bridges – based on function, span range, material, construction methodology. Introduction to codes of practices for Highway (IRC) and Railway (IRS) bridges. Functions of bridge elements such as deck slab, girder, bearing, pier, abutment, wing wall, foundation. Criteria for site selection for bridges. Planning of bridge alignment and approaches.	CO1	2

1.2	Geometric design considerations – number of lanes, width, gradient, superelevation, clearances for bridges. Geotechnical considerations – selection of foundation type.	CO1	1
1.3	Hydraulic Design – calculation of design discharge, linear waterway and maximum scour depth.	CO1	2
1.4	Considerations for Span Arrangement –economic span ranges, navigation requirement. Introduction to Bridge Aesthetics. Preparation of typical General Arrangement Drawing.	CO1	2
Module II (8 hours)			
2.1	Structural forms for bridges types and structural actions for Solid slab, Voided slab, T-beam and slab , I-girder and slab, Box girder, Bow string girder, Arch bridge, Extradosed bridge, Cable stayed bridge and Suspension bridge.	CO2	2
2.2	Loads on bridges as per codal provisions - Vehicle Load with impact and braking effects -Wind load – Temperature, shrinkage and creep effects - Earth pressure - Water current force - Seismic effect.	CO2	2
2.3	Analysis methods for longitudinal and transverse actions using Orthotropic plate method, Grillage method, Pigeauds method, Courbon’s method. Guyon-Massonet method.	CO2	1
2.4	Procedure for calculation of bending moment and shear force distribution in superstructure using Morice and Little charts.	CO2	2
2.5	Overview of FEM based analysis software and Bridge Information Modelling (BrIM).	CO2	1
Module III (7 Hours)			
3.1	Limit State Design concepts as per IRC: 112. Load combination principles for Serviceability Limit State (SLS) and Ultimate Limit State (ULS) as per IRC: 6.	CO3	2
3.2	Design procedure for Box culvert: Calculation of reinforcement for flexure, verification of shear at ULS. Verification of stress, crack width and deflection at SLS.	CO3	1
3.3	Design procedure for RCC Solid slab: Calculation of reinforcement for flexure, verification of shear at ULS. Verification of stress, crack width and deflection at SLS.	CO3	1
3.4	Design procedure for RCC T-beam and slab: Calculation of reinforcements for flexure, shear and torsion at ULS. Verification of stress, crack width and deflection at SLS.	CO3	2
3.5	Detailing of primary reinforcements as per on IRC: 112.	CO3	1
Module IV (7 Hours)			

4.1	Basic concepts of design for prestressing as per IRC: 112	CO4	1
4.2	Calculation of immediate and time dependent prestress losses. Cable profiling within limiting zone for no tension stresses.	CO4	1
4.3	Design procedure for PSC I girder composite with RCC slab: Calculation of reinforcements for shear and torsion at ULS. Verification of stress, crack width and deflection at SLS.	CO4	2
4.4	Limit State Design concepts for steel bridges as per IRC: 22 & IRC 24,	CO4	1
4.3	Design procedure for Steel girder composite with RCC slab: Steel plate girder design for flexure, shear and torsion. Design of shear connectors.	CO4	2
Module V (7 Hours)			
5.1	Types of Bearings as per IRC: 84: Functions and components of metallic bearings, Elastomeric bearing, Pot bearing, and Spherical bearing.	CO5	1
5.2	Design considerations for Substructures as per IRC: 78: Calculation of main reinforcement for abutment and pier.	CO5	2
5.3	Design considerations for Open and Well foundations as per IRC: 78: Stability analysis and design for flexure and shear at ULS and SLS.	CO5	2
5.4	Design considerations for Pile foundations as per IRC: 78: Design of pile cap and piles for vertical and lateral loads. Calculation of main reinforcement.	CO5	2

Model Question Paper**QP CODE:**

PAGES:2

Reg. .No: _____

Name: _____



APJ ABDUL KALAM TECHNOLOGICAL UNIVERSITY
EIGHTH SEMESTER B. TECH DEGREE EXAMINATION,
MONTH & YEAR
Course Code: CET416

Course Name: BRIDGE ENGINEERING

Max. Marks: 100

Duration: 3 Hours

(Use of IRC 5, 6, 22, 24, 78, 83, 112, SP:13, IRS codes and design charts may be permitted)

PART A (3 x 10 = 30 Marks)

Answer all Questions. Each question carries 3 Marks

1. State the criteria for bridge site selection.
2. State the functions of various bridge elements.
3. State the various structural forms of bridge superstructure with economic span ranges.
4. Name IRC standard vehicles with their gross vehicle weights.
5. Name the load combinations to be adopted for checking stress, crack width and deflection of RCC bridge structure as per IRC:6.
6. State the criteria for minimum and maximum percentage for longitudinal reinforcement of beams as per IRC:112.
7. Name immediate and long term prestress losses to be considered in a post tensioned bridge girder.
8. Draw the sketches of shear connectors used for steel plate girder composite with RCC deck slab superstructure.
9. Differentiate plain elastomeric and laminated elastomeric bearings with sketches.
10. State the functions of various components of a well foundation.

PART B (14 x 5 = 70 Marks)

Answer any one full question from each module. Each question carries 14 Marks

Module 1

11. a) Explain the criteria for fixing span arrangement for bridges. (4)
 b) With the help of diagram classify bridges based on their function and span range. (10)
12. a) Explain the geometric dimensions for a two lane highway bridge with footpaths as per IRC:5 with cross sectional sketches. (4)
 b) Investigation for a minor bridge in Western Ghats provides the following data: Catchment area = 175sq. km, wetted area and perimeter of stream cross section at high flood condition are 205sq.m and 61m respectively, rugosity coefficient = 0.05, hydraulic slope of river = 0.02. Calculate design discharge using Dickens, Ryve's, Inqli's and Mannings formulae as per IRC:SP:13. (10)

Module 2

13. a) Differentiate structural action of girder bridge and bow string bridge. (4)
 b) Consider a 25m effective span box girder superstructure supported on bearings. Determine the maximum reactions on bearings due to IRC Class A and Class 70R wheeled vehicles when it is placed without transverse eccentricity. (10)
14. a) Explain grillage method of analysis for bridge superstructure. (4)
 b) Determine the maximum bending moments due to live load in girders of a simply supported three girder RCC T-beam and deck slab using Courbon's method with the following data: clear span = 18.0m, carriageway width = 7.5m, spacing of girders = 2.5m Loading: IRC class 70R tracked vehicle with a transverse eccentricity of 1.1m from centre.(10)

Module 3

15. a) Explain the design loads to be considered in the design of box culverts with the help of sketches. (4)
- b) Determine the main flexural reinforcement for a RCC solid slab superstructure for IRC 70R tracked vehicle as per IRC:6 with the following data: clear span = 8.0m, carriageway width = 7.5m, kerb width = 0.5m, width of bearing = 0.5m, thickness of wearing coat = 65mm, assume self weight of hand rails as 0.1kN/m. grade of concrete = M30, grade of steel Fe500. (10)
16. Design the central longitudinal T-beam of a simply supported superstructure for highway bridge having 3 longitudinal beams with the following data: Effective span = 15m, spacing of T-beams = 3.0m, grade of concrete = M35, grade of steel = Fe500. Maximum bending moment at mid-span and shear force at support are given below:

	Self weight	Superimposed dead load	Wearing coat	Live Load
Bending moment (kNm)	668	35	181	1240
Shear force (kN)	196	10	50	409

Calculate flexural reinforcement required at mid-span and shear reinforcement at support and show the required steel bars in respective cross sections. Check for serviceability limit state need not be considered. (14)

Module 4

17. A prestressed concrete I-girder of a highway bridge superstructure having cross sectional area = 0.95m^2 , modulus of section $Z_{\text{top}} = 0.551\text{m}^3$, $Z_{\text{bottom}} = 0.661\text{m}^3$ is post tensioned with 3 cables of 12 numbers - 12.7mm dia 7ply low relaxation strands at downward eccentricity of 1.0m from CG of section at mid-span. Check the mid-span section for rare combination at SLS, if the immediate prestress loss is 10% of jack end stress and bending moment due to self weight of girder is 2302kNm. Check the stresses at top and bottom faces when the girder is composite with RCC deck slab having cross sectional area = 1.625m^2 , modulus of section $Z_{\text{top}} = 1.359\text{m}^3$, $Z_{\text{bottom}} = 0.693\text{m}^3$, bending moment due to superimposed dead load = 2445kNm, live load = 2717kNm and the total prestress loss is 25%. (14)
18. Determine the moment resistance capacity a steel plate girder of a bridge superstructure having web size: 1400mm x 16mm, top flange: 550mm x 25mm, bottom flange: 700mm x 32mm. Effective length for torsional buckling = 18m. Apply bending stress reduction factor as per IRC: 24. (14)

Module 5

19. a) Explain the functions of bearing and the components of a typical pot bearing with a neat sketch. (7)
- b) Determine the maximum vertical load on pile under a circular pier for a) 4x4 pile group and b) 2x3 pile group having the following data: downward vertical force at pier base = 4560kN,

longitudinal and transverse bending moment at pier base are 2600kN and 2350kN respectively, pile spacing in both directions = 2.5m. Self weight of piles and pile cap need not be considered. (7)

20. Explain the procedure to check the stability of open foundation for abutment for a) overturning, b) sliding and c) base pressure with neat sketches. (14)

APJ ABDUL KALAM
TECHNOLOGICAL
UNIVERSITY



CET426	ADVANCED FOUNDATION DESIGN	CATEGORY	L	T	P	CREDIT	YEAR OF INTRODUCTION
		PEC	3	0	0	3	2019

Preamble: Goal of this course is to impart to the students, in-depth knowledge about the basic concepts and theories of foundation design. After this course the students will be able to understand and apply the design considerations to satisfy the major and other requirements of the geotechnical design of foundations.

Pre-requisite : Geotechnical Engineering -II

Course Outcomes: On successful completion of the course the student will be able to:

CO 1	Explain allowable soil pressure and safe bearing capacity, evaluate safe bearing capacity of shallow foundations by IS formula
CO 2	Proportion and design pile foundations, evaluate settlement of pile groups , uplift capacity of single and group of piles in clay
CO 3	Calculate the deflection and ultimate lateral load capacity of vertical piles
CO 4	Evaluate the load carrying capacity of under reamed piles and load capacity and uplift resistance of belled piers
CO 5	Calculate depth of embedment for cantilever sheet pile walls in clay and sand, Analyse the considerations for design of machine foundations

Mapping of course outcomes with program outcomes (Minimum requirement)

	PO 1	PO 2	PO 3	PO 4	PO 5	PO 6	PO 7	PO 8	PO 9	PO 10	PO 11	PO 12
CO 1	3	-	-	-	-	-	-	-	-	-	-	-
CO 2	3	3	-	-	-	-	-	-	-	-	-	-
CO 3	3	3	-	2	-	-	-	-	-	-	-	-
CO 4	3	3	2	-	-	-	-	-	-	-	-	-
CO 5	3	3	3	-	-	-	-	-	-	2	2	-

Assessment Pattern

Bloom's Category	Continuous Assessment Tests		End Semester Examination (Marks)
	Test 1 (Marks)	Test 2 (Marks)	
Remember	5	5	10
Understand	10	10	20
Apply	25	25	50

Analyse			
Evaluate	10	10	20
Create			

Mark Distribution

Total Marks	CIE Marks	ESE Marks	ESE Duration
150	50	100	3 hours

Continuous Internal Evaluation (CIE) Pattern :

Attendance	: 10 Marks
Continuous Assessment Test (2 numbers)	: 25 Marks
Assignment/Quiz/Course project	: 15 Marks

End Semester Examination (ESE) Pattern : There will be two parts; Part A and Part B. Part A contains 10 questions with 2 questions from each module, having 3 marks for each question. Students should answer all questions. Part B contains 2 questions from each module of which student should answer any one. Each question can have maximum 2 sub-divisions and carry 14 marks.

Course Level Assessment Questions

(Questions may be framed based on the outline given under each course outcome)

Course Outcome 1 (CO1):

- i) Understand allowable soil pressure and safe bearing capacity
- ii) Evaluate safe bearing capacity by IS
- iii) Evaluate allowable bearing capacity of footings subjected to moments
- iv) Understand the procedure of evaluating the safe bearing capacity of footings in layered soil

Course Outcome 2 (CO2):

- i) Calculate load carrying capacity from SPT and CPT, Values
- ii) Explain equivalent raft concept and evaluate the total consolidation settlement of pile groups
- ii) Evaluate pile group settlement in sand
- iii) Evaluate uplift capacity of single piles and group of piles in clay

Course Outcome 3 (CO3):

- i) Evaluate the safe bearing capacity of single bulb and double bulb under reamed piles in sand and clay.
- ii) Perform geotechnical design of under reamed piles as per IS

iii) Evaluate uplift capacity of piles and allowable soil pressure for belled piers

Course Outcome 4 (CO4):

1. Calculate the deflection and lateral load capacity of vertical piles for the following cases
 - i. Rigid and elastic piles in clay and sand for free headed and fixed headed condition using Brom's curves.
 - ii. Explain IS lateral load test

Course Outcome 5 (CO5):

- i) Evaluate the depth of embedment for cantilever sheet piles in sand and clay
- ii) Understand behavior of anchored bulkheads installed in clay and sand with concept of free earth and fixed earth support
- iii) Understand various terms related to vibration
- iv) Create mathematical models for free and forced vibrations with and without damping
- v) Explain the various design considerations of machine foundations
- vi) Evaluate the soil parameter for natural frequencies of block foundations
- vii) Explain different methods of vibration isolation and control

Syllabus

Module 1 (6 hrs)

Bearing capacity of shallow foundations-IS code formula - Numerical problems- Footings subjected to moments-Numerical problems- -Allowable bearing pressure from SPT N-values –Numerical problems- Footings on layered soil (concept only)

Module 2 (7 hrs)

Deep foundations- - Geotechnical Design of Piles from SPT and CPT-values-Numerical problems- Settlement of pile groups in clay and sand- equivalent raft approach-Numerical problems- Settlement of pile groups in sand-Skempton's method-Meyerhof's method- Numerical problems- Uplift capacity of single piles and group of piles in clay -Numerical problems-

Module 3 (7 hrs)

Under reamed piles – Load capacity in sand and clay-design considerations as per IS– numerical problems- Drilled piers (straight shafted and belled) in clay- - Design Considerations- Load Transfer Mechanism - Vertical Bearing Capacity and uplift capacity of belled pier-Numerical problems

Module 4 (8hrs)

Behavior of vertical piles under lateral loading, Pile resistance and deflection under lateral loads, IS and Brom's method, IS lateral load test on vertical piles- numerical problems

Module 5 (8 hrs)

Sheet pile walls-Types of sheet pile structures-Design of cantilever Sheet pile wall in clay and sand - Numerical problems-Anchored bulk heads –fixed earth and free earth support (concept only).

Machine foundations- Types of Machine foundations, basic definitions, degree of freedom of a block foundation, general criteria for design of machine foundation, free and forced vibrations, vibration analysis of a machine foundation, determination of natural frequency, vibration isolation and control.

Text Books:

1. Swami Saran, Analysis and design of substructures, Oxford & IBH publishing Co.PVt.Ltd. NewDelhi,2013
2. P.C.Varghese, Foundation Engineering, PHI Learning Private Limited, M-97, 2012
3. Das B. M., Principles of Geotechnical Engineering, Cengage India Pvt. Ltd., 2010.
4. Ranjan G. and A. S. R. Rao, Basic and Applied Soil Mechanics, New Age International, 2002.

References:

1. Arora K. R., Geotechnical Engineering, Standard Publishers, 2006.
2. Purushothamaraj P., Soil Mechanics and Foundation Engineering, Dorling Indersley (India) Pvt. Ltd., 2013
3. Murthy V.N.S, Geotechnical Engineering: Principles and practices of Soil Mechanics and Foundation Engineering, New York : Marcel Dekker, 2003.

Course Contents and Lecture Schedule:

Module	Contents	Outcomes Addressed	Hours
1	Module 1		6
1.1	Bearing capacity of shallow foundations-Review of terminology-IS code formula for safe bearing capacity of shallow foundation	CO1	1
1.2	Numerical problems	CO 1	1
1.3	Footings subjected to moments-effective width concept-Numerical problems	CO 1	1
1.4	Allowable bearing pressure from N Value-Teng's equations for safe bearing capacity of strip, square and circular footings, Safe bearing pressure for a permissible settlement	CO1	2
1.5	Numerical problem- Footings on layered soil concept with explanation	CO 1	1
2	Module 2		7
2.1	Deep foundations- Geotechnical Design of Piles from SPT and CPT -values-number and spacing-Numerical problems-	CO 2	2
2.2	Settlement of pile groups in clay-equivalent raft concept-Numerical problem	CO 2	2

2.3	Settlement of pile groups in sand-Skempton's method-Meyerhof's method-Numerical problem	CO 2	1
2.4	Uplift capacity of single piles and group of piles in clay - Numerical problems	CO 2	2
3	Module 3		7
3.1	Under reamed piles-ultimate load carrying capacity in sand and clay-design considerations as per IS	CO3	1
3.2	IS formula-single and double bulb -Numerical problems	CO 3	2
3.3	Drilled piers (straight shafted and belled) in clay- Design Considerations- Load Transfer Mechanism	CO 3	2
3.4	Vertical Bearing Capacity and uplift capacity of belled pier - Numerical problems	CO 3	2
4	Module 4		8
4.1	Behavior of vertical piles under lateral loading - Failure mechanisms of short piles in cohesive and granular soils for restrained and unrestrained conditions, given by (Broms)	CO 4	1
4.2	Failure mechanisms of long piles in sand and clay both free headed and fixed headed given by Broms-	CO4	1
4.3	Empirical Methods to Determine Lateral Strength of Piles-IS 2911 and Brom's method IS2911 method-concept and assumptions made- Criteria for classification of piles into short rigid piles or long elastic piles: Lateral load test on vertical piles.	CO4	1
4.4	Details of Broms Method- Chart for estimating the ultimate lateral resistance of short and long piles in clayey soils	CO 4	1
4.5	Chart for estimating the lateral deflection at ground level for piles in Clayey soils under working loads given by Broms.	CO 4	1
4.6	Chart for estimating the ultimate lateral resistance of short and long piles in sandy soils and Chart for estimating the lateral deflection at ground level for piles in Clayey soils under working loads given by Broms.	CO 4	1
4.7	Numerical problems using Brom's charts alone	CO 4	2
5	Module 5		8
5.1	Types of Sheet Pile Walls-Cantilever Sheet Pile Walls - Cantilever sheet pile walls with cohesion less backfill-deflection diagram-depth of embedment	CO 5	1
5.2	Cantilever sheet pile walls with cohesive backfill-depth of embedment	CO 5	1

5.3	Numerical problem- Anchored sheet pile walls-free earth support and fixed earth support analysis(concept only)-Rowe moment reduction factor	CO5	2
5.4	Machine foundations- Types of Machine foundations, basic definitions, -degree of freedom of a block foundation- general criteria for design of machine foundations	CO 5	1
5.5	Free vibration without damping –Spring mass system-free vibration with damping- Forced vibrations without damping-	CO 5	1
5.6	Vibration analysis of a machine foundation-determination of parameters required – Natural frequency of foundation soil system-Barken’s method-Numerical problems	CO 5	1
5.7	Vibration isolation-active and passive isolation-vibration control	CO 5	1

Model Question Paper**QP CODE:****Reg No.:** _____**Name:** _____

APJ ABDUL KALAM TECHNOLOGICAL UNIVERSITY
VIIIth SEMESTER B.TECH DEGREE EXAMINATION, MONTH & YEAR

Course Code: CET426

Course Name : ADVANCED FOUNDATION DESIGN

Max. Marks: 100

Duration: 3 hours

Note: Use of BROM's chart permitted

Part A

(Answer all questions; each question carries 3 marks)

1. Explain IS code formula for evaluating bearing capacity of shallow foundations.
2. Discuss the modifications made in evaluating the bearing capacity of a footing in a two layered soil deposit.
3. Explain equivalent raft concept of evaluating consolidation settlement of pile groups
4. Discuss on uplift capacity of a group of piles.
5. Sketch the failure mechanism of a rigid pile in clay given by Broms.
6. List the assumptions made in IS2911 for evaluating the lateral load capacity of a vertical pile.
7. Explain the basis of design of foundations on expansive soils
8. Explain the uses of under reamed piles
9. Differentiate between cantilever sheet piles and anchored bulk heads
10. Explain Barken's equation for evaluating natural frequency of a block foundation.

PART B

(Answer one full question from each module, each question carries 14 marks)

Module – 1

11. (a) Differentiate between safe bearing capacity and allowable soil pressure. (6 Marks)
- (b) The applied load on a shallow square foundation makes an angle of 15° with the vertical. Given $B = 1.85\text{m}$, $D_f = 1.2\text{m}$, $\gamma = 18.5\text{ kN/m}^3$, $\phi = 30^\circ$, $C = 26\text{ kN/m}^2$. Use $FS = 3$. Determine the gross allowable load, use IS6403 recommendations. (8 Marks)
- 12a). Explain Teng's equation for evaluating bearing capacity of shallow foundations. (4 marks)
- b). A square footing $1.8\text{m} \times 1.8\text{m}$ is loaded with an axial load of 1800 kN and $M_x = 450\text{ kNm}$ and $M_y = 360\text{ kNm}$. Given $\Phi = 36^\circ$, depth of footing $= 1.8\text{m}$, $\gamma = 18\text{ kN/m}^3$ WT at 6m below GL, determine net ultimate bearing capacity and factor of safety against shear failure. For $\Phi = 36^\circ$ take $N_q = 38$ and $N_\gamma = 56$. Use IS6403 recommendations and useful width concept (10 marks)

Module – 2

13. (a) Explain the criteria regarding optimum spacing of piles. (4 marks)
- b). A group of piles has to support a vertical axial load of 2000 kN . The piles are driven into clay and have a length of 10.5 m . The thickness of the clay stratum is 15 m . The clay is followed by a rock. The saturated unit weight of clay is 19 kN/m^3 and its cohesion is 25 kN/m^2 . The clay is normally consolidated and has a liquid limit of 60 . Its specific gravity is 2.7 . The water table is at the ground surface itself. Assuming the diameter of the piles as 300 mm , design a friction pile group. A factor of safety of 3 is required against shear failure. Compute its ultimate settlement. (10 marks)
14. (a) Explain evaluation of settlement of pile groups in sand (4 marks)
- (b) A concrete pile of 40 cm diameter is driven into a homogeneous mass of cohesionless soil. The pile carries a safe load of 650 kN . A static cone penetration test conducted at the site indicates an average value of $q_c = 40\text{ kN/m}^2$ along the pile and 12000 kN/m^2 below the pile tip. Compute the length of the pile with $FS = 2.5$. (10 Marks)

Module – 3

15. (a) Explain the load transfer mechanism of a belled pier in clay (4 Marks)
- (b) Estimate the load carrying capacity of drilled pier whose shaft is 100 cm diameter for a length of 8m . The diameter is belled to 250 cm in a length of 4 m at the bottom. The top 10 m of the pier passes through submerged soft clay ($\gamma_{\text{sat}} = 18\text{ kN/m}^3$) with cohesion 20 kPa . The pier rests on dense sandy gravel with an angle of friction of 38° . The values of N_c , N_q and N_γ for 38° are 75 , 80 and 50 respectively, $\omega = 0.8$. (10 Marks)
16. (a) Explain the advantages of an under reamed pile. (4 Marks)
- (b) A single under reamed pile is installed in a soft clay deposit. The centre of the under ream is located at a depth of 15m from the ground surface. The diameters of the pile shaft and bulb are

respectively 1m and 2.5m. determine the allowable load with a factor of safety of 2.5. The undrained shear strength of the soil obtained from the vane shear test is given by the relation $C_u = 65 + 7D$ where C_u is in kN/m^2 and D is the depth in metres. Assume $\alpha = 1$ (10 Marks)

Module – 4

17. (a) Differentiate between short and long piles. (4 Marks)
- (b) A steel pipe pile of 61 cm outside diameter with 2.5 cm wall thickness is driven into saturated cohesive soil to a depth of 20 m. The undrained cohesive strength of the soil is 85 kPa. Calculate the ultimate lateral resistance of the pile by Broms' method with the load applied at ground level. (10 Marks)
18. (a) Sketch the deflection diagram of an elastic pile under lateral load (4 Marks)
- (b) A reinforced concrete pile 50 cm square in section is driven into a medium dense sand to a depth of 20 m. The sand is in a submerged state. A lateral load of 50 kN is applied on the pile at a height of 5 m above the ground level. Compute the lateral deflection of the pile at ground level. Given: $n_h = 15 \text{ MN/m}^3$, $El = 1.15 \times 10^3 \text{ kN-m}^2$. The submerged unit weight of the soil is 8.75 kN/m^3 . If the pile is fully restrained at the top, what is the deflection at ground level? (10 Marks)

Module – 5

- 19 (a) Explain free earth analysis of anchored sheet pile walls. (4 Marks)
- (b) A cantilever sheet pile is to be installed in cohesion less soil of unit weight 20 kN/m^3 and $\phi = 30^\circ$. The height above dredge level is 6 m and water level above dredge level is 3 m. Estimate the depth of penetration needed for the sheet pile for stability. Find also the theoretical maximum bending moment in the pile (10 marks)
20. (a) Explain any one method of method of vibration control. (6 Marks)
- (b) Determine the natural frequency of a machine foundation of base area $2\text{m} \times 2\text{m}$ and weight 150 kN, assuming that the soil mass participating in the vibration is 20% of the weight of foundation. Take $C_u = 36,000 \text{ kN/m}^3$. (8 Marks)

CET436	TRANSPORTATION PLANNING	CATEGORY	L	T	P	CREDIT	YEAR OF INTRODUCTION
		PEC	3	0	0	3	2019

Preamble : The course aims to introduce to the students the concept of transportation planning and impart in-depth knowledge on the four stage planning process and to highlight the need for sustainable transportation

Prerequisite: Nil

Course Outcomes: After the completion of the course the students will be able to

CO 1	Identify the need for transportation planning, the issues and challenges related to transportation and its interaction with urban structure and land use (K3)
CO 2	Apply the concept of travel demand and analyse its role in transportation planning and to apply the concept in systems approach to transportation planning process. (K3,K4)
CO 3	Apply the concept of delineation of study area, sampling of data, and data collection techniques for the four stage planning process and to analyse the techniques for predicting trip generation.(K3,K4)
CO 4	Apply and analyse the methods for predicting trip distribution, mode split and traffic assignment (K3, K4)
CO 5	Apply the land use transport models and to analyse the sustainable approaches to transportation planning and preparation of comprehensive mobility plan with application of GIS (K3, K4)

Mapping of course outcomes with program outcomes

	PO1	PO2	PO3	PO4	PO5	PO6	PO7	PO8	PO9	PO10	PO11	PO12
CO 1		1	2	1		3	3	3				2
CO 2		1	2	2		2		1				2
CO 3	2	2	2	3	2	2		1				2
CO 4	3	3	3	3	3	2		1				2
CO 5	2	1	3	3	3	3	3	3		2	2	3

Assessment Pattern

Bloom's Category	Continuous Assessment		End Semester Examination (marks)
	Test 1 Marks	Test 2 Marks	
Remember	5	5	10
Understand	5	5	30
Apply	10	10	40
Analyse	5	5	20
Evaluate			
Create			

Mark Distribution

Total Marks	CIE (Marks)	ESE (Marks)	ESE Duration
150	50	100	3 hours

Continuous Internal Evaluation Pattern:

Attendance : 10 marks

Continuous Assessment Test (2 numbers) : 25 marks

Assignment/Quiz/Course Project : 15 marks

End Semester Examination Pattern:

The question consists of two parts- Part A and Part B. Part A consists of 10 questions with 3marks each (two questions from each module). Part B consists of two questions from each module, out of which one has to be answered. Each question carries 14 marks and can have maximum 2 subdivisions.

Sample Course Level Assessment Questions:

Course Outcome 1 (CO1):Identify the issues and challenges in transportation.

Course Outcome 2 (CO2):Analyse the concept of travel demand in the context of consumer behaviour

Course Outcome 3 (CO3): Compare the various models for predicting trip generation

Course Outcome 4 (CO4): Discuss the assumptions involved in various route choice models.

Course Outcome 5 (CO5):Elaborate on the sustainable approaches to transportation planning

Syllabus- Transportation Planning

Module 1	<p>Need for transportation planning- Characteristics of urban travel, Transportation issues and challenges, Detrimental effects of traffic on environment.</p> <p>Urban Structure- types and properties -centripetal, grid, linear, directional, Movement and Accessibility – Hierarchy of transportation facilities</p> <p>Transportation and land use - Role of urban activity analysis in transportation planning, Transportation impacts on activity system, Land use transportation interaction</p>
Module 2	<p>Role of demand analysis in transportation planning- Classification of urban transport demand and factors affecting demand, modelling based on consumer behavior of travel choices, Basic principles of travel demand analysis and assumptions.</p> <p>Transportation planning process -Systems approach, Elements/stages of transportation planning process - Goal, objectives and constraints, Trip-based and Activity-based approaches for transportation planning</p>
Module 3	<p>Data collection – Definition of study area, zoning- selection of cordon, Sampling techniques and sample size, Sources of data and types of surveys for planning, Evaluation of survey accuracy</p> <p>Trip Generation- Factors influencing trip generation, methods of forecasting trip generation rates- expansion factor, linear regression, category analysis</p>
Module 4	<p>Trip Distribution- Growth factor methods, Synthetic methods- Gravity models, opportunity model</p> <p>Modal Split- Factors influencing modal split, Types of mode split models – trip end, trip interchange, logit model</p> <p>Traffic assignment- Purpose, Elements of transportation networks- Nodes and links, Methods for traffic assignment</p>
Module 5	<p>Land use models- Selection of land use model, Lowry model-Structure, features, Model equation system</p> <p>Sustainable transportation- features, facilities, Transit oriented development, Non transport solutions to transport problems, Transportation demand management, Quick response techniques for demand estimation</p> <p>Comprehensive Mobility Plan- objectives and activities involved, Application of GIS in transport planning</p>

Text Books:

1. Bruton, M.J., Introduction to Transportation Planning, Hutchinson of London
2. Chakraborty, P and Das, A, Principles of Transportation Engineering
3. Hutchinson, B G, Principles of Urban Transport Systems Planning, McGraw Hill
4. Kadiyali, L.R, Traffic Engineering and Transport Planning, Khanna Publishers
5. Martin Rogers, Highway Engineering, Blackwell Science

References

1. Dickey, J. W. Metropolitan Transportation Planning, Tata McGraw Hill
2. Jotin Khisty, C, Transportation Engineering- An Introduction, Prentice Hall
3. Mayer, M.D and Miller, E .J, Urban Transportation Planning a Decision Oriented Approach, McGraw Hill.
4. Garber, N. J and Hoel, L. A, Traffic and Highway Engineering, PWS Publishing
5. Papacostas, C. S. and Prevedouros, P.D., Transportation Engineering and Planning, Prentice Hall.
6. Newman, P. and Kenworthy, J, Sustainability and Cities – Overcoming Automobile Dependence, Washington DC: Island Press.

Course Content and lecture Schedule:

No.	Topic	Course Outcome	No. of Hrs
1	Module 1		Total:7
1.1	Introduction, Urban travel characteristics, issues and challenges, Detrimental effects of traffic on environment.	CO1	3
1.2	Urban Structure, Movement and Accessibility, Hierarchy of transportation facilities	CO1	3
1.3	Transportation and land use	CO1	1
2	Module 2		Total: 8
2.1	Urban transport demand, factors affecting demand, modelling based on consumer behaviour of travel choices	CO2	3
2.2	Basic principles of travel demand analysis and assumptions.	CO2	1
2.3	Systems approach to planning, Stages of transportation planning process	CO2	2
2.4	Trip-based and Activity-based approaches for transportation	CO2	2

	planning	CIVIL ENGINEERING	
3	Module 3		Total: 7
3.1	Selection of study area, zoning	CO3	1
3.2	Sampling techniques	CO3	2
3.3	Data collection methods	CO3	2
3.4	Trip Generation	CO3	2
4	Module 4		Total: 7
4.1	Trip Distribution	CO4	3
4.2	Modal Split	CO4	2
4.3	Traffic assignment	CO4	2
5	Module 5		Total: 6
5.1	Land use models	CO5	2
5.2	Comprehensive Mobility Plan	CO5	2
5.3	Sustainable transportation, Transport Demand Management, Quick response techniques	CO5	2

Model Question Paper

**APJ ABDUL KALAM TECHNOLOGICAL UNIVERSITY
EIGHTH SEMESTER B. TECH DEGREE EXAMINATION, MONTH & YEAR**

Estd.
Course Code: **CET 436**

Course Name: **TRANSPORTATION PLANNING**

Max. Marks:100

Duration: 3 hrs

PART A

(Answer all Questions: Each question carries 3 marks)

- 1 What are the issues and challenges in transportation?
- 2 How transportation and land use are interrelated?
- 3 List the broad categories of urban demand classification.
- 4 Distinguish between goals and objectives in transport planning.
- 5 List out the need for sampling of data.

- 6 What are the three basic factors which affects trip generation?
- 7 What are the assumptions in growth factor models?
- 8 What are diversion curves?
- 9 What are the criteria for selection of land use transport model?
- 10 What is the importance of sustainable transportation?

(3 x 10=30 marks)

PART B**(Answer one full question from each module)**

- 11 a. Draw the directional type urban structure and state its characteristics. 10
- b. What are the characteristics of urban travel? 4

OR

- 12 a. Discuss the impacts of transportation on environment. 10
- b. Distinguish between movement and accessibility. 4

- 13 a. Discuss the factors affecting travel demand. 7
- b. What are the basic principles and assumptions in demand analysis? 7

OR

- 14 Discuss the various stages in the transportation planning process with a flow chart. 14

- 15 a. Discuss the various sampling techniques and their suitability. 10
- b. How can you estimate trip generation by expansion factor? 4

OR

- 16 a. Compare the multiple regression analysis and category analysis for predicting trip generation. 10

- b. What are the assumptions made in Multiple Linear Regression analysis? 4

- 17 a. What is the concept behind Gravity model? Explain the step by step procedure 10

for the calibration of Gravity model.

- b. Explain the capacity restraint assignment technique. 4

OR

- 18 a. Estimate the future trip matrix by Furness method if the present trip matrix and future trip production/ attraction are as follows. 10

Origin	Destination				Future trip production
	A	B	C	D	
A	8	3	8	10	32
B	5	8	9	6	42
C	15	16	3	8	147
D	12	7	4	2	30
Future trip attraction	68	24	39	120	

- b. Compare trip interchange and trip end mode split models. 4

- 19 a. Illustrate the Lowry model structure. 7

- b. What are the objectives of comprehensive mobility plan? 7

OR

- 20 a. Discuss how transport demand management measures can reduce congestion. 8

- b. Discuss briefly the quick response techniques for travel demand estimation. 6

CET446	INFORMATICS FOR INFRASTRUCTURE MANAGEMENT	CATEGORY	L	T	P	CREDIT	YEAR OF INTRODUCTION
		PEC	3	0	0	3	2019

Preamble: This course is aimed at exposing the students to the scope of Informatics and Internet of Things (IoT) in Civil Engineering. It introduces students to the fundamentals of data analytics, informatics & IoT as it is applicable to civil engineering field. After this course, students will be in a position to appreciate the use of informatics & IoT in civil engineering projects and follow the future developments in this sector.

Prerequisite: NIL

Course Outcomes: After the completion of the course the students will be able to

Course Outcome	Description of Course Outcome	Prescribed learning level
CO 1	Explain the fundamental concepts of data science, informatics & internet of things	Remembering, Understanding
CO 2	Identify the use of geomatics in planning and site selection of infrastructure projects	Applying & Analysing
CO 3	Apply building informatics in construction, monitoring and project management	Applying & Analysing
CO 4	Utilize IoT technology in infrastructure management	Applying & Analysing

Mapping of course outcomes with program outcomes (Minimum requirement)

	PO 1	PO 2	PO 3	PO 4	PO 5	PO 6	PO 7	PO 8	PO 9	PO 10	PO 11	PO 12
CO 1	2	-	-	-	-	-	-	-	-	-	-	-
CO 2	2	-	-	-	2	-	-	-	-	-	-	2
CO 3	2	-	-	-	2	-	-	-	-	-	-	2
CO 4	2	-	-	-	2	-	-	-	-	-	-	2

Assessment Pattern

Bloom's Category	Continuous Assessment Tests		End Semester Examination
	1	2	
Remember	10	10	15
Understand	10	10	15
Apply	15	15	35

Analyse	15	15	35
Evaluate			
Create			

Mark distribution

Total Marks	CIE	ESE	ESE Duration
150	50	100	3 hours

Continuous Internal Evaluation Pattern:

Attendance	: 10 marks
Continuous Assessment Test (2 numbers)	: 25 marks
Assignment/Quiz/Course project	: 15 marks

End Semester Examination Pattern: There will be two parts; Part A and Part B. Part A contain 10 questions with 2 questions from each module, having 3 marks for each question. Students should answer all questions. Part B contains 2 questions from each module of which student should answer any one. Each question carries 14 marks and can have maximum 2 sub-divisions.

Course Level Assessment Questions

(Questions may be framed based on the outline given under each course outcome)

Course Outcome 1 (CO1): Explain the fundamental concepts of data science, informatics & internet of things.

1. Explain DIKW pyramid.
2. Explain the data mining techniques
3. Discuss different data models
4. Discuss the vector data analysis techniques
5. Explain COBie standard
6. List IoT protocols
7. What are the elements of BIM?

Course Outcome 2 (CO2): Identify the use of geomatics for planning and site selection of infrastructure projects.

1. Discuss how geomatics help in site selection of a solid waste management facility
2. Discuss how terrain modeling is an important geographic information for project planning

Course Outcome 3 (CO3): *Apply building informatics in construction, monitoring and project management.*

1. How BIM helps in reducing the cost of construction?
2. Discuss the steps in developing a BIM for an infrastructure project.

Course Outcome 4 (CO4): *Utilize IoT technology in infrastructure management.*

1. How a water supply system could benefit by IoT technology?
2. Monitoring infrastructure projects could leverage from IoT technologies! Discuss.

Syllabus

Module 1 Data to Information

History of informatics, DIKW pyramid, data management- data types, Meta data, database management systems; Data analysis techniques-spatial and non-spatial data, trends and patterns

Module 2 Geoinformatics

Fundamental concepts in Geo-informatics- Components, Spatial data and attributes, vector and raster data models, Vector data analysis-buffering, overlay; Raster data analysis- local operations, neighborhood operations, zonal operations

Module 3 Planning and Site selection

Application of geoinformatic systems:

Site suitability analysis- Residential area, Industrial area and a Reservoir

Zoning- Ground water potential zonation, Hazard zonation

Network Analysis- Water supply line, Power line and a Road network

Module 4 Building Informatics

Building Information Modelling- Definition, Elements of BIM, steps in BIM development, COBie standard, potential and applications of BIM

Module 5 Internet of Things (IoT) in Civil Infrastructure

IoT Standards & Protocols, Concept of IoT in civil engineering- Applications in construction, product monitoring and project Management

Management Applications- Traffic Regulation, Water Supply and Smart Buildings

Text Books

1. J. Campbell, Essentials of Geographic Information Systems, Saylor Foundation, 2011.
2. RamezElmasri, ShamkantB.Navathe, "Fundamental of Database Systems", Pearson Addison Wesley, 2003.

3. BIM Handbook: A Guide to Building Information Modeling for Owners, Designers, Engineers, Contractors, and Facility Managers, Publisher: John Wiley & Sons; 2nd edition (1 July 2011), Language: English, ISBN-10: 9780470541371

Reference Books

1. Raja R. A. Issa and Svetlana Olbina, Building Information Modeling: Applications and Practices, ASCE, 2015.
2. Samuel Greengard, The internet of things, The MIT Press Essential Knowledge Series, 2015, ISBN: 978-0-262-52773-6.
3. ShashiShekhar and Sanjay Chawla, "Spatial Databases:A Tour", Prentice Hall, 2003.
4. Building Information Modeling: BIM in Current and Future Practice, Publisher: John Wiley & Sons; 1 edition (15 August 2014), Language: English, ISBN-10: 9781118766309

Course Contents and Lecture Schedule

Module	Topic	Course outcomes addressed	No. of Lectures
1	Module I : Total lecture hours : 7		
1.1	History of informatics	CO1	Lecture 1
1.2	DIKW pyramid & Meta data	CO1	Lecture 2
1.3	Data management	CO1	Lecture 3
1.4	Data types & Meta data	CO1	Lecture 4
1.5	Database management systems	CO1	Lecture 5
1.6	Data analysis techniques	CO1	Lecture 6
1.7	Trends & Patterns in data analysis	CO1	Lecture 7
2	Module II : Total lecture hours : 7		
2.1	Fundamental concepts in Geo-informatics-	CO1	Lecture 1
2.2	Components of GIS	CO1	Lecture 2
2.3	Spatial data and attributes	CO1	Lecture 3
2.4	Data models- vector & raster	CO1	Lecture 4
2.5	Vector data analysis	CO1	Lecture 5
2.6	Raster data analysis- local & neighbourhood analysis	CO1	Lecture 6
2.7	Raster data analysis- zonal analysis	CO1	Lecture 7

3	Module III : Total lecture hours : 7		
3.1	Site suitability analysis for Residential area	CO2	Lecture 1
3.2	Site suitability analysis for Industrial area	CO2	Lecture 2
3.3	Site suitability analysis for reservoir	CO2	Lecture 3
3.4	Ground water potential zonation& Hazard zonation mapping	CO2	Lecture 4
3.5	Network analysis for water supply	CO2	Lecture 5
3.6	Network analysis for power line	CO2	Lecture 6
3.7	Network analysis for road network	CO2	Lecture 7
4	Module IV : Total lecture hours : 7		
4.1	Building Information Modelling- Definition	CO3	Lecture 1
4.2	Elements of BIM	CO3	Lecture 2& 3
4.3	Steps in BIM development	CO3	Lecture 4 & 5
4.4	COBie standard	CO3	Lecture 6
4.5	Potential & applications of BIM	CO3	Lecture 7
5	Module V : Total lecture hours : 7		
5.1	IoT Standards & Protocols, Concept of IoT in civil engineering	CO4	Lecture 1
5.2	Application of IoT in construction, product monitoring & project management	CO4	Lecture 2,3 & 4
5.3	Management applications of IoT- Traffic, water supply, smar buildings	CO4	Lecture5,6 & 7

Model Question Paper**QP CODE:****Reg No.:** _____**Name:** _____

APJ ABDUL KALAM TECHNOLOGICAL UNIVERSITY
EIGHTH SEMESTER B.TECH DEGREE EXAMINATION, MONTH & YEAR

Course Code: CET 446

Course Name: INFORMATICS FOR INFRASTRUCTURE MANAGEMENT

Max. Marks: 100

Duration: 3 hours

Part A

(Answer all questions; each question carries 3 marks)

1. Explain different data types.
2. Explain DIKW pyramid.
3. Compare vector & raster model.
4. What are the components of GIS?
5. Explain network analysis.
6. What is the importance of terrain modeling?
7. Define BIM.
8. What is COBie standard?
9. List the IoT protocols.
10. Explain the concept of smart buildings.

PART B

(Answer one full question from each module, each question carries 14 marks)

11. (a) Discuss data analysis techniques for spatial data. (5 Marks)
- (b) Explain the steps in processing data into information. (9 Marks)

OR

12. (a) Briefly describe the history of informatics (5 Marks)
- (b) Explain various data analysis techniques. (9 Marks)

13. (a) Discuss various components of GIS (5 Marks)
- (b) Explain various vector analysis techniques. (9 Marks)

OR

14. (a) Explain buffering analysis. What is its application? (5 Marks)
- (b) Explain various raster data analysis techniques. (9 Marks)

15. (a) How the site suitability analysis is carried out for a reservoir? (7 Marks)
(b) Explain how geomatics is useful for mapping hazard zones. (7 Marks)

OR

16. (a) Explain the methodology for road network analysis. (7 Marks)
(b) Explain the process of converting data to information for a industrial area selection.

(7 Marks)

17. (a) What are the applications of BIM? (5 Marks)
(b) Discuss the steps in developing a BIM for an infrastructure project. (9 marks)

OR

18. (a) Explain the elements of BIM. (5 Marks)
(b) How BIM helps in reducing the cost of construction? (9 Marks)

19. (a) What sensors & devices would help in monitoring water distribution network. (5 Marks)

- (b) Infrastructure management could leverage from IoT technologies! Discuss. (9 Marks)

OR

20. (a) What are the selection criteria for sensors & devices used in IoT technologies. (7 Marks)
(b) Discuss how IoT technologies could help in traffic management. (7 Marks)



CET456	REPAIR AND REHABILITATION OF BUILDINGS	CATEGORY	L	T	P	CREDIT	YEAR OF INTRODUCTION
		PEC	3	0	0	3	2019

Preamble : Repair and Rehabilitation of Buildings is an elective course in the study of construction engineering. The course provides basic idea and needs of maintenance, repair , rehabilitation and strengthening measures of building structures and helps students to identify various deterioration mechanisms or damage mechanisms in buildings . The course introduces both scientific aspects and its practical applications at the site. Various non-destructive techniques and semi destructive techniques are introduced in this course, for damage diagnosis and assessment of a structure at the site. Several practices for maintenance and rehabilitation like surface repair, corrosion protection, structural strengthening and stabilization, etc. are discussed in details. At the end of the course students will be able to suggest evaluation and repair/maintenance methods for extending the service life of buildings.

Prerequisite : CET 303 Design of Concrete Structures

Course Outcomes: After the completion of the course the student will be able to

Course Outcome	Description of Course Outcome	Prescribed learning level
CO1	Recall the basics ideas and theories associated with Concrete technology and Masonry structures.	Remembering
CO2	Understand the need and methodology of repair and rehabilitation of structures, the various mechanisms used, and tools for diagnosis of structures	Understanding
CO3	Identifying the criterions for repairing / maintenance and the types and properties of repair materials used in site. Learn various techniques for repairing dam- aged and corroded structures	Understanding
CO4	Proposing wholesum solutions for maintenance/re- habilitation and applying methodologies for repair- ing structures or demolishing structures.	Applying
CO5	Analyse and asses the damage to structures using various tests	Analysing

Mapping of course outcomes with program outcomes (Minimum requirement)

	PO1	PO2	PO3	PO4	PO5	PO6	PO7	PO8	PO9	PO10	PO11	PO12
CO1	1											
CO2	3	2		2								
CO3	3	2	3		3	2	1					
CO4	3			1	3	2	1					
CO5	3	2	2	1	2		2					

Assessment Pattern

Bloom's Category	Continuous Assessment Tests		End Semester Examination
	1	2	
Remember	10	10	10
Understand	20	20	40
Apply	10	10	20
Evaluate			
Analyse	10	10	30
Create			

Mark distribution

Total Marks	CIE	ESE	ESE Duration
150	50	100	3 hours

Continuous Internal Evaluation Pattern:

Attendance	: 10
Continuous Assessment Test (2 numbers) marks	: 25
Assignment/Quiz/Course project	: 15

End Semester Examination Pattern: There will be two parts; Part A and Part B. Part A contain 10 questions with 2 questions from each module, having 3 marks for each question. Students should answer all questions. Part B contains 2 questions from each module of which student should answer any one. Each question carries 14 marks and can have maximum 2 sub-divisions.

Course Level Assessment (Sample) Questions

CO1: Recall the basics ideas and theories associated with Concrete technology and Masonry structures.

1. Discuss in details thermal properties of concrete
2. Discuss in detail the quality assurance for Concrete Construction
3. Write a brief note on permeability concrete
4. What are the factors affecting the durability of concrete?
5. Write a short note on effect of cover thickness?

CO2: Understand the need and methodology of repair and rehabilitation of structures, the various mechanisms used ,and tools for diagnosis of structures

1. What is underpinning?
2. Discuss the step by step procedure for epoxy injection to repair cracks in concrete
3. Briefly explain the various types of corrosion inhibitors
4. Enlist Strengthening Techniques and discuss the factors affecting strengthening methods
5. In which situation self compacting concrete is desirable?

CO3: Identifying the criteria for repairing / maintenance and the types and properties of repair materials used in site. Learn various techniques for repairing damaged and corroded structures

1. How do you classify maintenance of a structure?
2. What is overlay?
3. Elucidate Cathodic Protection of Steel Concrete?

CO4: Proposing wholusom solutions for maintenance/rehabilitation and applying methodologies for repairing structures or demolishing structures.

1. How can you develop a demolition strategy?
2. Describe a detailed assessment procedure for evaluating a damaged structure using a flow chart
3. How do you repair and rehabilitate a structure distressed due to fire.

CO5: Analyse and asses the damage to structures using various tests

1. Explain any three Non Destructive Tests used to test the strength of Concrete
2. What are partial destructive tests. Explain any one of them.
3. With a graph explain the service life behaviour of a concrete structure. Also explain in detail about time based maintenance

Syllabus

Module 1

Introduction - Maintenance, rehabilitation, repair, retrofit and strengthening, need for rehabilitation of structures. Cracks in R.C. buildings - Various cracks in R.C. buildings, causes and effects Damages to masonry structures - Various damages to masonry structures and causes

Module 2

Damage diagnosis and assessment - Various aspects of Inspection, Assessment procedure for evaluating a damaged structure, Visual inspection, Non Destructive Testing using Rebound hammer, Ultra sonic pulse velocity, Semi destructive testing, Probe test, Pull out test, Chloride penetration test, Carbonation, Carbonation depth testing, Corrosion activity measurement, Core test, Load test.

Module 3

Strength and Durability of Concrete - Quality assurance for concrete – Strength, Durability and Thermal properties of concrete – Effects due to climate, temperature, Sustained elevated temperature, Corrosion - effects of cover thickness. Substrate preparation - Importance of substrate/surface preparation, General surface preparation methods and procedure, reinforcing steel cleaning.

Module 4

Maintenance - Maintenance importance of maintenance, routine and preventive maintenance. Repair materials - Various repair materials, Criteria for material selection, Methodology of selection, Health and Safety precautions for handling and applications of repair materials. Special mortars and concretes- Polymer concrete, Sulphur infiltrated concrete, Fibre reinforced concrete, High strength concrete, High performance concrete, Vacuum concrete, Self compacting concrete, Self-healing concrete, Geopolymer concrete, Reactive powder concrete, Concrete made with industrial wastes, Polymer Concrete and Mortar, Quick setting compounds, Guniting and Shotcrete, Expansive cement, Ferro cement, Concrete chemicals. Grouting materials - Gas forming grouts, Salfoaluminate grouts, Polymer grouts, Acrylate and Urethane grouts. Bonding agents - Latex emulsions, Epoxy bonding agents. Protective coatings - Protective coatings for Concrete and Steel. FRP sheets

Module 5

Crack repair - Various methods of crack repair, Grouting, Routing and sealing, Stitching, Dry packing, Autogenous healing, Overlays, Repair to active cracks, Repair to dormant cracks. Corrosion of embedded steel in concrete - Corrosion of embedded steel in concrete, Mechanism, Stages of corrosion damage, Repair of various corrosion damaged of structural elements (slab, beam and columns) , Cathodic protection. Jacketing - Jacketing, Column jacketing, Beam jacketing, Beam Column joint jacketing, Reinforced concrete jackets, Steel jacketing, FRP jacketing. Strengthening - Strengthening of Structural elements, fire, Leakage, earthquake, Epoxy injection, Shoring, Underpinning.

Demolition Techniques - Non-explosive demolition, and Explosive demolition, engineered demolition techniques for dilapidated structures - Wrecking Ball Method, Concrete Sawing Method, Top down method, Hydraulic crusher, Implosion by delayed detonation technique

Text Books:

1. Concrete repair and maintenance Illustrated by Peter.H.Emmons, Galgotia publications Pvt. Ltd., 2001.
2. Repair and protection of concrete structures by Noel P.Mailvaganam, CRC Press, 1991.
3. “Earthquake resistant design of structures” by Pankaj agarwal, Manish shrikande, PHI, 2006.
4. “Concrete Structures, Materials, Maintenance and Repair”, Denison Campbell, Allen and Harold Roper, Longman Scientific and Technical UK, 1991.
5. Repair of Concrete Structures, Allen R.T. & Edwards S.C, Blakie and Sons, UK, 1987

References:

1. Failures and repair of concrete structures by S.Champion, John Wiley and Sons, 1961.
2. Diagnosis and treatment of structures in distress by R.N.Raikar Published by R & D Centre of Structural Designers and Consultants Pvt.Ltd, Mumbai.
3. Handbook on repair and rehabilitation of RCC buildings, CPWD, Government of India.
4. Handbook on seismic retrofit of buildings, A. Chakrabarti et.al., Narosa Publishing House, 2010
5. “Concrete Technology – Theory and Practice”, ShettyM.S., S.Chand and Company, 2008.
6. “Design and Construction Failures”, Dov Kominetzky.M.S., Galgotia Publications Pvt. Ltd., 2001
7. “Structural Health Monitoring, Repair and Rehabilitation of Concrete Structures”, Ravishankar.K., Krishnamoorthy.T.S, Allied Publishers, 2004.
8. Hand book on Seismic Retrofit of Buildings, CPWD and Indian Buildings Congress, Narosa Publishers, 2008.
9. “Concrete Technology”, Gambhir.M.L., McGraw Hill, 2013
10. “Self-Healing Concrete”, David J. Fisher, Materials Research Forum LLC, 20-May-2021
11. “Demolition: Practices, Technology, and Management”, Richard J. Diven, Mark Shaurette, 2011

Course Contents and Lecture Schedule

Module	Topic Course	Course Outcomes Addressed	No. of Lectures
1	Module I : Total lecture hours : 6		
1.1	Introduction - Maintenance, rehabilitation, repair, retrofit and strengthening, need for rehabilitation of structures	CO1 , CO2	1
1.2	Cracks in R.C. buildings - Various cracks in R.C. buildings, causes and effects	CO2	2
1.3	Damages to masonry structures - Various damages to masonry structures and causes	CO1	3
2	Module II : Total lecture hours : 8		
2.1	Damage diagnosis and assessment - Various aspects of Inspection, Assessment procedure for evaluating a damaged structure	CO2 , CO4, CO5	2
2.2	Visual inspection, Non Destructive Testing using Rebound hammer, Ultra sonic pulse velocity,	CO2 ,CO4	2
2.3	Semi destructive testing , Probe test, Pull out test, Chloride penetration test, Carbonation,	CO2, CO4	2
2.4	Carbonation depth testing, Corrosion activity measurement, Core test, Load test.	CO2 , CO4	2
3	Module III : Total lecture hours : 7		
3.1	Strength and Durability of Concrete - Quality assurance for concrete – Strength, Durability and Thermal properties of concrete	CO1 , CO3	1
3.2	Effects due to climate, temperature, Sustained elevated temperature, Corrosion - effects of cover thickness.	CO2 , CO3, CO4	2
3.3	Substrate preparation - Importance of substrate/ surface preparation,	CO2	2
3.4	General surface preparation methods and procedure, reinforcing steel cleaning.	CO3 , CO5	2
4	Module IV : Total lecture hours : 7		
4.1	Maintenance - Maintenance importance of maintenance, routine and preventive maintenance.	CO2,CO4	1
4.2	Repair materials -Various repair materials, Criteria for material selection, Methodology of Selection	CO2,CO1	1
4.3	Health and safety precautions for handling and applications of repair materials	CO2,CO3	1

4.4	Special mortars and concretes- Polymer concrete, Sulphur infiltrated concrete, Fibre reinforced concrete, High strength concrete,	CO1, CO2	1
4.5	High performance concrete, Vacuum concrete, Self compacting concrete, Self-healing concrete, Geopolymer concrete, Reactive powder concrete,	CO2, CO5	1
4.6	Concrete made with industrial wastes, Polymer Concrete and Mortar, Quick setting compounds, Guniting and Shotcrete, Expansive cement, Ferro cement, Concrete chemicals.	CO1, CO2, CO4	1
4.7	Grouting materials - Gas forming grouts, Sulfaluminate grouts, Polymer grouts, Acrylate and Urethane grouts. Bonding agents - Latex emulsions, Epoxy bonding agents. Protective coatings - Protective coatings for Concrete and Steel. FRP sheets	CO2, CO1	1
5	Module V : Total lecture hours : 7		
5.1	Crack repair - Various methods of crack repair, Grouting, Routing and sealing, Stitching, Dry packing, Autogenous healing, Overlays, Repair to active cracks, Repair to dormant cracks.	CO2, CO3	1
5.2	Corrosion of embedded steel in concrete - Corrosion of embedded steel in concrete, Mechanism, Stages of corrosion damage, Repair of various corrosion damaged of structural elements (slab, beam and columns) , Cathodic protection.	CO1, CO2	1
5.3	Jacketing - Jacketing, Column jacketing, Beam jacketing, Beam Column joint jacketing, Reinforced concrete jackets, Steel jacketing, FRP jacketing.	CO2, CO5	1
5.4	Strengthening - Strengthening of Structural elements, fire, Leakage, earthquake, Epoxy injection, Shoring, Underpinning.	CO2, CO1	1
5.5	Demolition Techniques - Non-explosive demolition, and Explosive demolition,	CO2, CO1	1
5.6	Engineered demolition techniques for dilapidated structures - Wrecking Ball Method, Concrete Sawing Method, Top down method, Hydraulic crusher, Implosion by delayed detonation technique.	CO2, CO4, CO5	2

Model Question Paper

**APJ ABDUL KALAM TECHNOLOGICAL UNIVERSITY
EIGHTH SEMESTER B. TECH DEGREE EXAMINATION, MONTH & YEAR**

Course Code: CET 456

Course Name: REPAIR AND REHABILITATION OF BUILDINGS

Marks : 100

Duration : 3 hrs

PART A

(Answer all Questions. Each Question carries 3 Marks)

1. What is Inspection and Mention its purpose?
2. What is the difference between maintenance and rehabilitation of structures ?
3. List any three causes of deterioration of structures ?
4. State the properties of Corrossion Inhibitors ?
5. List four engineered demolition techniques for RCC structures ?
6. List two methods of retrofitting of concrete structures subjected to leakage ?
7. What is Shoring and state its purpose?
8. Define Durability and name two tests to assess durability.
9. Mention a salient feature and application of polymer concrete.
10. List the types of Polymer Concrete

PART B

(Answer one full question from each module, Each question carries 14 marks)

Module 1

11. What are the types of Cracks in R.C.C buildings . Explain the causes and effects .

OR

12. Explain the service life behaviour of a concrete structure with a Graph. Also explain in detail about time based maintenance.

Module 2

13. Explain the following Non Destructive Testing techniques in detail as per IS

- i) Rebound Hammer Test
- ii) Ultrasonic Pulse Velocity

OR

14. Explain the following Testing techniques in detail as per IS

- i) Semi destructive testing

- ii) Probe test
- iii) Pull out test
- iv) Chloride penetration test

Module 3

- 15. Discuss the effects of temperature and climate on concrete structures
OR
- 16. Discuss in detail the quality assurance for Concrete Construction

Module 4

- 17. (a) Explain carbonation of concrete in detail.
(b) Write a brief note on Ferrocement
OR
- 18. (a) Write short note on expansive cement
(b) Define alkali aggregate reaction, explain causes and preventive measures of alkali aggregate reaction

Module 5

- 19. Discuss the implosion method of demolition of Structures .
OR
- 20. How do you repair and rehabilitate a structure damaged due to fire.



CET466	ENVIRONMENTAL REMOTE SENSING	CATEGORY	L	T	P	CREDIT	YEAR OF INTRODUCTION
		PEC	3	0	0	3	2019

Preamble: This course introduces students to the concepts of remote sensing and its applications in environmental monitoring. They will learn basic terminology and physics of remote sensing, characteristics of sensors and image processing fundamentals. The students will also explore how satellite based remote sensing play a significant role in monitoring land, vegetation, soil, air and water resources.

Prerequisite: NIL

Course Outcomes: After the completion of the course the student will be able

Course Outcome	Description of Course Outcome	Prescribed learning level
CO1	Describe the physics of remote sensing	Remembering
CO2	Explain the concepts of image processing	Understanding
CO3	Explain existing technologies, data products and algorithms useful in environmental remote sensing	Understanding
CO4	Show the role of remote sensing in monitoring land, vegetation, soil, air and water	Applying

Mapping of course outcomes with program outcomes (Minimum requirement)

	PO 1	PO 2	PO 3	PO 4	PO 5	PO 6	PO 7	PO 8	PO 9	PO 10	PO 11	PO 12
CO 1	3	-	-	-	3	-	-	-	-	-	-	-
CO 2	3	-	-	-	3	-	-	-	-	-	-	-
CO 3	3	-	-	-	3	-	-	-	-	-	-	-
CO4	3	-	-	-	3	-	-	-	-	-	-	-

Assessment Pattern

Bloom's Category	Continuous Assessment Tests		End Semester Examination
	1	2	
Remember	10	10	25
Understand	10	10	25

Apply	30	30	50
Analyse			
Evaluate			
Create			

Mark distribution

Total Marks	CIE	ESE	ESE Duration
150	50	100	3 hours

Continuous Internal Evaluation Pattern:

Attendance	: 10 marks
Continuous Assessment Test (2 numbers)	: 25 marks
Assignment/Quiz/Course project	: 15 marks

End Semester Examination Pattern: There will be two parts; Part A and Part B. Part A contain 10 questions with 2 questions from each module, having 3 marks for each question. Students should answer all questions. Part B contains 2 questions from each module of which student should answer any one. Each question carries 14 marks and can have maximum 2 sub-divisions.

Course Level Assessment Questions

CO1: Describe the physics of remote sensing

1. What are atmospheric windows?
2. How spectral signatures are useful in classifying land surface features?
3. Compare active and passive remote sensing.

CO2: Explain the concepts of image processing

1. What are False Colour Composites?
2. Explain the geometric corrections applied on satellite images.
3. What are the elements of visual image interpretation?

CO3: Explain existing technologies, data products and algorithms useful in environmental remote sensing

1. Explain the use of LIDAR for monitoring atmospheric profiles.
2. Discuss the capabilities of any 3 satellite sensors.
3. Explain the levels in satellite data products.

CO4 Show the role of remote sensing in monitoring land, vegetation, soil, air and water

1. What are vegetation indices? How these indices are useful in environmental monitoring?
2. What is aerosol optical depth? How they are used in air quality monitoring?
3. How oil spills are detected using satellite remote sensing?

Syllabus**Module 1**

Physics of remote sensing, interaction of earth surface features with electromagnetic radiations, atmospheric windows, effects of atmosphere, spectral signatures

Types of remote sensing, active and passive measurements, platform characteristics, satellite orbits, some popular satellite sensors-Landsat, MODIS, Sentinel, SCATSAT and INSAT 3D R

Module 2

Sensor characteristics-spatial, temporal, spectral, radiometric resolutions, principles of image processing, methods of encoding image data-BIL, BIP, BSQ, False Color Composite (FCC), elements of visual image interpretation, image correction techniques- atmospheric, geometric and radiometric, principles of photogrammetry, algorithms and data products

Module 3

Remote sensing of land, soil and vegetation: Analysis of land surface biophysical properties, land surface temperature, classification of land use and land cover-supervised and unsupervised techniques, change detection, development of terrain models-DEM &DTM, soil type and soil moisture monitoring, vegetation indices, classification of vegetation using satellite data, detection of biomass burning

Module 4

Atmospheric remote sensing: Interaction of EM radiations with aerosols and gases- scattering, absorption and extinction, radiative transfer models and retrieval algorithms, aerosol optical depth, air

quality monitoring using satellite data, LIDAR measurement of atmospheric profiles, meteorological monitoring and forecast

Module 5

Remote sensing of water resources: Mapping water resources- surface and groundwater, watershed health assessment, water quality monitoring, flood monitoring, ocean monitoring, aquatic biodiversity mapping, oil spill detection

Text Books:

1. Lillesand T.M. and Kiefer R.W., Remote sensing and image interpretation, Second Edition, John Wiley and Sons, 1987.
2. George Joseph and Jeganathan C., Fundamentals of remote sensing, 3rd Edition, University Press

References:

1. Manual of Remote Sensing, American Society of Photogrammetry and Remote Sensing, 1993.
2. Paul Curran P.J., Principles of Remote Sensing, ELBS, 1983.
3. Sabins F.F. Jr., Remote Sensing Principles and Interpretation, W.II. Freeman and Company, 1978.
4. Martin, R.V., Satellite remote sensing of air quality, Atmospheric Environment, Vol 42(34), pp 7823-7843, 2008.
5. Hamlyn G Jones and Robin A Voughan, Remote sensing of vegetation: Principles, Techniques, and applications, Oxford University Press, 2010.
6. Seelye Martin, An introduction to ocean remote sensing, Cambridge University Press, 2014
7. Ravi Sankar Dwivedi, Remote sensing of soils, Springer, 1st Edition, 2017.
8. Prasad S., and Thenkabail, Remote sensing of water resources, disasters and urban studies, CRC Press, 2019.

Course Contents and Lecture Schedule

Module	Topic	Course Outcomes addressed	No. of Lectures
1	Module 1: Total Lecture Hours -7		
1.1	Physics of remote sensing, interaction of earth surface features with electromagnetic radiations	CO1	2
1.2	atmospheric windows, effects of atmosphere, spectral signatures	CO1	2
1.3	Types of remote sensing, active and passive measurements	CO1	1
1.4	Platform characteristics, satellite orbits	CO1	1
1.5	Some popular satellite sensors-Landsat, MODIS, Sentinel, SCATSAT and INSAT3D R	CO3	1
2	Module II: Total Lecture Hours- 7		
2.1	Sensor characteristics-spatial, temporal, spectral, radiometric resolutions	CO2	1
2.2	Principles of image processing, methods of encoding image data-BIL, BIP, BSQ, False Color Composite (FCC),	CO2	2
2.3	Elements of visual image interpretation	CO2	1
2.4	Image correction techniques- atmospheric, geometric and radiometric, Principles of photogrammetry	CO2	2
2.5	Algorithms and data products	CO3	1
3	Module III: Total Lecture Hours-7		
3.1	Analysis of land surface biophysical properties, land surface temperature, classification of land-use and land cover-supervised and unsupervised techniques, change detection	CO4	3
3.2	Development of terrain models-DEM &DTM	CO4	1
3.3	Soil type and soil moisture monitoring	CO4	1
3.4	Vegetation indices, classification of vegetation using satellite data	CO4	1

3.5	Detection of biomass burning	CO4	1
4	Module IV: Total Lecture Hours- 7		
4.1	Interaction of EM radiations with aerosols and gases- scattering, absorption and extinction	CO4	1
4.2	Radiative transfer models and retrieval algorithms	CO3	2
4.3	Aerosol optical depth, air quality monitoring using satellite data	CO4	2
4.4	LIDAR measurement of atmospheric profiles	CO3	1
4.5	Meteorological monitoring and forecast	CO4	1
5	Module V: Total Lecture Hours- 7		
5.1	Mapping water resources- surface and groundwater	CO4	1
5.2	Watershed health assessment, water quality monitoring, flood monitoring	CO4	3
5.3	Ocean monitoring, aquatic biodiversity mapping	CO4	2
5.4	Oil spill detection	CO4	1



Model Question Paper

Reg No.: _____

Name: _____

APJ ABDUL KALAM TECHNOLOGICAL UNIVERSITY
EIGHTH SEMESTER B.TECH DEGREE EXAMINATION

Course Code: CET466

Course Name: ENVIRONMENTAL REMOTE SENSING

Max. Marks: 100

Duration: 3 Hours

Part A

(Answer all questions; each question carries 3 marks)

1. What are atmospheric windows?
2. How spectral signature is useful in remote sensing?
3. Explain False Colour Composite image.
4. What is sensor revisit time?
5. What is NDVI?
6. Explain how land use changes can be detected through remote sensing.
7. What is aerosol optical depth?
8. How wind scatterometers work?
9. Explain principle of groundwater remote sensing.
10. How oil slick thickness is monitored by remote sensing?

PART B

(Answer one full question from each module, each question carries 14 marks)

11. (a) Discuss in detail types of satellite sensors. Name any three operational satellite sensors and describe which type they are. (9 Marks)
 - (b) Explain the effects of atmosphere on remote sensing data. (5 Marks)
- OR
12. (a) Compare active and passive remote sensing. (5 Marks)
 - (b) Discuss various types of platforms used in remote sensing. (5 Marks)
 - (c) Explain types of satellite sensors based on the orbit. (4 marks)
13. (a) Discuss various sensor parameters. (9 Marks)
 - (c) What is BIP format? (5 Marks)

OR

14. (a) Discuss various correction techniques applied to a satellite imagery. (9 Marks)
(b) What is a data product? (5 Marks)

15. (a) Explain the techniques for classification of land use data. (9 Marks)
(b) How soil moisture is detected in satellite remote sensing? (5Marks)

OR

16. (a) How fire pixels detection algorithms work? (7 Marks)
(b) What is DEM? How is it developed? (7 Marks)

17. (a) Aerosol optical depth may not be a suitable surrogate for surface level particulate pollution. Discuss (5 Marks)
(b) Explain the principle of wind measurement using satellite sensors. (5 Marks)
(c) Weather forecasts have become more reliable with the availability of satellite sensors. Discuss. (4 Marks)

OR

18. (a) Discuss the challenges and opportunities in air quality remote sensing. (9 Marks)
(b) How LIDARs are useful in air quality monitoring? (5 Marks)
19. (a) Discuss how health of a watershed can be assessed through remote sensing. (8 Marks)
(b) Explain the principle of remote sensing of water quality. (6 Marks)

OR

20. (a) Explain how remote sensing is useful in flood monitoring. (7 Marks)
(b) Discuss how remote sensing play a significant role in ocean monitoring. (7 Marks)

CET476	BUILDING SERVICES	CATEGORY	L	T	P	CREDIT	YEAR OF INTRODUCTION
		PEC	3	0	0	3	2019

Preamble: The course aims to provide a basic understanding about the various building services and enable the students to apply them in building planning and construction

Pre-requisite: CET 304 Environmental Engineering

Course outcomes: After the completion of the course, the student will be able to

Course outcome	Description
CO 1	Recommend appropriate water management services
CO 2	Develop a system for the management of waste
CO 3	Identify suitable electrical and mechanical building services
CO 4	Recall the various firefighting services
CO 5	Choose relevant materials and practices for good acoustics
CO 6	Propose sustainable construction materials, methods, and practices

Mapping of course outcomes with program outcomes:

	PO1	PO2	PO3	PO4	PO5	PO6	PO7	PO8	PO9	PO10	PO11	PO12
CO1	3	3	1				2				1	
CO2	2	3	1				1				1	
CO3	2											
CO4	2					2						
CO5	3	3									3	
CO6	2					2	3				2	

Assessment pattern:

Bloom's Category	Continuous Assessment Tests		End Semester Examination (Marks)
	Test 1 (Marks)	Test 2 (Marks)	
Remember	10	15	20
Understand	15	20	20
Apply	10	10	40
Analyse	5	5	10
Evaluate	5		5
Create	5		5

Mark distribution

Total marks	CIE	ESE	ESE Duration
150	50	100	3 Hrs

Continuous Internal Evaluation Pattern:

Attendance: 10 Marks

Continuous Assessment Test (2 numbers): 25 Marks

Assignment/Quiz/Course project: 15 Marks

End Semester Examination Pattern:

There will be two parts; Part A and Part B. Part A contains 10 questions with 2 questions from each module, having 3 marks for each question. Students should answer all questions. Part B contains 2 questions from each module of which student should answer any one question completely. Each question can have maximum 2 sub-divisions and carry 14 marks.

Syllabus**Module I****Water management services**

Pipes for water distribution, joints, fixtures and valves, water meters, etc. - Water storage tanks: capacity and location - water purifiers

Terminology such as flow, pressure, head, etc. - principles of water supply in buildings (low-rise, multi-storeyed)

Rain water Harvesting - roof top harvesting, type of spouts, sizes of rainwater pipes, methods of rain water harvesting – harvesting tanks and pit - typical details

Module II**Liquid and solid waste management services**

Types of traps and chambers: inspection chamber, disconnecting chamber, intercepting trap, S-trap, P-trap, gully trap, grease trap - sanitary fixtures: washbasins, WCs, bathtubs, urinals, flushing cistern - Types of pipes and joints.

Design principles of sanitary layout: location and ventilation of chambers, traps, fixtures - Building sanitation systems: separate, combined, single stack, one pipe and two pipe - On-site treatment: Septic tanks, Soak pits, Cess pools, dispersion trenches – decentralized treatment systems for multi-storeyed buildings (theory only, no design) - recycling grey water: practices

Solid waste quantity, Types and composition, characteristics, on-site processing and disposal methods

Module III

Electrical and Mechanical services

Electrical installations and Accessories of wiring (terminologies and symbols only), Systems of wiring, Electrical layout for residence, small workshop, show room, school building, etc.

Air Conditioning: Types of Air Conditioners, (Central type, Window Type, Split Unit), capacity selection of air conditioner

Lift: Definition, Types of Lifts, Location, Sizes, Component parts - Elevators & Escalators: Different types of elevators and Escalators, Freight elevators, Passenger elevators, Hospital elevators - Uses of different types of elevators – Escalators – Dumbwaiters: Types and uses - Conveyors: Types and uses.

Pumps – Types, Selection, installation, and maintenance

Module IV

Fire and Acoustic management services

Causes and Effects of fire, General Requirements of Fire Resisting building as per IS and NBC 2005, Characteristics of Fire resisting materials, Maximum Travel Distance, Fire Fighting Installations for Horizontal Exit, Roof Exit / Fire Lifts, External Stairs - Firefighting equipment and different methods of fighting fire, means of escape, alarms, etc

Requirement of good Acoustic - Factors to be followed for noise control in residential building - Acoustical Materials: Porous materials, panel absorbers, membrane absorbers, acoustical plasters, diffusers, cavity or Helmholtz resonators. Role of functional absorbers, Adjustable acoustics and variable sound absorbers. Acoustical correction and retrofits to existing spaces

Module V

Miscellaneous services

Concept of Green buildings – Sustainable features of Green building – LEED India rating system - energy efficiency, water efficiency – Green materials and equipment - waste reduction during construction, materials with recycled content, local materials, material reuse, certified wood, Rapidly renewable building materials and furniture, HVAC

Concept of building automation - Design issues related to building automation and its effect on functional efficiency, Components of building automation system; modern security system, alarm system, fire-protection, inter- communication, monitoring devices, mechanical means of vertical and horizontal transportation, Intelligent lighting system etc.

Text/Reference books

1. Birdie, G. S., and Birdie, J. S., Water Supply and Sanitary Engineering, Dhanpat Rai and Sons, New Delhi, 2007.
2. Duggal, K. N., Elements of Environmental Engineering, S Chand and Co. Ltd., New Delhi, 2008.
3. Modi, P. N., Sewage Treatment and Disposal and Wastewater Engineering, Standard Book House, New Delhi, 2008
4. Rainwater harvesting and conservation manual, CPWD, GOI, 2002
5. K B Raina and S K Bhattacharya, Electrical design estimating and costing, New age international pvt. Ltd publishers, 2005
6. Arora C.P, Refrigeration and Air Conditioning, Tata McGraw Hill, 2000
7. Charles J Kibert, Sustainable construction – Green building design and delivery, Wiley, 2016
8. E F Curd and C A Howard, Introduction to building services, Macmillan, 1996
9. Chadderton DV, Building services engineering, Taylors & Francis Group

Course Contents and Lecture Schedule

Module	Contents	Outcomes addressed	Hours
1	Module 1		5
1.1	Pipes for water distribution, joints, fixtures and valves, water meters, etc	CO 1	1
1.2	Water storage tanks: capacity and location - water purifiers	CO 1	1
1.3	Terminology such as flow, pressure, head, etc. - principles of water supply in buildings (low-rise, multi-storeyed)	CO 1	1
1.4	Rainwater Harvesting - roof top harvesting, type of spouts, sizes of rainwater pipes	CO 1	1
1.5	Methods of rainwater harvesting – harvesting tanks and pit - typical details	CO 1	1
2	Module 2		8
2.1	Types of traps and chambers: inspection chamber, disconnecting chamber, intercepting trap, S-trap, P-trap, gully trap, grease trap	CO 2	1
2.2	sanitary fixtures: washbasins, WCs, bathtubs, urinals, flushing cistern - Types of pipes and joints.	CO 2	1
2.3	Design principles of sanitary layout: location and ventilation of chambers, traps, fixtures	CO 2	1
2.4	Building sanitation systems: separate, combined, single stack, one pipe and two pipe	CO 2	1

2.5	On-site treatment: Septic tanks, Soak pits, Cess pools, dispersion trenches	CO 2	1
2.6	Decentralized treatment systems for multi-storeyed buildings (theory only, no design)	CO 2	1
2.7	Practices for Recycling grey water	CO 2	1
2.8	Solid waste quantity, Types and composition, characteristics	CO 2	
2.9	On-site processing and disposal methods	CO 2	1
3	Module 3		7
3.1	Electrical installations and Accessories of wiring (terminologies and symbols only), Systems of wiring	CO 3	1
3.2	Electrical layout for residence, small workshop, show room, school building, etc.	CO 3	1
3.3	Air Conditioning: Types of Air Conditioners, (Central type, Window Type, Split Unit), capacity selection of air conditioner	CO 3	1
3.4	Lift: Definition, Types of Lifts, Location, Sizes, Component parts	CO 3	1
3.5	Different types of elevators and Escalators, Freight elevators, Passenger elevators, Hospital elevators - Uses of different types of elevators	CO 3	1
3.6	Escalators – Dumbwaiters: Types and uses -Conveyors: Types and uses.	CO 3	1
3.7	Pumps – Types, Selection, installation, and maintenance	CO 3	1
4	Module 4		7
4.1	Causes and Effects of fire, General Requirements of Fire Resisting building as per IS and NBC 2005	CO 4	1
4.2	Characteristics of Fire resisting materials, Maximum Travel Distance, Fire Fighting Installations for Horizontal Exit, Roof Exit / Fire Lifts, External Stairs	CO 4	1
4.3	Firefighting equipment and different methods of fighting fire, means of escape, alarms, etc	CO 4	1
4.4	Requirement of good Acoustic - Factors to be followed for noise control in residential building	CO 5	1
4.5	Acoustical Materials: Porous materials, panel absorbers, membrane absorbers, acoustical plasters, diffusers, cavity or Helmholtz resonators	CO 5	1
4.6	Role of functional absorbers, Adjustable acoustics and variable sound absorbers	CO 5	1

4.7	Acoustical correction and retrofits to existing spaces	CO 5	1
5	Module 5		8
5.1	Concept of Green buildings – Sustainable features of Green building	CO 6	1
5.2	LEED India rating system - energy efficiency, water efficiency	CO 6	1
5.3	Green materials and equipment - waste reduction during construction, materials with recycled content, local materials, material reuse, certified wood, Rapidly renewable building materials and furniture	CO 6	1
5.4	HVAC	CO 6	1
5.5	Concept of building automation - Design issues related to building automation and its effect on functional efficiency	CO 6	1
5.6	Components of building automation system; modern security system, alarm system, fire-protection, inter-communication, monitoring devices,	CO 6	1
5.7	Mechanical means of vertical and horizontal transportation,	CO 6	1
5.8	Intelligent lighting system	CO 6	1



APJ ABDUL KALAM
TECHNOLOGICAL
UNIVERSITY

SEMESTER VIII

PROGRAM ELECTIVE V



Assessment Pattern

Bloom's Category	Continuous Assessment Tests		End Semester Examination
	1	2	
Remember (K1)	5	5	10
Understand (K2)	10	10	20
Apply (K3)	20	20	40
Analyse (K4)	15	15	30
Evaluate (K5)	-	-	-
Create (K6)	-	-	-

Continuous Internal Evaluation pattern:

Attendance	:	10 marks
Continuous Assessment Tests	:	25 marks
Assignment/Quiz/Course project	:	15 marks
Total	:	50 marks

End Semester Examination Pattern: There will be two parts; Part A and Part B. Part A contain 10 questions with 2 questions from each module, having 3 marks for each question. Students should answer all questions. Part B contains 2 questions from each module of which student should answer any one. Each question can have maximum 2 sub-divisions and carry 14 marks.

Course Level Assessment Questions

(Questions may be framed based on the outline given under each course outcome)

Course Outcome 1 (CO1):

1. Demonstrate how D'Alembert's principle can be applied for setting up the equation of motion of SDOF systems.
2. Problems involving idealization of structures as equivalent SDOF systems and estimation of natural frequency.

Course Outcome 2 (CO2):

1. Problems involving estimation of dynamic response of structures idealized as SDOF systems
2. Explain the significance of frequency ratio (excitation to natural frequency) in dynamic response of structures.

Course Outcome 3 (CO3):

1. Problems involving development of equation of motions of 2 DOF systems or MDOF shear buildings

2. Problems involving estimation of natural frequencies and mode shapes of 2 DOF systems

Course Outcome 4 (CO4):

1. Discuss how the following irregularities influence the seismic behavior of buildings.
 - (i) Open ground stories
 - (ii) Torsional irregularities
2. Explain the seismic design philosophy followed by Indian standards.

Course Outcome 5 (CO5):

1. Give suitable explanation(s) for the following ductile detailing provisions of IS 13920 (2016) for seismic design of structures.
 - (i) At the joint face of a beam, the positive steel must be at least equal to half of the negative steel at that face.
 - (ii) The spacing of transverse reinforcement (rectangular hoops) in columns shall not exceed 300 mm. Also, the spacing of hoops shall not exceed half the least lateral dimension of the column.
2. Problems involving estimation of base shear and its distribution along height.

Syllabus

Module I (7 Hours)

Overview of structural dynamics: Fundamental objective of dynamic analysis- classification of dynamic loads – essential characteristics of a dynamic problem – methods of discretization – lumped mass procedure – generalized displacements – single degree of freedom system – basic components of a dynamic system.

Formulation of equation of motion – Newton's 2nd law and D'Alembert's principle; influence of gravitational forces – generalized SDOF systems.

Module II (7 Hours)

Solution of the equation of motion – undamped free vibration – damped free vibration- critically damped under damped and over damped SDOF systems, Logarithmic decrement.

Response to harmonic loading – transient and steady state response of undamped and damped SDOF systems – dynamic amplification factor, force transmissibility and vibration isolation.

Module III (7 Hours)

Response to periodic loading – Fourier series representation of periodic loads. Response of SDOF systems.

Base excited SDOF system - formulation of equation of motion – Response of SDOF base excited systems; Concept of pseudo acceleration, velocity. Response spectra, Four way logarithmic plot – DVA spectrum (concept only).

Two degree of freedom systems – Formulation of equations of motion – free vibration analysis – frequencies and mode shapes – orthonormalization of modes.

Module IV (6 Hours)

Lumped mass modelling of MDOF systems - Shear building; free vibration analysis – frequencies and mode shapes; Modal expansion of response, Mode superposition technique (concept only).

Introduction to engineering seismology – Plate tectonics – faults – causes of earthquake – energy release – seismic waves - Intensity and Magnitude of earthquake ; Measurement of ground motion-Seismographs, Characteristics of ground motion; Seismic zones in India.

Module V (7 Hours)

Behaviour of buildings under earthquakes – factors influencing structural performance – building configuration, strength, stiffness and ductility; effects of structural irregularities on building performance.

Estimation of Seismic Demand –Seismic zones and coefficients; response reduction factors, Estimation of base shear and its distribution along height based on Equivalent static method using IS 1893 for multi storied buildings.

Ductility considerations in earthquake resistant design of buildings – Impact and requirements for ductility – factors affecting ductility – ductile detailing considerations in buildings as per IS 13920

Text books / References

1. Mario Paz, “Structural Dynamics – Theory and Computations”, CBS Publishers, NewDelhi.
2. Chopra A.K., “Dynamics of Structures” 5th edition, Pearson Education, NewDelhi
3. Clough R.W. and Penzien, J., “Dynamics of Structures”, McGraw Hill International.
4. Humar J.L., “Dynamics of Structures” A.A. Balkema Publishers Tokyo.
5. Agarwal P., and Shrikhande, M., “Earthquake Resist Design of Structures”, PHI Learning Pvt. Ltd. NewDelhi.
6. Paulay T. and Priestley M.J.N., “Seismic Design of Reinforced Concrete and Masonry Buildings”, John Wiley & Sons Inc. NewYork.

7. IS: 1893(part I), (2016), *Indian Standard Criteria for Earthquake Resistant Design of Structures*, Bureau of Indian Standards, NewDelhi.
8. IS: 13920 (2016) *Indian Standard Code of Practice for Ductile Detailing of Reinforced Concrete Structures Subjected to Seismic Forces*, Bureau of Indian Standards, NewDelhi.

Course Contents and Lecture Schedule:

Module	Topic	Course outcome addressed	No. of Lectures
Module I (7 hours)			
1.1	Introduction: Fundamental objective of structural dynamic analysis; Types of prescribed loadings; Essential characteristics of a dynamic problem; Method of discretization - lumped mass procedure – generalized displacements.	CO1	2
1.2	Degree of freedom and stiffness – equivalent stiffness, Numerical examples.	CO1	1
1.3	Single degree of freedom system – Components of the basic dynamic system – formulation of the equation of motion – using Newton’s 2 nd law and D’Alembert’s principle. Influence of gravitational forces.	CO1	2
1.4	Systems modelled as rigid body assemblage-Numerical examples on formulation of equation of motion	CO1	1
1.5	Generalized SDF systems – expression for generalized system properties – Numerical examples.	CO1	1
Module II (7 hours)			
2.1	Free vibration of single degree of freedom system:- Solution of equation of motion for un-damped systems. Free vibration response of damped systems – critically damped and over damped systems.	CO2	2
2.2	Free vibration response of under-damped systems- Logarithmic decrement. Numerical examples on free vibration response of un-damped and damped systems.	CO2	1
2.3	Response of un-damped and damped SDF systems to harmonic excitation; Dynamic Amplification factor.	CO2	2
2.4	Numerical examples on harmonic excitation problems;	CO2	1

2.5	Force transmissibility and vibration isolation- numerical examples	CO2	1
Module III (7 hours)			
3.1	Response of SDF systems to periodic loading – Fourier series representation of periodic loading. Response of undamped and damped SDF systems to loads expressed as Fourier series expansion- Numerical examples	CO2	2
3.2	Base excited SDOF systems - formulation of equation of motion – Response of SDOF base excited systems- numerical examples	CO2	1
3.3	Concept of pseudo acceleration and velocity. Response spectra, Four way logarithmic plot – DVA spectrum (concept only).	CO2	2
3.4	Two degree of freedom systems – Formulation of equations of motion for simple 2 DOF systems – free vibration analysis – frequencies and mode shapes – orthonormalization of modes	CO3	2
Module IV (6 hours)			
4.1	Shear building – assumptions involved in idealization- equation of motion- free vibration analysis – frequencies and mode shapes.	CO3	2
4.2	Modal expansion of response, Mode superposition technique (concept only).	CO3	1
4.3	Introduction to engineering seismology – Plate tectonics – faults – causes of earthquake – energy release – seismic waves	CO4	2
4.4	Intensity and Magnitude of earthquake ; Measurement of ground motion-Seismographs, Characteristics of ground motion; Seismic zones in India.	CO4	1
Module V (6 hours)			
5.1	Behaviour of buildings under earthquakes – factors influencing structural performance – building configuration, strength, stiffness and ductility; effects of structural irregularities on building performance.	CO4	2
5.2	Estimation of Seismic Demand –Seismic zones and coefficients; response reduction factors, Estimation of base shear and its distribution along height based on Equivalent static method using IS 1893 for multi storied buildings	CO5	2

5.3	Ductility considerations in earthquake resistant design of buildings – Impact and requirements for ductility – factors affecting ductility – ductile detailing considerations in buildings as per IS 13920	CO5	2
-----	--	-----	---

Model Question paper

PAGES:2

Reg. .No: _____

Name: _____

**APJ ABDUL KALAM TECHNOLOGICAL UNIVERSITY
EIGHTH SEMESTER B. TECH DEGREE EXAMINATION,
MONTH & YEAR
Course Code: CET418**

Course Name: EARTHQUAKE RESISTANT DESIGN

Max. Marks: 100

Duration: 3 Hours

*(Use of IS:1893 (part I) 2016 permitted in exam hall)***PART A (3 x 10 = 30 Marks)****Answer all Questions. Each question carries 3 Marks**

- Briefly explain the various sources of dynamic excitation for engineering structures
- An unknown mass m kg attached to the end of a spring with unknown stiffness k has a natural frequency of 1.57 Hz. When a 0.453 kg mass is added to m , the natural frequency is lowered to 1.278 Hz. Determine the unknown mass m and the spring constant k N/m.
- Explain the terms (i) Dynamic amplification factor and (ii) Transmissibility ratio.
- A vibrating system consisting of a weight of $W = 4.54$ kg and a spring with stiffness $k = 3500$ N/m is viscously damped so that the ratio of two consecutive amplitudes is 1.00 to 0.85. Determine the logarithmic decrement.
- Write short note on (i) response spectrum and (ii) four way logarithmic plot.
- Write short note on mass orthonormalization.
- Set up the equation of motion for a 3 storey shear building with the following properties. Floor mass = M ; storey stiffness = K .
- List the two different kind of body waves and explain how they differ.
- Explain importance factor and response reduction factor in the context of earthquake response analysis.
- Briefly explain the factors which affect the ductility.

PART B (14 x 5 = 70 Marks)

Answer any one full question from each module. Each question carries 14 Marks

Module 1

11.

- a) Demonstrate how D'Alembert's principle can be applied for setting up the equation of motion of SDOF systems (4)
- b) Set up the equation of motion for the system shown in Fig 1 and hence determine its natural frequency (10)

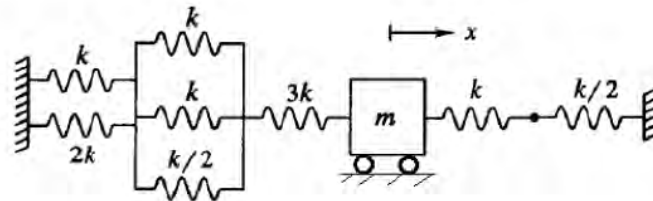

Fig. 1.

12. a) Explain distributed mass and lumped mass models in the context of system idealization for dynamic analysis. (4)
- b) A rigid uniform bar of mass m and length l is pinned at O and is supported by a spring and viscous damper as shown in Fig.2. Set up the equation of motion for small oscillations of the rod and hence determine its undamped natural frequency (10)

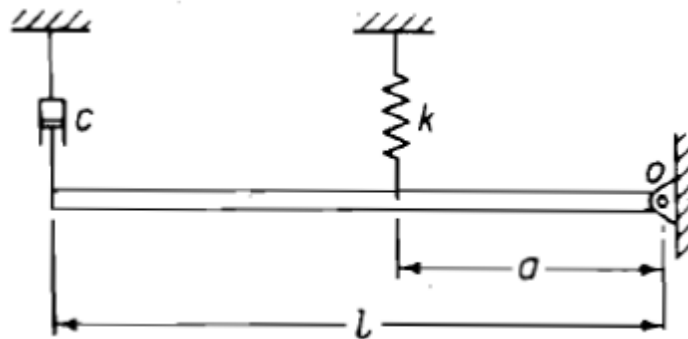

Fig.2.

Module 1I

13. a) Explain logarithmic decrement and its practical significance (4)
- b) A one storey building is idealized as a rigid girder supported by weightless columns as shown in Fig. 3. In order to evaluate the dynamic properties of this structure, a free

vibration test is made, in which the roof system is displaced laterally by a hydraulic jack and then released. During the jacking operation, it is observed that a force of 90kN is required to displace the roof system by 0.51 cm. After the instantaneous release of this initial displacement, the maximum displacement on the return swing is only 0.406 cm and the period of this displacement cycle is $T = 1.4$ s. (10)

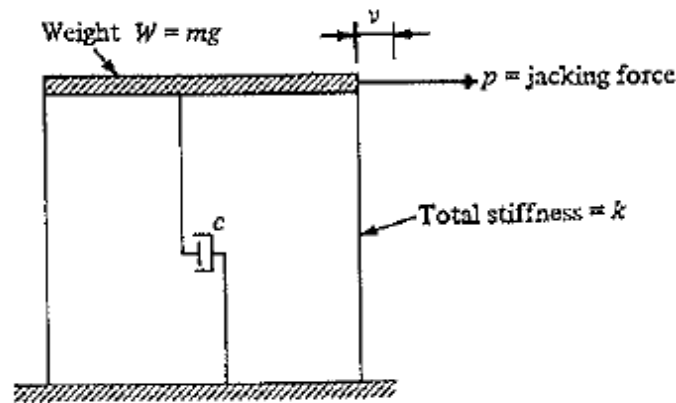

Fig.3

14. a) Write short notes on force transmissibility and vibration isolation (4)

b) A 50 kg turbine is mounted on four parallel springs, each of stiffness 3×10^5 N/m. When the machine operates at 40 Hz, its steady-state amplitude is observed as 1.8 mm. Compute the magnitude of the excitation? (10)

Module III

15. a) Briefly explain how a periodic loading can be expressed as an infinite series of harmonic functions using Fourier theorem. (4)

b) A single bay single storey portal frame with the following properties is subjected to a ground acceleration history that can be idealized as $0.5 \sin(15t)$. find the peak steady state amplitude of floor vibration and column shear if the floor mass is 4540 kg and 2013 kN/m. (10)

16. a) Write short notes on the following (i) Pseudo acceleration (ii) DVA spectrum (4)

b) Setup the equations of motion for the 2 DOF system shown in Fig.4. and hence estimate its natural frequencies. Following data may be utilized. $m_1 = m_2 = M$; and $k_1 = k_2 = K$. (10)

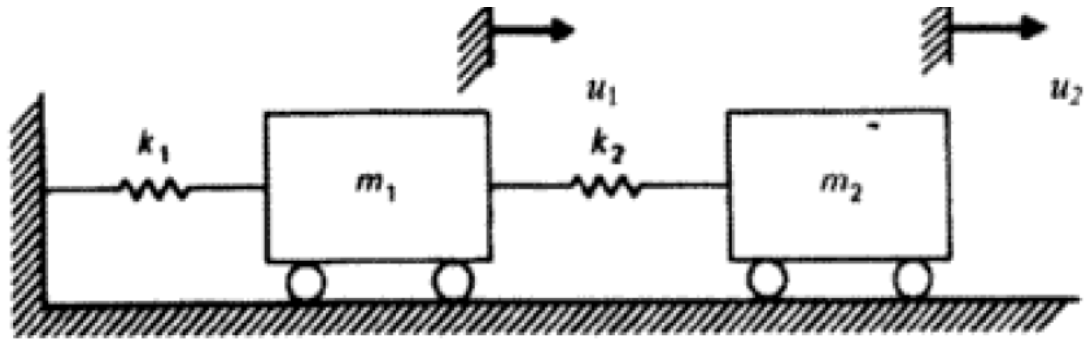

Fig.4.

Module 1V

17. a. What is a shear building? List the assumptions made in the lumped mass idealization of shear buildings? (4)

b. For the two storey shear building with floor mass and storey shears as shown in Fig.5. set up the equation of motion and hence determine its natural frequencies and vibration modes (10)

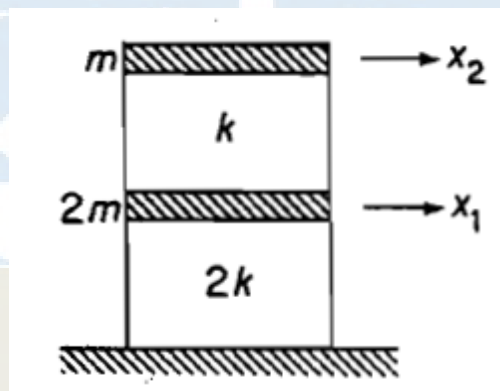

Fig.5.

18. a. Explain mode superposition technique for the estimation of vibration response of multi degree of freedom systems (6)

b) Distinguish between the following

- (i) Body waves and Surface waves (ii) Rayleigh waves and love waves (iii) intensity and magnitude of earthquakes. (8)

Module V

19. a) Explain how the various building irregularities affect the behaviour of structures to earthquake excitation. (6)

b) The plan of a five storey building is shown in Fig 6. Dead load including self weight of slabs, finishes, partitions etc can be assumed as 5 kN/m^2 and live load as 4 kN/m^2 on each floor and as 1.5 kN/m^2 on the roof. Determine the base shear and shears at different storey levels for the frame 1-1 marked in figure. (8)

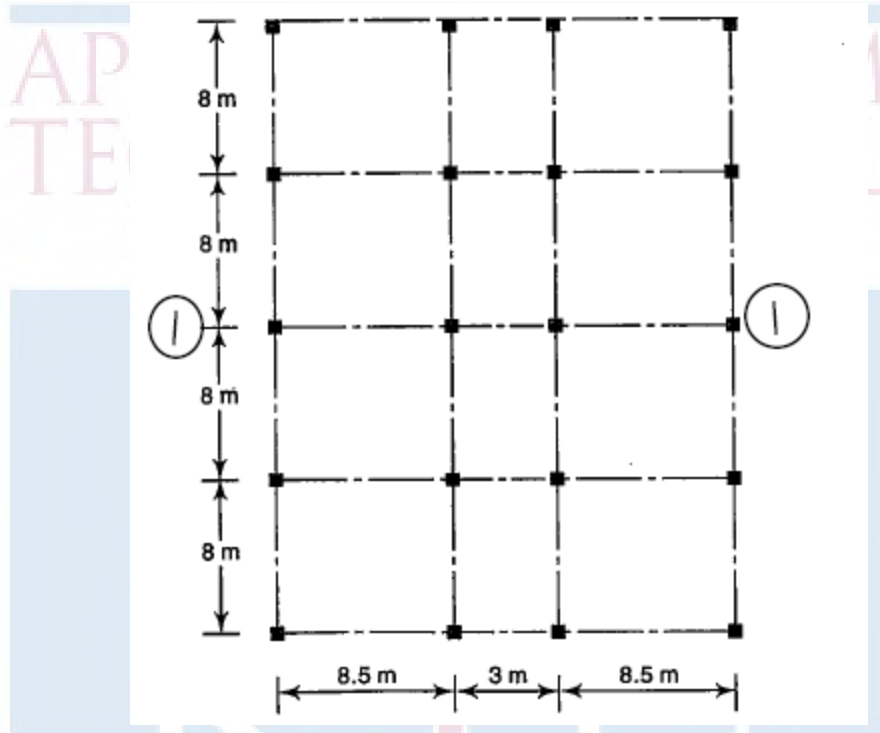

Fig.6.

20. a) Explain the seismic coefficient method for seismic analysis of the structures. (6)
- b) (i) Discuss on the significance of ductility in seismic design. (4)
- (ii) Briefly discuss the various ductile detailing provisions in IS 13920 for beams (4)

CET428	SOIL STRUCTURE INTERACTION	CATEGORY	L	T	P	CREDIT	YEAR OF INTRODUCTION
		PEC	3	0	0	3	2019

Preamble: This course introduces the importance of behaviour and analysis of structures while interacting with soil. The actual behaviour of structures with respect to foundation and behaviour of foundation with respect to soil are studied considering different models. This knowledge will be helpful for economising the foundation size and to understand the complex behaviour of soil under particular situation.

Prerequisite: CET204 Geotechnical Engineering 1/ CET305 Geotechnical Engineering II / CET302 Structural Analysis II

Course Outcomes : After the completion of the course the student will be able to:

CO 1	Explain elastic soil behavior related to bearing capacity and settlement
CO 2	Identify the significance of SSI in foundation design
CO 3	Explain various soil idealizations for SSI
CO 4	Apply the mathematical models for 1- Dimensional soil structural analysis
CO 5	Apply SSI for general engineering design problems

Mapping of course outcomes with program outcomes

	PO1	PO2	PO3	PO4	PO5	PO6	PO7	PO8	PO9	PO10	PO11	PO12
CO 1	3	2	2									2
CO 2	3	4	3									
CO 3	2	3	3									
CO 4	3	3	3									
CO 5	3	2	2									2

Assessment Pattern

Bloom's Category	Continuous Assessment Tests		End Semester Examination
	1	2	
Remember (K1)	5	5	10
Understand (K2)	10	10	20
Apply (K3)	20	20	40
Analyse (K4)	15	15	30
Evaluate (K5)	-	-	-
Create (K6)	-	-	-

Continuous Internal Evaluation pattern:

Attendance	:	10 marks
Continuous Assessment Tests	:	25 marks
Assignment/Quiz/Course project	:	15 marks
Total	:	50 marks

End Semester Examination Pattern: There will be two parts; Part A and Part B. Part A contain 10 questions with 2 questions from each module, having 3 marks for each question. Students should answer all questions. Part B contains 2 questions from each module of which student should answer any one. Each question can have maximum 2 sub-divisions and carry 14 marks.

Syllabus**MODULE I:****Soil bearing capacity: (7 Hours)**

Bearing capacity analysis by Terzaghi's theory, Skempton, Meyerhof and IS code method. Types of settlement for soil – immediate or elastic settlement, primary consolidation settlement, secondary compression settlement. Settlement calculation for granular and clayey soils based on IS code method.

MODULE II:**Fundamentals of Soil-Structure Interaction: (7 Hours)**

Introduction to soil-structure interaction– significance of SSI. Contact pressure distribution beneath rigid and flexible footings-cohesive and non-cohesive soils, concept of subgrade modulus-influencing factors, concentrically and eccentrically loaded cases - Static and Dynamic loading effects-static & dynamic SSI (concept only).

MODULE III:**Elastic models for soil response: (7 Hours)**

Winkler model, Elastic continuum models – isotropic elastic continuum, layered & structured elastic media, Two parameter elastic models – Filonenko-Borodich, Hetenyi and Pasternak models. Elastic -Plastic behaviour – Time dependent behaviour.

MODULE IV:**Beams on Elastic Foundations: (7 Hrs)**

Infinite beams resting over Winkler medium – governing differential equation, solutions for the case of infinite beams subjected to concentrated forces and uniform force of finite length.

Finite beams resting over Winkler medium- Hetenyi's principle of superposition. Classification of finite beams in relation to their stiffness.

MODULE V:

Applications of SSI in engineering design (7 Hrs)

Soil-structure interactions effects in design of isolated and mat foundations. Soil-structure interaction effects in vertical and lateral pile capacities.

Dynamic soil structure interaction – Applications in Low rise residential buildings, multi-storey buildings, bridges, dams, nuclear power plants.

Text Books

1. Selvadurai, A.P.S., Elastic Analysis of Soil Foundation Interaction, Elsevier, 1979.
2. Structure Soil Interaction- The real behaviour of Structures, Institution of structural Engineers, London, 1989.
3. Hemsley, J.A., Elastic Analysis of Raft Foundations, Thomas Telford, 1998
4. Nainan P. Kurian, Design of Foundation Systems, Narosa, 2005
5. Murthy, V.N.S., Advanced Foundation Engineering, CBS Publishers, New Delhi, 2007.
6. Cakmak, A.K., Soil-Structure Interaction ,Developments in Geotechnical Engineering 43, Elsevier and Computational Mechanics Publications, 1987.
7. Kramer,S.L.,Geotechnical-Earthquake Engineering, Pearson Education, 1996.
8. Hall, W,S., Oliveto Kluwer,O., Boundary Element Method for Soil-Structure Interaction , Academic Publishers, 2003.
9. Wolf, J.P., Dynamic Soil-Structure Interaction , Prentice-Hall, 1985.

Reference Books

1. Wolf, J.P.,Soil-Structure Interaction in the Time-Domain, Prentice-Hall, 1988.
2. Chen, Wai-Fah, Duan Lian, Bridge Engineering Seismic Design, CRC Press, 2003.

Course Contents and Lecture Schedule:

Module	Topic	Course outcome addressed	No. of Lectures
Module I (7 hours)			
1.1	Bearing capacity analysis by Terzaghi's theory, Skempton, Meyerhof and IS code method	CO1, CO2	2
1.2	Types of settlement for soil – immediate or elastic settlement, primary consolidation settlement, secondary compression settlement.	CO1, CO2	2
1.3	Settlement calculation for granular and clayey soils based on IS code method	CO1, CO2	2
1.4	Review Problems	CO1, CO2	1
Module II (7 hours)			
2.1	Introduction to soil-structure interaction– significance of SSI..	CO1, CO2	1
2.2	Contact pressure distribution beneath rigid and flexible footings-cohesive and non-cohesive soils- Problems	CO1, CO2	2
2.3	concept of subgrade modulus-influencing factors, concentrically and eccentrically loaded cases	CO1, CO2	2
2.4	Static and Dynamic loading effects-static & dynamic SSI (concept only)	CO1, CO2	2
Module III (7 Hours)			
3.1	Winkler model, Elastic continuum models – isotropic elastic continuum, layered & structured elastic media,	CO3	2
3.2	Two parameter elastic models – Filonenko-Borodich, Hetenyi and Pasternak models.	CO3	3
3.3	Elastic -Plastic behaviour	CO3	1
3.4	Time dependant behaviour	CO3	1
Module IV (7 Hours)			

4.1	Infinite beams resting over Winkler medium – governing differential equation, solutions for the case of infinite beams subjected to concentrated forces and uniform force of finite length.	CO4	4
4.2	Finite beams resting over Winkler medium- Hetenyi's principle of superposition. Classification of finite beams in relation to their stiffness.	CO4	4
Module V (7 Hours)			
5.1	Soil-structure interactions effects in design of isolated and mat foundations	CO5	1
5.2	Soil-structure interaction effects in vertical and lateral pile capacities.	CO5	1
5.3	Dynamic soil structure interaction – Applications in Low rise residential buildings	CO5	2
5.4	Dynamic soil structure interaction – Applications in multi storey buildings.	CO5	2
5.5	Dynamic soil structure interaction – Applications in bridges, dams, nuclear power plants.	CO5	1



CET438	AIRPORT, SEAPORT AND HARBOUR ENGINEERING	CATEGORY	L	T	P	CREDIT	YEAR OF INTRODUCTION
		PEC	3	0	0	3	2019

Preamble : Objective of the course is to introduce the principles of planning design and practice of Airport, Sea port and Harbor Engineering.

Prerequisite: Nil

Course Outcomes: At the end of the course, students will be able to

CO 1	Explain the basic principles of planning and design for site selection, Airport components based on air traffic characteristics
CO 2	Explain the basic design principles of Runway orientation, basic runway length and corrections required, Geometric design of runways, Design of taxiways and aprons, Terminal area planning,
CO 3	Explain various aspects such as Airport markings, Lighting of runway approaches, taxiways and aprons, Air traffic control methods.
CO 4	Explain the basic principles ,site selection characteristics ,lay out ,break waters, quays, piers, wharves, jetties, transit sheds and warehouses - navigational aids - light houses, signals - types - Moorings
CO 5	Explain the basics of Docks – Functions and types - dry docks, wet docks arrangement of basins and docks

Mapping of course outcomes with program outcomes

	PO1	PO2	PO3	PO4	PO5	PO6	PO7	PO8	PO9	PO10	PO11	PO12
CO 1	3	3	3	1		1	3	1		2		1
CO 2	3	1	3	1		1	1	1		1		1
CO 3	3	2	2	1					1	2		2
CO 4	2						2	1				2
CO 5	3	3	3			3		2				

Assessment Pattern

Bloom's Category	Continuous Assessment		End Semester Examination (marks)
	Test 1 Marks	Test 2 Marks	
Remember	7.5	7.5	30
Understand	7.5	7.5	30
Apply	5	5	20
Analyse	5	5	20
Evaluate			
Create			

Mark Distribution

Total Marks	CIE (Marks)	ESE (Marks)	ESE Duration
150	50	100	3 hours

Continuous Internal Evaluation Pattern:

Attendance	: 10 marks
Continuous Assessment Test (2 numbers)	: 25 marks
Assignment/Quiz/Course Project	: 15 marks

End Semester Examination Pattern:

The question consists of two parts- Part A and Part B. Part A consists of 10 questions with 3marks for each (two questions from each module). Part B consists of two questions from each module, out of which one has to be answered. Each question carries 14 marks and can have maximum 2 subdivisions.

Sample Course Level Assessment Questions:**Course Outcome 1 (CO1):**

Explain the basic principles to be followed for selection of sites and planning of Airport. Explain the various air traffic characteristics and standards as per ICAO and FAA

Course Outcome 2 (CO2):

Apply the basic principles to be followed for runway orientation and design. Explain the various types' correction to be applied for runway design.Solve Problem related to application of correction like temperature, altitude

Course Outcome 3 (CO3):

Elaborate the principles and functions and working of airport markings and lighting. Different means of air traffic control.

Course Outcome 4 (CO4):

Explain the function and design aspects of marine structures like break waters, quays, piers, wharves, jetties and functions and working of different types of navigational aids

Course Outcome 5 (CO5):

Discuss the principles, types, design considerations, functions and working of wet and dry Docks

Syllabus

Module	Contents	Hours
I	Introduction to Airport Engineering , Components of airport, selection of site for airport. Requirements of an ideal airport layout. Aircrafts and its characteristics, airport classifications as per ICAO. Location and planning of airport as per ICAO and F.A.A. recommendations, airport Elements -airfield, terminal area,	8
II	Run Way Design- Wind rose diagram and orientation of runway, wind coverage and crosswind component, factors affecting runway length, basic runway length, and corrections to runway length, runway geometrics and runway patterns (configurations). Design of taxiways and aprons, Terminal area planning, obstructions, approach zone, zoning laws, airport capacity, airport size (introduction only)	8
III	Introduction to Airport markings , Runway marking, Lighting of runway approaches, taxiways and aprons, Air traffic control-objectives, control system, control network-visual aids-landing information system,	5
IV	Harbours – Harbour components, ship characteristics, characteristics of good harbour, and principles of harbour planning, size of harbour, site selection criteria and layout of harbours, classification, features, requirements. Break waters quays, piers, wharves, jetties, transit sheds and warehouses - necessity and functions, classification. navigational aids - light houses, signals - types - Channel and entrance demarcation, buoys, beacons, light house communication devices	8

V	Docks – Functions and types - dry docks, wet docks-purpose, design consideration, operation of lock gates and passage, repair docks - graving docks, floating docks and repair of docks	7
---	--	---

Text Books

1. Khanna S K, Arora M G and Jain S S, “Airport Planning and Design”, Nemchand and Brothers, Roorkee, 2012.
2. Bindra S P, “A Course in Docks and Harbour Engineering”, Dhanpat Rai and Sons, New Delhi, 2013
3. Rangwala S C “Airport Engineering”, Charotar Publishing company 16 e, 2016.
4. Rangwala, “Harbor Engineering”, Charotar Publishing House, 2013.
5. Oza.H.P. and Oza.G.H., “A course in Docks & Harbour Engineering”. Charotar Publishing Co., 2013
6. Srinivasan R. “ Harbour,Dock and Tunnel Engineering”, 28th Edition
7. G.V. Rao Airport Engineering Tata McGraw Hill Pub. Co.

References

1. Horonjeff R. and McKelvy, F., Planning and Design of Airports, McGraw Hill, 5e, 2010

Course Content and lecture Schedule:

No.	Topic	Course Outcome	No. of Hr
1	Module 1		Total:8
1.1	Introduction, air port components, site selection	CO1	3
1.2	Requirements of an ideal airport layout. Aircrafts and its characteristics,	CO1	3
1.3	Airport classifications as per ICAO. Location and planning of airport, airport Elements -airfield, terminal area,	CO1	2
2	Module 2		Total: 8
2.1	Run Way Design- Wind rose diagram and orientation of runway, wind coverage and crosswind component	CO2	2
2.2	Factors affecting runway length, basic runway length, and corrections to runway length, runway geometrics and runway patterns (configurations).	CO2	3
2.3	Design of taxiways and Aprons, Terminal area planning,	CO2	1
2.4	Approach zone, zoning laws, airport capacity, airport size (introduction only)	CO2	2
3	Module 3		Total: 5
3.1	Introduction to Airport markings, Runway markings	CO3	1
3.2	Lighting of runway approaches, taxiways and aprons,	CO3	2
3.3	Air traffic control-objectives, control system, control network-visual aids-landing information system,	CO3	2
4	Module 4		Total: 8
4.1	Harbor Planning: Basic principles ,site selection characteristics	CO4	3
4.2	Classification, features, requirements. Of Break waters quays, piers, wharves, jetties, transit sheds and warehouses - necessity and functions, classification.	CO4	3

4.3	Navigational aids - light houses, signals - types - Channel and entrance demarcation, buoys, beacons, light house communication devices	CO4	2
5	Module 5		Total: 7
5.1	Functions -types and purpose of docks	CO5	2
5.2	Design considerations of docks	CO5	2
5.3	Operation of lock gates and passage, repair docks - graving docks, floating dock	CO5	3



Model Question Paper

**APJ ABDUL KALAM TECHNOLOGICAL UNIVERSITY
EIGHTH SEMESTER B. TECH DEGREE EXAMINATION, MONTH & YEAR**

Course Code: **CET 438**

Course Name: **AIRPORT, SEAPORT AND HARBOUR ENGINEERING**

Marks:100 Duration: 3 hrs

PART A

(Answer all questions. Each question carry three marks)

1. With a sketch, Describe aero plane components parts draw sketch.
2. Enumerate the various factors which would be kept in view while selecting Site for air port
3. What are functions of taxiways?
4. Explain the term wind rose Diagram
5. Give the classification of air traffic control systems .
6. Explain objectives of runway lightings
7. Define the following terms (1) Harbour, (2) Port, (3) Fenders,
8. (i) define terms:- tides, turning basin breakwater, draft
9. Why fenders are provided on docking platform? Draw the sketch of wooden and rubber fenders.
10. Differentiate between gravity docks and floating docks

PART B

(Answer one full question from each module)

11. a) Give the classification of airports as per I.C.A.O. & Enlist components of an airport 7
- b) Requirements of an ideal airport layout 7

OR

12. a) Explain the various factors to be considered for selection of site for airport. 7
- b) Explain the principles of planning of airport as per ICAO and F.A.A recommendations 7

13.a) The length of a runway under standard conditions is 1500m. The airport is to be provided at an elevation of 110m above mean sea level. The airport reference temperature is 32°C. Following data refers to the proposed longitudinal section of runway. Determine the corrected length of runway.

End to end of runway (m)	Grade (%)	End to end of runway (m)	Grade (%)
0 to 300	+1	1500 to 1800	+1
300 to 900	-0.2	1800 to 2100	-0.3
900 to 1500	+0.5		

14

OR

14. a) Explain by drawing sketch wind rose diagram type II showing direction, duration and intensity of wind. 7

b) What are the purposes of airport terminal building? Draw layout of airport terminal building 7

OR

15 a) Explain with sketches the various of Runway markings and salient features 7

b) List out the various visual aid visual aids-landing information system, Explain any one 7

OR

16a) what are the advantages lighting of runway approaches? 7

b) What are various control system, used in airports. 7

17 a) State the natural and meteorological phenomena a harbour engineer has to study and briefly mention the effects of these phenomena 14

OR

18a) What is breakwater? Explain design features of break water 6

b) Explain necessity and functions transit sheds and warehouses 8

19 a) Describe the working of a lock with sketches. 6

b) Explain with sketches the basic principle of gravity dock 8

OR

20 a) What are the various types of docks. Explain the primary functions of docks 10

b) draw sketch of floating Dock 4

Assessment pattern

Bloom's Category	Continuous Assessment Tests		End Semester Examination (Marks)
	Test 1 (Marks)	Test 2 (Marks)	
Remember	5	5	15
Understand	10	10	15
Apply	20	20	40
Analyze	15	15	30
Evaluate			
Create			

Continuous Internal Evaluation Pattern:

Attendance	:	10 Marks
Continuous Assessment Test (2 numbers)	:	25 Marks
Assignment/Quiz/Course project	:	15 Marks
Total	:	50 Marks

End semester examination pattern – There will be two parts; Part A and Part B. Part A contain 10 questions with 2 questions from each module, having 3 Marks for each question. Students should answer all questions. Part B contains 2 questions from each module of which student should answer any one. Each question can have maximum 2 sub-divisions and carry 14 Marks.

Course Level Assessment Questions

Q. No	Question	Marks	CO Assessed
	Part A (Answer ALL Questions)		
1	Differentiate weather and climate	3	CO1
2	Explain the forms of precipitation	3	CO1
3	Explain the laws of radiation	3	CO2
4	Explain temperature extremes and heat wave	3	CO2
5	Enlist the causes of floods	3	CO3
6	Differentiate Risk and reliability	3	CO1, CO2
7	Describe on IPCC Assessment reports	3	CO4

8	Enlist the methods of statistical downscaling	3	CO4
9	Explain change point in hydro-climatic series	3	CO5
10	Explain stationarity and non-stationarity of hydro-climatic data	3	CO5
Part B			
(Answer ANY ONE FULL question from each module)			
Module I			
11(a)	Explain the different types of clouds Explain the different types of clouds	8	CO1
11(b)	Explain the role of global climate oscillations on Indian monsoon rainfall	6	CO1
12 (a)	Differentiate ElNino and LaNina.	8	CO1
12 (b)	Explain the vapour pressure temperature relationship in the process of precipitation	6	CO1
13(a)	State the characteristics of Indian Monsoon	5	CO1
13 (b)	Explain in detail different types of precipitation	9	CO1
Module II			
14 (a)	Explain the vertical structure of atmosphere with relevant sketch	10	CO2
14 (b)	Explain thermal time	4	CO2
15 (a)	Differentiate Hadley cell and Ferrel cell	6	CO2
15 (b)	Explain the modeling of vertical variation in air temperature	8	CO2
16 (a)	Explain general circulation of atmosphere. Describe the triple cell general circulation model with the help of neat diagrams.	10	CO2
16(b)	Explain temporal variation of air temperature	4	CO2
Module III			
17 (a)	Explain the classification of droughts	8	CO3
17 (b)	Explain the methods of flood control	6	CO3
18 (a)	A cofferdam has been built to protect homes in a floodplain until a major channel project can be completed. The cofferdam was built for a 20-year flood event. The channel project will require 3years to complete. What are the probabilities that a) The cofferdam will not be overtopped during the 3 years ? b) The cofferdam will be overtopped in any one year? c) The cofferdam will be overtopped exactly once in 3 years? d) The cofferdam will be overtopped at least once in 3 years ?	10	CO3

	e) The cofferdam will be overtopped only in the third year?		
18 (b)	What are drought indices ? Enlist its different types	4	CO3
19(a)	Explain the method of estimation of any four types of drought indices	8	CO3
19 (b)	Explain Frequency analysis of hydro climatic extremes	6	CO3
Module IV			
20 (a)	Explain the causes of climate change	8	CO4
20 (b)	Differentiate statistical downscaling and dynamic downscaling	6	CO4
21 (a)	Explain (a) general circulation models (b) regional climate models	8	CO4
21 (b)	Explain the typical framework for modeling the impact of climate change on water resources	6	CO4
22 (a)	Explain the types of uncertainty in downscaling studies	6	CO4
22 (b)	Explain the salient features of most recent global climate data for downscaling studies	8	CO4
Module V			
23 (a)	Explain Principal component analysis	5	CO5
23 (b)	Explain any three methods for analyzing the trend of hydrologic data	9	CO5
24 (a)	Explain non-stationarity of hydroclimatic series	5	CO5
24 (b)	Explain any three methods of determination of change point of hydro-climatic series	9	CO5

Syllabus

Module I (8 Hours)

Introduction - weather and climate; hydrometeorology- variables affecting precipitation- humidity, vapor pressure, saturation vapor pressure–temperature relation (simple problems), perceptible water, forms and types of precipitation; cloud - types; Monsoon- characteristics of Indian summer monsoon rainfall- climate oscillations and Indian monsoon rainfall- ElNino and LaNina.

Module II (7 Hours)

Atmosphere- vertical structure; radiation and temperature; the general circulation of atmosphere- triple cell model, laws of radiation; temperature variation- modeling vertical variation and temporal variation of air temperature; temperature extremes; diurnal temperature range, heat waves- definition

Module III (8 Hours)

Climate variability and extremes: Floods- causes, types, methods of control, flood modeling (brief description only); Frequency analysis of extreme rainfall and flood-problems, Return period Risk and reliability in hydrologic design- simple problems; Droughts-types, characteristics and drought indices

Module IV (6Hours)

Climate change: Causes and effects of climate change, modeling of climate hydrologic impact of climate change on water resources-typical framework, general circulation models and regional climate models; Downscaling-concept and types; IPCC assessment reports, scenarios and database (brief description and salient features only), uncertainty in downscaling studies (brief description only)

Module V (6 Hours)

Statistical methods in hydro-climatology: principal component analysis and its use in climate change studies, methods for change point analysis, methods for trend analysis-statistical and graphical methods, stationary and non-stationary series- determination of non-stationarity of hydro-climatic series (no problems)

Text Book

1. G. S. Campbell, and J. M. Norman, An Introduction to Environmental Biophysics, Springer, 2013.

2. Rajib Maity, Statistical Methods in Hydrology and Hydroclimatology, Springer, 2018
3. P. Jayarami Reddy, A Text Book of Stochastic Hydrology, Laxmi Publications, New Delhi, 2nd edition, 2016.
4. M. L. Shelton, Hydroclimatology: Perspectives and Applications, Cambridge University Press, 2009.

References

1. IPCC, Fourth to Sixth Assessment Reports, 2016.
2. M. Karamouz, S Nasif and M Falahi. Hydrology and Hydroclimatology. CRC press, 2012
3. NT. Kottegoda, R Rosso. Applied Statistics for Civil and Environmental Engineers. Wiley Blackwell, 1997
4. KS. Raju, DN Kumar. Impact of Climate change on water resources –with modeling techniques and case studies. Springer, 2008

Course Contents and Lecture Schedule

	Topic	Cos Mapped	No. of Hours
Module I (8 Hours)			
1	Introduction-weather and climate, climate system	CO1	1
2	Climate variables-affecting precipitation- climate variables affecting precipitation, humidity, vapor pressure, saturation vapor pressure–temperature relation	CO1	2
3	Perceptible water, Forms and types of precipitation	CO1	2
4	Cloud – types, atmospheric stability	CO1	1
5	Monsoon- wind pattern in India, Indian summer monsoon rainfall- characteristics	CO1	1
6	Role of global climate oscillations on Indian monsoon rainfall- ElNino and LaNina.	CO1	1
Module II (7 Hours)			
7	Atmosphere- vertical structure	CO2	1
8	Radiation and temperature; laws of radiation	CO2	1
9	The general circulation	CO2	1
10	Random temperature variation; modeling vertical variation in air temperature	CO2	2
11	Temporal variation of air temperature	CO2	1

12	Temperature extremes, heat waves- definition	CO2	1
Module III (8 Hours)			
13	Floods- causes, types	CO3	1
14	Floods- methods of control, flood modeling	CO3	1
15	Frequency analysis of hydro climatic extremes	CO3	2
16	Return period Risk and reliability in hydrologic design- simple problems,	CO3	2
17	Droughts-types, characteristics, drought indices	CO3	2
Module IV (6 Hours)			
18	Causes of climate change	CO4	1
19	Modeling of climate hydrologic impact of climate change- typical framework	CO4	1
20	General circulation models, regional climate models	CO4	1
21	Downscaling- concept and types	CO4	1
22	IPCC reports, scenarios and databases	CO4	1
23	Uncertainty in downscaling studies	CO4	1
Module V (6 Hours)			
24	Principal component analysis	CO5	1
25	Methods for change point analysis	CO5	2
26	Methods for trend analysis	CO5	2
27	Stationary and non-stationary series- determination of non-stationarity of hydro-climatic series	CO5	1



Model Question Paper

Reg No.:.....

QP CODE:.....

Name:.....

APJ ABDUL KALAM TECHNOLOGICAL UNIVERSITY
EIGHTH SEMESTER B.TECH DEGREE EXAMINATION, MONTH & YEAR
Course Code: CET 448
Course Name: Hydroclimatology

Max. Marks: 100
hours

Duration: 3**PART A****(Answer all questions; each question carries 3 Marks)**

- | | | |
|----|--|---------|
| 1 | Differentiate weather and climate | |
| 2 | Explain the different forms of precipitation | |
| 3 | Explain temperature extremes | |
| 4 | Explain the laws of radiation | |
| 5 | Differentiate risk and reliability of hydrosystems | |
| 6 | Explain the causes of floods | |
| 7 | Write a brief description of IPCC Assessment reports | |
| 8 | What is downscaling in climate studies ? | |
| 9 | Explain change points in hydrologic series | |
| 10 | Explain stationarity and non-stationarity of hydro-climatic data | 10*3=30 |

PART B**(Answer one full question from each module, each question carries 14 Marks)****Module I**

- | | | | |
|----|----|--|-----------|
| 11 | a. | Explain precipitable water | (8 Marks) |
| | b. | Explain the role of global climate oscillations on Indian monsoon rainfall | (6 Marks) |

OR

- 12 a. Explain the different types of clouds (8 Marks)
- b. Differentiate ElNino and La Nina (6 Marks)

Module II

- 13 a. Explain the vertical structure of atmosphere with relevant sketches (10 Marks)
- b. Explain heat waves (4 Marks)

OR

- 14 a. Explain general circulation of atmosphere. Describe the triple cell general circulation model with the help of neat diagrams. (10 Marks)
- b. Explain temporal variation of air temperature (4 Marks)

Module III

- 15 a. A cofferdam has been built to protect homes in a floodplain until a major channel project can be completed. The cofferdam was built for a 20-year flood event. The channel project will require 3years to complete. What are the probabilities that
- The cofferdam will not be overtopped during the 3 years ?
 - The cofferdam will be overtopped in any one year?
 - The cofferdam will be overtopped exactly once in 3 years?
 - The cofferdam will be overtopped at least once in 3 years ?
 - The cofferdam will be overtopped only in the third year?.
- b. Explain the methods of flood control (4 Marks)

OR

- 16 a. Explain different types of droughts. (6 Marks)
- b. Explain the method of estimation of any four types of drought indices (8 Marks)

Module IV

- 17 a. Explain the causes of climate change. (8 Marks)
- b. Differentiate statistical downscaling and dynamic downscaling (6 Marks)

OR

- 18 a. Explain the typical framework for modeling the impact of climate change on water resources (8 Marks)
- b. Explain the sources of uncertainty in downscaling studies (6 Marks)

Module V

- 19 a. Explain Principal component analysis and its importance in climate change studies (5 Marks)
- b. Explain any three methods for analyzing the trend of hydrologic data (9 Marks)

OR

- 20 a. Explain thy three methods of determination of change point of hydro-climatic data (9 Marks)
- b. Explain non-stationarity detection of hydro-climatic studies (5 Marks)



CET458	SUSTAINABLE CONSTRUCTION	CATEGORY	L	T	P	CREDIT	YEAR OF INTRODUCTION
		PEC	3	0	0	3	2019

Preamble: Goal of this course is to expose the students to the fundamental concepts of sustainable building construction. After this course, students will develop an awareness on sustainable building materials and construction practices and also exposed to applications of ICT in sustainable construction.

Prerequisite: MCN 201 Sustainable Engineering

Course Outcomes: After completion of the course the student will be able to:

CO 1	Explain the fundamental concepts of sustainability
CO 2	Describe the properties and uses of sustainable building materials
CO 3	Identify suitable construction techniques and practices for sustainable buildings
CO 4	Discuss the standards and guidelines for sustainable buildings
CO 5	Comment on the role of BIM and automation in sustainable construction

Mapping of course outcomes with program outcomes (Minimum requirement)

	PO 1	PO 2	PO 3	PO 4	PO 5	PO 6	PO 7	PO 8	PO 9	PO 10	PO 11	PO 12
CO 1	2	-	-	-	-	2	3	-	-	-	-	2
CO 2	2	-	-	-	-	2	3	-	-	-	-	2
CO 3	2	-	-	-	-	2	3	-	-	-	-	2
CO 4	2	-	-	-	-	2	3	-	-	-	-	2
CO 5	2	-	-	-	-	2	3	-	-	-	-	2

Assessment Pattern

Bloom's Category	Continuous Assessment Tests		End Semester Examination (Marks)
	Test 1 (Marks)	Test 2 (Marks)	
Remember	15	15	40
Understand	35	30	50
Apply		5	10
Analyse			
Evaluate			
Create			

Mark Distribution

Total Marks	CIE Marks	ESE Marks	ESE Duration
150	50	100	3 hours

Continuous Internal Evaluation (CIE) Pattern :

Attendance	: 10 Marks
Continuous Assessment Test (2 numbers)	: 25 Marks
Assignment/Quiz/Course project	: 15 Marks

End Semester Examination (ESE) Pattern : There will be two parts; Part A and Part B. Part A contains 10 questions with 2 questions from each module, having 3 marks for each question. Students should answer all questions. Part B contains 2 questions from each module of which student should answer any one. Each question can have maximum 2 sub-divisions and carry 14 marks.

Course Level Assessment Questions

(Questions may be framed based on the outline given under each course outcome)

Course Outcome 1 (CO1):

1. The fundamental concepts of sustainability
2. Describe the features of sustainability indicators
3. Discuss the concepts of sustainability analysis

Course Outcome 2 (CO2):

1. To get a comprehensive overview of materials used for sustainable buildings
2. Identify the properties and uses of sustainable building materials
3. Discuss the role of various Govt and non-Govt organizations in promoting sustainable building materials

Course Outcome 3 (CO3):

1. Apply cost effective technologies and methods in construction
2. Discuss the role of various organizations in promoting sustainable construction practices
3. Discuss case studies pertaining to Kerala context

Course Outcome 4 (CO4):

1. Describe the features of green building rating systems
2. Discuss case studies based on green rating in Indian context

Course Outcome 5 (CO5):

1. Discuss the concepts and benefits of BIM
2. Discuss the applications of BIM in construction management
3. Identify the applications of automation for functional efficiency of buildings

Syllabus**Module 1**

Introduction to concepts of sustainability : impacts of global warming, sustainability indicators - Carbon foot print, Embodied energy and carbon, sustainability analysis - Life Cycle Analysis, EIA - Concept of Green Buildings

Module 2

Sustainable building materials : Introduction to sustainable building materials, qualities, use, examples - Natural building materials, locally available and locally manufactured materials – wood, earth, stone and lime based materials.

Contemporary Building Materials- concrete, eco block, stabilized blocks (mud blocks, steam cured blocks, Fal-G Blocks stone masonry block.), insulated concrete forms(ISF), hydra form, prefabs / structural insulating panels, cellulose insulation, adobe, rammed earth, earth sheltered and recycled materials - Bio materials : Properties, application, specification and standards(Indian and International) - Bio materials from industrial waste, mining waste, mineral waste, agricultural waste - Non toxic materials: low VOC paints, coating and adhesives - Use of waste materials such as paper, glass bottles, tires, shipping containers - Use of post-consumer and industrial waste such as fly-ash, bags, building construction &demolition waste – use of salvaged and recycled

materials from flooring, columns, beams, timber, glass, etc.

Alternative Building Materials - Overview and definition of alternative or appropriate building materials - Alternative materials developed and promoted by government organisations like CSIR labs: CBRI and SERC, GRIHA, ASTRA (IISc), BMTPC, HUDCO and its building centres - Alternative materials developed and promoted by non-government organisations DA, Auroville, TERI

Module 3

Sustainable methods & technologies—Eco friendly and low cost techniques - Different substitute for wall construction - Flemish Bond - Rat Trap Bond – Arches – Panels - Cavity Wall - Ferro Cement and Ferro Concrete constructions – different pre cast members using these materials - Alternate roofing systems - Filler Slab - Composite Beam and Panel Roof -Pre-engineered and ready to use building elements - wood products -steel and plastic –Mivan technique - Contributions of agencies - Costford - Nirmithi Kendra – Habitat

Module 4

Green building rating systems – Guidelines from IGBC – LEED rating system, TERI-GRIHA rating system.

Codes - Energy Conservation Building Code (BEE), National Building Code.

Green Building Case studies – Residential, Institutional, and Commercial.

Concept of Net Zero buildings – Use of BIPV and other renewable energy in buildings

Module 5

ICT for Sustainable Construction : Building Information modeling – Introduction to BIM, concepts and benefits, BIM for construction scheduling, cost estimation and construction management.

Building Automation – Concepts, components of BA, applications of BA for functional efficiency of buildings.

Text/Reference Books:

1. Sustainable Building - Design Manual Pt 1 & 2, The Energy and Resources Institute, TERI, 2004
2. Ross Spiegel.G, Green Building Materials A Guide to Product Selection and Specification, 3rd Edition by, John Wiley & Sons, 2010
3. Jagadish. K.S. Alternative Building Materials and Technologies, New age International Pvt Ltd Publishers, 2008
4. Traci Rose Rider, Stacy Glass, Jessica McNaughton, Understanding Green Building Materials, W.W.Norton and Company, 2011

5. BIM Handbook: A Guide to Building Information Modeling for Owners, Managers, Designers, Engineers and Contractors- Chuck Eastman, et al.
6. Automation Systems in Smart and Green Buildings (Modern Building Technology), Er. V K Jain, Khanna Publishers
7. BIS, National Building Code 2005, New Delhi, 2005
8. Energy Conservation Building Code of India, User manual, 2007
9. P.K. Singh, Rainwater Harvesting: Low cost indigenous and innovative technologies, Macmillan Publishers India, 2008
10. Jagadish. K.S. Building with stabilised mud, I.K. International Publishing House Pvt. Limited, 2007

Course Contents and Lecture Schedule:

Module	Contents	Outcomes Addressed	Hours
1	Module 1		6
1.1	Introduction to concepts of sustainability : impacts of global warming	CO 1	1
1.2	Sustainability indicators - Carbon foot print	CO 1	1
1.3	Embodied energy and carbon	CO 1	1
1.4	Sustainability analysis - Life Cycle Analysis	CO 1	1
1.5	EIA	CO 1	1
1.6	Concept of Green Buildings	CO 1	1
2	Module 2		8
2.1	Sustainable building materials : Introduction to sustainable building materials, qualities, use, examples	CO 2	1
2.2	Natural building materials, locally available and locally manufactured materials – wood, earth, stone and lime based materials	CO 2	1
2.3	Contemporary Building Materials - concrete, eco block, stabilized blocks (mud blocks, steam cured blocks, Fal-G Blocks stone masonry block.), insulated concrete forms (ISF), hydra form, prefabs / structural insulating panels, cellulose insulation, adobe, rammed earth, earth sheltered and recycled materials	CO 2	1
2.4	Bio materials : Properties, application, specification and standards (Indian and International) - Bio materials from industrial waste, mining waste, mineral waste, agricultural waste	CO 2	1
2.5	Non toxic materials: low VOC paints, coating and adhesives -	CO 2	1

	Use of waste materials such as paper, glass bottles, tires, shipping containers.		
2.6	Use of post-consumer and industrial waste such as fly-ash, bags, building construction & demolition waste – use of salvaged and recycled materials from flooring, columns, beams, timber, glass, etc.	CO 2	1
2.7	Alternative Building Materials - Overview and definition of alternative or appropriate building materials - Alternative materials developed and promoted by government organisations like CSIR labs: CBRI and SERC, GRIHA, ASTRA (IISc), BMTPC, HUDCO and its building centres	CO 2	1
2.8	Alternative materials developed and promoted by non-govt organisations DA, Auroville, TERI	CO 2	1
3	Module 3		8
3.1	Sustainable methods & technologies – Eco friendly and low-cost techniques - Different substitute for wall construction - Flemish Bond - Rat Trap Bond	CO 3	1
3.2	Arches – Panels - Cavity Wall	CO 3	1
3.3	Ferro Cement and Ferro Concrete constructions	CO 3	1
3.4	Different pre cast members using these materials - Alternate roofing systems - Filler Slab - Composite Beam and Panel Roof	CO 3	1
3.5	Pre-engineered and ready to use building elements	CO 3	1
3.6	Wood products - steel and plastic, Mivan technique	CO 3	1
3.7	Contributions of agencies - Costford	CO 3	1
3.8	Nirmithi Kendra – Habitat	CO 3	1
4	Module 4		7
4.1	Green building rating systems – Guidelines from IGBC – LEED rating system, TERI-GRIHA rating system.	CO 4	2
4.2	Codes - Energy Conservation Building Code (BEE), National Building Code.	CO 4	1
4.3	Green Building Case studies – Residential, Institutional, and Commercial.	CO 4	2
4.4	Concept of Net Zero buildings – Use of BIPV and other renewable energy in buildings	CO 4	2
5	Module 5		6
5.1	ICT for Sustainable Construction : Building Information	CO 5	1

	modeling – Introduction to BIM, concepts and benefits		
5.2	BIM for construction scheduling	CO 5	1
5.3	BIM for Cost estimation and construction management.	CO 5	1
5.4	Building Automation – Concepts	CO 5	1
5.5	Components of BA	CO 5	1
5.6	Applications of BA for functional efficiency of buildings.	CO 5	1

ABDUL KALAM
TECHNOLOGICAL
UNIVERSITY



Model Question Paper**QP CODE:****Reg No.:** _____**Name:** _____

APJ ABDUL KALAM TECHNOLOGICAL UNIVERSITY
EIGHTH SEMESTER B.TECH DEGREE EXAMINATION, MONTH & YEAR

Course Code: CET 458**Course Name : SUSTAINABLE CONSTRUCTION**

Max. Marks: 100

Duration: 3 hours

Part A*(Answer all questions; each question carries 3 marks)*

1. Discuss any one sustainability indicator
2. What is EIA? Explain its significance
3. Define eco blocks
4. Enumerate the properties of wood-based materials that make it sustainable
5. Explain pre-engineered building construction
6. Differentiate between ferrocement and ferro-concrete
7. Discuss the role of NBC in sustainable building construction
8. Describe net zero building
9. What are the benefits of BIM?
10. List the components of building automation system

PART B*(Answer one full question from each module, each question carries 14 marks)***Module – 1**

11. (a) What is embodied energy? Explain its significance. (5 Marks)
 (b) Illustrate the process of Life Cycle Analysis. (9 Marks)
12. (a) Explain the features of green buildings. (5 Marks)
 (b) Describe the methods for estimation of carbon foot print. (9 Marks)

Module – 2

13. (a) Discuss the initiatives of GRIHA in alternative materials development. (5 Marks)
 (b) List out the various types of agro and industrial wastes and explain their properties (9 Marks)
14. (a) Discuss any five sustainable materials that can be made from utilization of wastes. (5 Marks)

- (b) Elaborate the steps involved in manufacturing of stabilized mud blocks. (9 Marks)

Module – 3

15. (a) Draw the plan of odd and even courses of a corner wall comprising rat trap bond. (5 Marks)
(b) List out the merits and demerits of Mivan construction technique. (9 Marks)
16. (a) Explain the concept of filler slab roofing systems. (7 Marks)
(b) Discuss the role of Habitat in propagating cost-effective constructions. (7 Marks)

Module – 4

17. (a) Describe green building features based on a residential case study. (5 Marks)
(b) Compare the rating frameworks of LEED and GRIHA (9 Marks)
18. (a) What are the applications of building integrated photo voltaics? (5 Marks)
(b) Discuss the features of energy efficient buildings based on
(i) institutional case study (ii) commercial case study (9 Marks)

Module – 5

19. (a) Enumerate the role of building automation in energy conservation (5 Marks)
(b) Describe the implementation of BIM in construction scheduling. (9 Marks)
20. (a) Illustrate the application of building automation in water conservation (5 Marks)
(b) Explain the process of BIM in cost optimisation. (9 Marks)



CET468	CLIMATE CHANGE AND SUSTAINABILITY	CATEGORY	L	T	P	CREDIT	YEAR OF INTRODUCTION
		PEC	3	0	0	3	2019

Preamble: Goal of this course is to expose the students to the fundamental concepts of climate, its influencing factors, climate change and its relationship with sustainability. After this course, students will be able to recognize the real-world problems that can happen due to climate change, aware of the various mitigation and adaptation techniques using sustainable technologies for combating the adverse impacts due to climate change and respond accordingly.

Prerequisite: Nil

Course Outcomes: After completion of the course the student will be able to:

CO 1	Explain the fundamental concepts of climate and its influencing factors
CO 2	Explain the factors affecting climate change and the harmful impacts due to climate change
CO 3	Discuss the problems due to urbanization and the need for sustainable development
CO 4	Demonstrate the various adaptation and mitigation techniques for combating climate change
CO 5	Discuss multilateral agreements on climate change, Case studies on Climate change

Mapping of course outcomes with program outcomes (Minimum requirement)

	PO 1	PO 2	PO 3	PO 4	PO 5	PO 6	PO 7	PO 8	PO 9	PO 10	PO 11	PO 12
CO 1	2	-	-	-	-	-	-	-	-	-	-	-
CO 2	-	2	-	2	-	-	2	-	-	-	-	-
CO 3	-	3	-	3	-	-	2	-	-	-	-	-
CO 4	2	-	-	-	-	-	3	-	-	-	-	-
CO 5	-	-	-	-	-	-	2	-	-	-	-	-

Assessment Pattern

Bloom's Category	Continuous Assessment Tests		End Semester Examination (Marks)
	Test 1 (Marks)	Test 2 (Marks)	
Remember	20	20	40
Understand	20	20	40
Apply	10	10	20
Analyze			
Evaluate			
Create			

Mark Distribution

Total Marks	CIE Marks	ESE Marks	ESE Duration
150	50	100	3 hours

Continuous Internal Evaluation (CIE)Pattern :

Attendance	: 10 Marks
Continuous Assessment Test (2 numbers)	: 25 Marks
Assignment/Quiz/Course project	: 15 Marks

End Semester Examination (ESE)Pattern : There will be two parts; Part A and Part B. Part A contains 10 questions with 2 questions from each module, having 3 marks for each question. Students should answer all questions. Part B contains 2 questions from each module of which student should answer any one. Each question can have maximum 2 sub-divisions and carry 14 marks.

Course Level Assessment Questions

(Questions may be framed based on the outline given under each course outcome)

CO1: Explain the fundamental concepts of climate and its influencing factors

1. What is atmospheric stability?
2. Explain in detail the factors influencing climate.
3. Discuss how inversions are formed.

CO2: Explain the factors affecting climate change and the harmful impacts due to climate change

1. Explain vulnerability index.
2. Discuss the impact of climate change on agriculture.
3. What are the anthropogenic drivers of climate change?

CO3: Discuss the problems due to urbanization and the need for sustainable development

1. Explain urban heat islands.
2. What are the causes for urban floods?
3. Discuss how life cycle analysis helps in sustainable development.

CO4: Demonstrate the various adaptation and mitigation techniques for combating climate change

1. How green engineering can help in combating climate change?
2. Explain circular economy
3. Discuss nature based solutions in disaster management.

CO5: Discuss multilateral agreements on climate change, Case studies on Climate change

1. What is Clean Development Mechanism?
2. How emission trading helps fighting climate change?
3. Explain Kyoto mechanisms to reduce GHG emissions.

Syllabus**Module 1****Climate**

Climate and weather, Meteorology and climatology, Composition and structure of atmosphere. Factors influencing climate-Insolation, Temperature, Humidity, Pressure, Wind, Precipitation, Topography. Atmospheric stability, Lapse rate, Inversions, Types of inversions. Cyclones and Anticyclones.

Module 2**Climate change**

Climate change, anthropogenic drivers of climate change, Global warming, Green house effect, Air pollution, carbon foot print, Impact of climate change on water cycle, agriculture, forest, water resources, urban areas, biodiversity, human health. Carbon sequestration , vulnerability index.

Module 3

Urbanisation and Sustainable development

Urbanisation and Industrialization, Urbanisation, problems of urbanisation, Urban sprawl, Urban heat islands, causes, mitigation measures. Urban flooding, water conservation and ecological aspects. Urban Planning, Zoning of Land Use

Pillars of Sustainable development, Sustainability indicators, Life cycle analysis, Material flow analysis, Green energy, Waste management, 3R concepts, Sustainable cities, Sustainable Urbanisation

Module 4

Adaptation and mitigation strategies

Green Engineering, Design for Engineering, Green technologies, Circular economy. Planning of cities as climate resilient, Climate change and infrastructure planning, Climate resilient infrastructure, nature based solutions in disaster management, adaptation strategies for combating climate change

Module 5

Climate and sustainability

Sustainability Engineering , Kyoto mechanisms to reduce GHG emission- Clean Development Mechanism, Joint Implementation, Emission trading, Case studies on Kyoto mechanism, Case studies on climate change and climate change risk reduction.

Text/Reference Books

- Lal, DS, “Climatology”, Published by Sharda Pustak Bhawan, ISBN8186204121
- John T. Hardy, Jean Ponce, “Climate Change - Causes, Effects, and Solutions”, Wiley Publications, 2003
- Jonathan Tomkin, Tom Theis, "Sustainability - A Comprehensive Foundation", 12th Media Services, 2018
- Karthik Karuppu, "Green Building Guidance: The Ultimate Guide for IGBC Accredited Professional Examination Book", NVICO Notion Press, 2019
- Keith D. Alverson, ZintaZommers, "Resilience : The science of adaptation to climate change", Elsevier, 2018
- Leal Filho, W., Azul, A.M., Brandli, L., Özuyar, P.G., Wall, T. (Eds.), “Sustainable Cities and Communities” Springer
- Intergovernmental Panel on Climate Change (IPCC) reports

Course contents and Lecture schedule

Module	Topic	Course Outcomes addressed	No. of Lectures
1	Module 1: Total Lecture Hours -7		
1.1	Climate and weather, Meteorology and climatology, Composition and structure of atmosphere.	CO1	1
1.2	Factors influencing climate-Insolation, Temperature, Humidity, Pressure, Wind, Precipitation, Topography.	CO1	2
1.3	Atmospheric stability, Lapse rate, Inversions, Types of inversions.	CO1	3
1.4	Cyclones and Anticyclones.	CO1	1
2	Module II: Total Lecture Hours- 7		
2.1	Climate change, anthropogenic drivers of climate change	CO2	1
2.2	Global warming, Green house effect, Air pollution, carbon foot print,	CO2	2
2.3	Impact of climate change on water cycle, agriculture, forest, water resources, urban areas, biodiversity, human health.	CO2	3
2.4	Carbon sequestration , vulnerability index.	CO2	2
3	Module III: Total Lecture Hours-7		
3.1	Urbanisation and Industrialization, Urbanisation, problems of urbanisation, Urban sprawl, Urban heat islands, causes, mitigation measures.	CO3	2
3.2	Urban flooding, water conservation and ecological aspects. Urban Planning, Zoning of Land Use	CO3	1
3.3	Pillars of Sustainable development, Sustainability indicators,	CO3	1
3.4	Life cycle analysis, Material flow analysis,	CO3	1
3.5	Green energy, Waste management, 3R concepts,	CO3	1
3.6	Sustainable cities, Sustainable Urbanisation	CO3	1
4	Module IV: Total Lecture Hours- 7		

4.1	Green Engineering, Design for Engineering, Green technologies	CO4	2
4.2	Circular economy	CO4	1
4.3	Planning of cities as climate resilient, Climate change and infrastructure planning, Climate resilient infrastructure.	CO4	2
4.4	Nature based solutions in disaster management	CO4	1
4.5	Adaptation strategies for combating climate change	CO4	1
5	Module V: Total Lecture Hours- 7		
5.1	Sustainability Engineering , Kyoto mechanisms to reduce GHG emission, Case studies on Kyoto mechanism.	CO4	3
5.2	Clean Development Mechanism, Joint Implementation, Emission trading	CO3, CO4	2
5.3	Case studies on climate change and climate change risk reduction	CO4	2



Model Question Paper

Reg No.: _____

Name: _____

**APJ ABDUL KALAM TECHNOLOGICAL UNIVERSITY
EIGHTH SEMESTER B.TECH DEGREE EXAMINATION****Course Code: CET 468****Course Name: CLIMATE CHANGE & SUSTAINABILITY**

Max. Marks: 100

Duration: 3 Hours

Part A*(Answer all questions; each question carries 3 marks)*

1. Explain lapse rate.
2. How climate is different from weather.
3. What is carbon footprint?
4. Explain carbon sequestration.
5. Explain urban sprawl.
6. What is 3R concept in waste management?
7. What is a climate resilient city?
8. How adaptation and mitigation strategies are different?.
9. Explain CDM.
10. What is emission trading?

PART B*(Answer one full question from each module, each question carries 14 marks)*

11. (a) Discuss how inversions are formed. What are different types of inversion? (7 Marks)
(b) Describe the composition and structure of atmosphere with a neat sketch .(7 Marks)

OR

12. (a) Explain in detail the factors influencing climate (8 Marks)
(b) Compare cyclones and anticyclones ? (6 Marks)
13. (a) Discuss the impact of climate change on agriculture (8 Marks)

(d) Explain vulnerability index (6 Marks)

OR

14. (a) What are the anthropogenic drivers for climate change? (8 Marks)

(b) Explain Green house effect. How it influence climate? (6 Marks)

15. (a) What is urban heat island? What are the causes? (8 Marks)

(b) Explain life cycle analysis. (6 Marks)

OR

16. (a) Discuss the causes and mitigation measures for urban flood (7 Marks)

(b) Explain the pillars of sustainable development (7 Marks)

17. (a) Explain how green technologies help in combating climate change.
(7Marks)

(b) Discuss nature based solutions in disaster management. (7 marks)

OR

18. (a) Explain how circular economy concepts helps in climate change mitigation (7 Marks)

(b) What are the factors to consider while designing a climate resilient city? (7 Marks)

19. (a) Explain Kyoto mechanisms to reduce GHG emissions (7 Marks)

(b) How emission trading is effective as a climate change reduction strategy? (7 Marks)

OR

20. Elaborate climate change reduction strategies with an example case study (14 Marks)

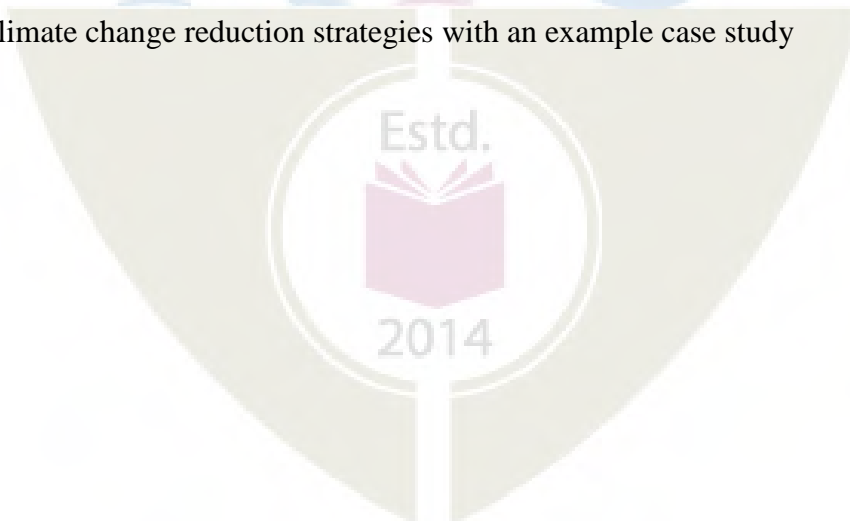

CET478	BUILDING INFORMATION MODELLING	CATEGORY	L	T	P	CREDIT	YEAR OF INTRODUCTION
		PEC	3	0	0	3	2019

Preamble: Goal of this course is to expose the students to the use of Building Information Modelling in building construction projects. Students will learn terminology associated with buildings, the theory and evolution of BIM, and how to develop BIM models using software like Autodesk Revit.

Prerequisite : CEL 334 Civil Engineering Software Lab

Course Outcomes: After completion of the course the student will be able to:

CO 1	Explain the concept and advantages of BIM
CO 2	Apply the various processes on a BIM model
CO 3	Appraise the collaborative and interoperability capabilities of BIM
CO 4	Explain BIM execution plan
CO 5	Explain the principles of integrated project delivery

Mapping of course outcomes with program outcomes (Minimum requirement)

	PO 1	PO 2	PO 3	PO 4	PO 5	PO 6	PO 7	PO 8	PO 9	PO 10	PO 11	PO 12
CO 1	1	-	-	-	-	1	-	-	-	-	-	-
CO 2	1	-	1	-	1	-	-	-	-	-	-	-
CO 3	1	-	1	-	1	-	-	-	3	3	-	-
CO 4	1	-	1	-	1	-	-	-	3	-	3	-
CO 5	1	-	1	-	1	-	-	-	3	3	-	-

Assessment Pattern

Bloom's Category	Continuous Assessment Tests		End Semester Examination (Marks)
	Test 1 (Marks)	Test 2 (Marks)	
Remember	10	10	30
Understand	20	25	40
Apply	10	5	10
Analyse	10	10	20
Evaluate			
Create			

Mark Distribution

Total Marks	CIE Marks	ESE Marks	ESE Duration
150	50	100	3 hours

Continuous Internal Evaluation (CIE)Pattern :

Attendance : 10 Marks

Continuous Assessment Test (2 numbers) : 25 Marks

Software assignments : 15 Marks

End Semester Examination (ESE)Pattern : There will be two parts; Part A and Part B. Part A contains 10 questions with 2 questions from each module, having 4 marks for each question. Students should answer all questions. Part B contains 2 questions from 1st, 3rd, 4th and 5th module of which student should answer any one. Each question can have maximum 2 sub-divisions and carry 15 marks.

Course Level Assessment Questions

(Questions may be framed based on the outline given under each course outcome)

Course Outcome 1 (CO1):

1. Identify the inadequacies of traditional construction and planning practices
2. How construction practices can be improved by BIM
3. Evolution and development of BIM from its origin to today

4. Concept of BIM as a lifecycle platform

Course Outcome 2 (CO2):

1. Proficiency in various tools provided by Revit software
2. Proficiency in various software that make up 5D BIM

Course Outcome 3 (CO3):

1. BIM and collaboration between construction stakeholders
2. Explain types of Data Exchange Methods
3. Appraisal of BIM guides

Course Outcome 4 (CO4):

1. How to identify and resolve issues in model
2. Benefits of BIM project execution plans
3. List the project goals that can be served by BIM uses
4. Explain BIM overview and BIM use maps

Course Outcome 5 (CO5):

1. What are the principles of Integrated Project Delivery?

Syllabus

Module 1

Introduction to BIM

Traditional AEC Business Model and its inefficiencies

What is BIM? – BIM vs 3D vs 2D – BIM as a product vs BIM as a process

BIM as a lifecycle platform

Why BIM – incentives and benefits – technical and financial.

The Evolution to Object-Based Parametric Modeling

BIM Model Quality and Model Checking

Module 2**BIM software training**

Create Modeling Views - Model Layout - Architectural Modeling-Structural Modeling-MEP Modeling-Construction Modeling - Project Management - Revit Families - Tools and Techniques - Project Phasing - Document and Present the Design -Analyze the Design (Energy, solar, area, etc.) – Schedules - Rendering – Walkthroughs

(Topics have to be discussed and demonstrated with the help of software at the Laboratory; Each topic will be an assignment in each week. Theory classes may progress with the other modules.)

Module 3**Collaboration, Interoperability and roles**

BIM for stakeholders - Owners , Facility Managers and Government Institutions , Architects and Engineers, Contractors, Subcontractors and Fabricators.

BIM Adoption, Maturity Levels

BIM Guides (From countries like Finland, Denmark, Belgium etc)

Data Exchange Methods – File based, Cloud based and local data exchange methods

Product Data Models and Standardization

File-Based Exchange and BIM Servers, IFC – Industry Foundation classes, COBie

Module 4**BIM Execution Plan**

Overview of the BIM Execution Planning Procedure for Building Information Modeling

Establish Project Modeling Goals

Select Model Uses

Design the BIM Process

Define the Information Exchanges

Plan Infrastructure

Implementing the BIM Project Execution Planning Procedure

BIM Project Execution Planning for Organizations

Conclusions and Recommendations

Module 5

Integrated Project Delivery

Principles of Integrated Project Delivery - Mutual Respect and Trust ,Mutual Benefit and Reward, Collaborative Innovation and Decision Making, Early Involvement of Key Participants, Early Goal Definition, Intensified Planning, Open Communication, Appropriate Technology, Organization and Leadership

Setting Up an Integrated Project - IPD Team Building and Functioning, Defining Roles, Responsibilities and Scopes of Services, Defining and Measuring Project Outcomes

Delivering an Integrated Project- Building an Integrated Team, Project Execution / Redefining Project Phases

Text/Reference Books:

1. BIM Handbook: A Guide to Building Information Modeling for Owners, Managers, Designers, Engineers and Contractors by Eastman, Chuck; Tiecholz, Paul; Sacks, Rafael; Liston, Kathleen
2. BIM Project Execution Planning Guide, Version 3.0 by John Messner, ChimayAnumba, Craig Dubler, Sean Goodman, Colleen Kasprzak, Ralph Kreider, Robert Leicht, Chitwan Saluja, NevenaZikic, and Sagata Bhawani
3. Integrated Project Delivery: A Guide by AIA
4. Autodesk Revit: User Guide by Autodesk

Course Contents and Lecture Schedule:

Module	Contents	Outcomes Addressed	Hours
1	Module 1		7
1.1	Traditional AEC Business Model and its inefficiencies	CO 1	1
1.2	What is BIM? – BIM vs 3D vs 2D – BIM as a product vs BIM as a process	CO 1	1
1.3	BIM as a lifecycle platform – Applications of BIM in the entire lifecycle of a building	CO 1 & CO 2	2
1.4	Why BIM – incentives and benefits – technical and financial	CO 1 &CO 3	1

1.5	The Evolution to Object-Based Parametric Modeling	CO 1	1
1.6	BIM Model Quality and Model Checking	CO 1	1
2	Module 2		8
2.1	Create Modeling Views - Model Layout	CO 2	1
2.2	Architectural Modeling	CO 2	1
2.3	Structural Modeling	CO 2	
2.4	MEP Modeling	CO 2	1
2.5	Construction Modeling - Project Management	CO 2	1
2.6	Revit Families - Tools and Techniques	CO 2	1
2.7	Project Phasing - Document and Present the Design	CO 2	1
2.8	Analyze the Design (Energy, solar, area, etc.)	CO 2	1
2.9	Schedules - Rendering – Walkthroughs	CO 2	1
3	Module 3		7
3.1	BIM for stakeholders - Owners , Facility Managers and Government Institutions , Architects and Engineers, Contractors, Subcontractors and Fabricators.	CO 1& CO 3	2
3.2	BIM Adoption, Maturity Levels	CO 1	1
3.3	BIM Guides (From countries like Finland, Denmark, Belgium etc)	CO 1	1
3.4	Data Exchange Methods – File based, Cloud based and local data exchange methods	CO 3	1
3.5	Product Data Models and Standardization	CO 2	1
3.6	File-Based Exchange and BIM Servers, IFC – Industry Foundation classes, COBie	CO 3	1
4	Module 4		7
4.1	Overview of the BIM Execution Planning Procedure for Building Information Modeling	CO 1& CO 4	1
4.2	Establish Project Modeling Goals	CO 4	1

4.3	Select Model Uses Design the BIM Process	CO 4	1
4.4	Define the Information Exchanges	CO 4	1
4.5	Plan Infrastructure	CO 4	1
4.6	Implementing the BIM Project Execution Planning Procedure	CO 4	1
4.7	BIM Project Execution Planning for Organizations, Conclusions and Recommendations	CO 4	1
5	Module 5		7
5.1	Principles of Integrated Project Delivery - Mutual Respect and Trust , Mutual Benefit and Reward ,Collaborative Innovation and Decision Making , Early Involvement of Key Participants, Early Goal Definition, Intensified Planning, Open Communication, Appropriate Technology, Organization and Leadership	CO 5	1
5.2	Setting Up an Integrated Project - IPD Team Building and Functioning, Defining Roles, Responsibilities and Scopes of Services, Defining and Measuring Project Outcomes	CO 5	4
5.3	Delivering an Integrated Project -Building an Integrated Team, Project Execution / Redefining Project Phases	CO 5	2

Model Question Paper**QP CODE:****Reg No.:** _____**Name:** _____

APJ ABDUL KALAM TECHNOLOGICAL UNIVERSITY
EIGHTH SEMESTER B.TECH DEGREE EXAMINATION, MONTH & YEAR

Course Code: CET478**Course Name: BUILDING INFORMATION MODELLING**

Max. Marks: 100

Duration: 3 hours

Part A*(Answer all questions; each question carries 4 marks)*

1. Write a short note on the history of BIM
2. How is BIM a lifecycle process?
3. State the tools used in structural modelling in BIM.
4. List the tools in REVIT used to do architectural modelling.
5. Explain the various maturity Levels of BIM
6. Write short note on IFC
7. List the BIM model uses in various project phases.
8. How is the Information Exchange worksheet designed?
9. Describe examples of standardized clash detection tests that might be saved and repeated across many projects.
10. Describe the types of viewpoints that would focus on primary concerns of different stakeholders?

PART B*(Answer one full question from each module, each question carries 15 marks)***Module – 1**

11. (a) What are the technical and financial incentives of using BIM? (10 Marks)
- (b) How is BIM different from 2D and 3D CAD (5 Marks)

12. Explain BIM model checking with respect to its 5 phases (15 Marks)

Module – 3

13. Differentiate between File based, Cloud based and Local Data exchange methods in BIM (15 Marks)

14. Explain the importance of BIM for each stakeholders - Owners , Facility Managers and Government Institutions , Architects and Engineers, Contractors, Subcontractors and Fabricators (15 Marks)

Module – 4

17. (a) Why should the project team develop a BIM Project Execution Plan (5 Marks)
(b) Outline and discuss the 5 step procedure to develop a detailed BEP. (10 Marks)

18. Explain in detail how the Information Exchange worksheet is designed? (15 Marks)

Module – 5

19. Explain the principles of integrated project delivery (15 Marks)
20. Define the roles, responsibilities and scope of services of the integrated project delivery stakeholders (15 Marks)



APJ ABDUL KALAM
TECHNOLOGICAL
UNIVERSITY

SEMESTER VIII

MINOR



CED482	MINI PROJECT	CATEGORY	L	T	P	CREDIT
		PWS	0	0	3	4

Preamble: Mini Project Phase I: A Project topic must be selected either from research literature or the students themselves may propose suitable topics in consultation with their guides. The object of Project Work I is to enable the student to take up investigative study in the broad field of Civil Engineering, either fully theoretical/practical or involving both theoretical and practical work to be assigned by the Department on a group of three/four students, under the guidance of a Supervisor. This is expected to provide a good initiation for the student(s) in R&D work. The assignment to normally include:

- ◆ Survey and study of published literature on the assigned topic;
- ◆ Preparing an Action Plan for conducting the investigation, including team work;
- ◆ Working out a preliminary Approach to the Problem relating to the assigned topic;
- ◆ Block level design documentation
- ◆ Conducting preliminary Analysis/ Modelling/ Simulation/ Experiment/ Design/ Feasibility;
- ◆ Preparing a Written Report on the Study conducted for presentation to the Department;

CO1	Identify and synthesize problems and propose solutions to them.
CO2	Prepare work plan and liaison with the team in completing as per schedule.
CO3	Validate the above solutions by theoretical calculations and through experimental
CO4	Write technical reports and develop proper communication skills.
CO5	Present the data and defend ideas.

Mapping of course outcomes with program outcomes

	PO1	PO2	PO3	PO4	PO5	PO6	PO7	PO8	PO9	PO10	PO11	PO12
CO1	3	3	3	3					3	3		2
CO2	3			3				3	3	3	3	
CO3	3	3	3	3	3					3		
CO4					3			3	3	3		1
CO5	3	3	3	3				3		3	3	1

*1-slight/low mapping, 2- moderate/medium mapping, 3-substantial/high mapping

Assessment Pattern

The End Semester Evaluation (ESE) will be conducted as an internal evaluation based on the product, the report and a viva- voce examination, conducted by a 3-member committee appointed by Head of the Department comprising HoD or a senior faculty member, academic coordinator for that program and project guide/coordinator. The Committee will be evaluating the level of completion and demonstration of functionality/specifications, presentation, oral examination, working knowledge and involvement.

The Continuous Internal Evaluation (CIE) is conducted by evaluating the progress of the mini project through minimum of TWO reviews. At the time of the 1st review, students are supposed to propose a new system/design/idea, after completing a thorough literature study of the existing systems under their chosen area. In the 2nd review students are expected to highlight the implementation details of the proposed solution. The review committee should assess the extent to which the implementation reflects the proposed design. A well coded, assembled and completely functional product is the expected output at this stage. The final CIE mark is the average of 1st and 2nd review marks.

A zeroth review may be conducted before the beginning of the project to give a chance for the students to present their area of interest or problem domain or conduct open brain storming sessions for innovative ideas. Zeroth review will not be a part of the CIE evaluation process.

Marks Distribution

Total Marks	CIE	ESE
150	75	75

Continuous Internal Evaluation Pattern:

Attendance : 10 marks
Marks awarded by Guide : 15 marks
Project Report : 10 marks
Evaluation by the Committee : 40 Marks

End Semester Examination Pattern: The following guidelines should be followed regarding award of marks.

- (a) Demonstration : 50 Marks
- (b) Project report : 10 Marks
- (d) Viva voce : 15marks

Course Plan

In this course, each group consisting of three/four members is expected to design and develop a moderately complex software/hardware system with practical applications. This should be a working model. The basic concept of product design may be taken into consideration.

Students should identify a topic of interest in consultation with Faculty-in-charge of miniproject/Advisor. Review the literature and gather information pertaining to the chosen topic. State the objectives and develop a methodology to achieve the objectives. Carryout the design/fabrication or develop codes/programs to achieve the objectives. Demonstrate the novelty of the project through the results and outputs. The progress of the mini project is evaluated based on a minimum of two reviews.

The review committee may be constituted by the Head of the Department. A project report is required at the end of the semester. The product has to be demonstrated for its full design specifications. Innovative design concepts, reliability considerations, aesthetics/ergonomic aspects taken care of in the project shall be given due weight.



APJ ABDUL KALAM
TECHNOLOGICAL
UNIVERSITY

SEMESTER VIII
HONOURS



CED496	MINI PROJECT	CATEGORY	L	T	P	CREDIT
		PWS	0	0	3	4

Preamble: Mini Project Phase I: A Project topic must be selected either from research literature or the students themselves may propose suitable topics in consultation with their guides. The object of Project Work I is to enable the student to take up investigative study in the broad field of Civil Engineering, either fully theoretical/practical or involving both theoretical and practical work to be assigned by the Department on a group of three/four students, under the guidance of a Supervisor. This is expected to provide a good initiation for the student(s) in R&D work. The assignment to normally include:

- ◆ Survey and study of published literature on the assigned topic;
- ◆ Preparing an Action Plan for conducting the investigation, including team work;
- ◆ Working out a preliminary Approach to the Problem relating to the assigned topic;
- ◆ Block level design documentation
- ◆ Conducting preliminary Analysis/ Modelling/ Simulation/ Experiment/ Design/ Feasibility;
- ◆ Preparing a Written Report on the Study conducted for presentation to the Department;

CO1	Identify and synthesize problems and propose solutions to them.
CO2	Prepare work plan and liaison with the team in completing as per schedule.
CO3	Validate the above solutions by theoretical calculations and through experimental
CO4	Write technical reports and develop proper communication skills.
CO5	Present the data and defend ideas.

Mapping of course outcomes with program outcomes

	PO1	PO2	PO3	PO4	PO5	PO6	PO7	PO8	PO9	PO10	PO11	PO12
CO1	3	3	3	3					3	3		2
CO2	3			3				3	3	3	3	
CO3	3	3	3	3	3					3		
CO4					3			3	3	3		1
CO5	3	3	3	3				3		3	3	1

*1-slight/low mapping, 2- moderate/medium mapping, 3-substantial/high mapping

Assessment Pattern

The End Semester Evaluation (ESE) will be conducted as an internal evaluation based on the product, the report and a viva- voce examination, conducted by a 3-member committee appointed by Head of the Department comprising HoD or a senior faculty member, academic coordinator for that program and project guide/coordinator. The Committee will be evaluating the level of completion and demonstration of functionality/specifications, presentation, oral examination, working knowledge and involvement.

The Continuous Internal Evaluation (CIE) is conducted by evaluating the progress of the mini project through minimum of TWO reviews. At the time of the 1st review, students are supposed to propose a new system/design/idea, after completing a thorough literature study of the existing systems under their chosen area. In the 2nd review students are expected to highlight the implementation details of the proposed solution. The review committee should assess the extent to which the implementation reflects the proposed design. A well coded, assembled and completely functional product is the expected output at this stage. The final CIE mark is the average of 1st and 2nd review marks.

A zeroth review may be conducted before the beginning of the project to give a chance for the students to present their area of interest or problem domain or conduct open brain storming sessions for innovative ideas. Zeroth review will not be a part of the CIE evaluation process.

Marks Distribution

Total Marks	CIE	ESE
150	75	75

Continuous Internal Evaluation Pattern:

Attendance : 10 marks
Marks awarded by Guide : 15 marks
Project Report : 10 marks
Evaluation by the Committee : 40 Marks

End Semester Examination Pattern: The following guidelines should be followed regarding award of marks.

- (a) Demonstration : 50 Marks
- (b) Project report : 10 Marks
- (d) Viva voce : 15marks

Course Plan

In this course, each group consisting of three/four members is expected to design and develop a moderately complex software/hardware system with practical applications. This should be a working model. The basic concept of product design may be taken into consideration.

Students should identify a topic of interest in consultation with Faculty-in-charge of miniproject/Advisor. Review the literature and gather information pertaining to the chosen topic. State the objectives and develop a methodology to achieve the objectives. Carryout the design/fabrication or develop codes/programs to achieve the objectives. Demonstrate the novelty of the project through the results and outputs. The progress of the mini project is evaluated based on a minimum of two reviews.

The review committee may be constituted by the Head of the Department. A project report is required at the end of the semester. The product has to be demonstrated for its full design specifications. Innovative design concepts, reliability considerations, aesthetics/ergonomic aspects taken care of in the project shall be given due weight.

